

- N-Channel Application-Specific MOSFETs
- Ideal for CPU Core DC-DC Converters
- Low Conduction Losses
- Low Switching Losses
- Minimizes Parallel MOSFETs for high current applications
- 100% R_G Tested

Description

This new device employs advanced HEXFET Power MOSFET technology to achieve an unprecedented balance of on-resistance and gate charge. The reduced conduction and switching losses make it ideal for high efficiency DC-DC converters that power the latest generation of microprocessors.

The IRF7811AV has been optimized for all parameters that are critical in synchronous buck converters including R_{DS(on)}, gate charge and Cdv/dt-induced turn-on immunity. The IRF7811AV offers an extremely low combination of Q_{sw} & R_{DS(on)} for reduced losses in both control and synchronous FET applications.

The package is designed for vapor phase, infra-red, convection, or wave soldering techniques. Power dissipation of greater than 2W is possible in a typical PCB mount application.

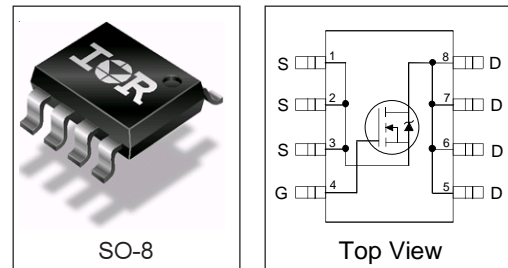

DEVICE CHARACTERISTICS ⑤

	IRF7811AV
R _{DS(on)}	11 mΩ
Q _G	17 nC
Q _{sw}	6.7 nC
Q _{oss}	8.1 nC

Absolute Maximum Ratings

Parameter	Symbol	IRF7811AV	Units
Drain-to-Source Voltage	V _{DS}	30	V
Gate-to-Source Voltage	V _{GS}	±20	
Continuous Output Current (V _{GS} ≥ 4.5V)	T _A = 25°C	10.8	A
	T _L = 90°C	11.8	
Pulsed Drain Current ①	I _{DM}	100	
Power Dissipation ③	T _A = 25°C	2.5	W
	T _L = 90°C	3.0	
Junction & Storage Temperature Range	T _J , T _{STG}	-55 to 150	°C
Continuous Source Current (Body Diode)	I _S	2.5	A
Pulsed Source Current ①	I _{SM}	50	

Thermal Resistance

Parameter	Symbol	Typ	Max	Units
Maximum Junction-to-Ambient ③⑥	R _{θJA}	—	50	°C/W
Maximum Junction-to-Lead ⑥	R _{θJL}	—	20	

Electrical Characteristics

Parameter	Symbol	Min	Typ	Max	Units	Conditions
Drain-to-Source Breakdown Voltage	$V_{(BR)DSS}$	30	—	—	V	$V_{GS} = 0V, I_D = 250\mu A$
Static Drain-to-Source On-Resistance	$R_{DS(on)}$	—	11	14	m Ω	$V_{GS} = 4.5V, I_D = 15A$ ②
Gate Threshold Voltage	$V_{GS(th)}$	1.0	—	3.0	V	$V_{DS} = V_{GS}, I_D = 250\mu A$
Drain-to-Source Leakage Current	I_{DSS}	—	—	50	μA	$V_{DS} = 30V, V_{GS} = 0V$
		—	—	20	μA	$V_{DS} = 24V, V_{GS} = 0V$
		—	—	100	μA	$V_{DS} = 24V, V_{GS} = 0V, T_J = 100^\circ C$
Gate-to-Source Leakage Current	I_{GSS}	—	—	± 100	nA	$V_{GS} = \pm 20V$
Total Gate Charge, Control FET	Q_g	—	17	26	nC	$V_{DS} = 24V, I_D = 15A, V_{GS} = 5.0V$ $V_{GS} = 5.0V, V_{DS} < 100mV$ $V_{DS} = 16V, I_D = 15A$
Total Gate Charge, Synch FET	Q_g	—	14	21		
Pre-V _{th} Gate-to-Source Charge	Q_{gs1}	—	3.4	—		
Post-V _{th} Gate-to-Source Charge	Q_{gs2}	—	1.6	—		
Gate-to-Drain ("Miller") Charge	Q_{gd}	—	5.1	—		
Switch Charge ($Q_{gs2} + Q_{gd}$)	Q_{SW}	—	6.7	—		
Output Charge	Q_{OSS}	—	8.1	12		
Gate Resistance	R_G	0.5	—	4.4	Ω	
Turn-On Delay Time	$t_{d(on)}$	—	8.6	—	ns	$V_{DD} = 16V$ $I_D = 15A$ $V_{GS} = 5.0V$ Clamped Inductive Load
Rise Time	t_r	—	21	—		
Turn-Off Delay Time	$t_{d(off)}$	—	43	—		
Fall Time	t_f	—	10	—		
Input Capacitance	C_{iss}	—	1801	—	pF	$V_{GS} = 0V$ $V_{DS} = 10V$
Output Capacitance	C_{oss}	—	723	—		
Reverse Transfer Capacitance	C_{rss}	—	46	—		

Diode Characteristics

Parameter	Symbol	Min	Typ	Max	Units	Conditions
Diode Forward Voltage	V_{SD}	—	—	1.3	V	$T_J = 25^\circ C, I_S = 15A$ ②, $V_{GS} = 0V$
Reverse Recovery Charge ④	Q_{rr}	—	50	—	nC	$di/dt = 700A/\mu s$ $V_{DD} = 16V, V_{GS} = 0V, I_D = 15A$
Reverse Recovery Charge (with Parallel Schottky) ④	Q_{rr}	—	43	—	nC	$di/dt = 700A/\mu s$, (with 10BQ040) $V_{DD} = 16V, V_{GS} = 0V, I_D = 15A$

Notes:

- ① Repetitive rating; pulse width limited by max. junction temperature.
- ② Pulse width $\leq 400 \mu s$; duty cycle $\leq 2\%$.
- ③ When mounted on 1 inch square copper board, $t < 10$ sec.
- ④ Typ = measured - Q_{oss}
- ⑤ Typical values of $R_{DS(on)}$ measured at $V_{GS} = 4.5V$, Q_g , Q_{SW} and Q_{OSS} measured at $V_{GS} = 5.0V$, $I_F = 15A$.
- ⑥ R_θ is measured at T_J approximately $90^\circ C$

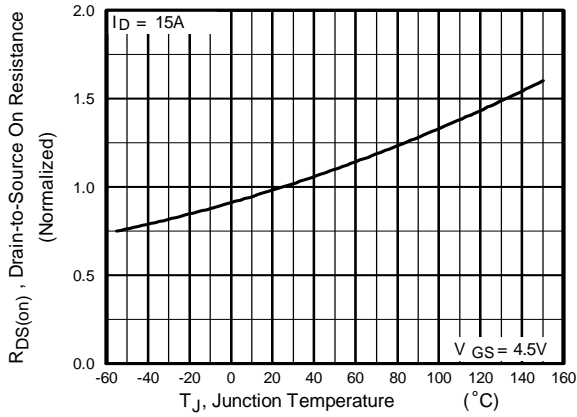

Figure 1. Normalized On-Resistance vs. Temperature

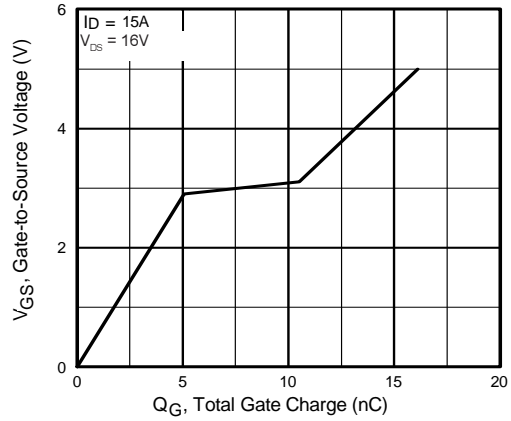

Figure 2. Gate-to-Source Voltage vs. Typical Gate Charge

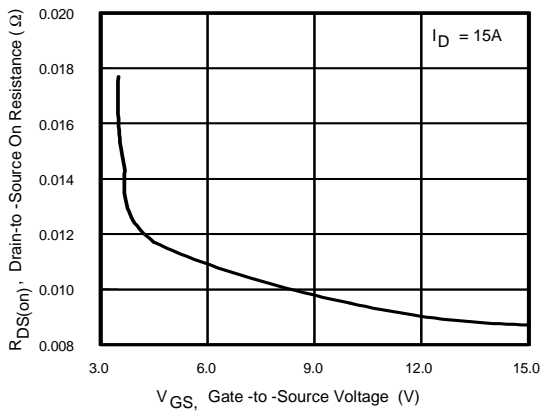

Figure 3. Typical $R_{DS(on)}$ vs. Gate-to-Source Voltage

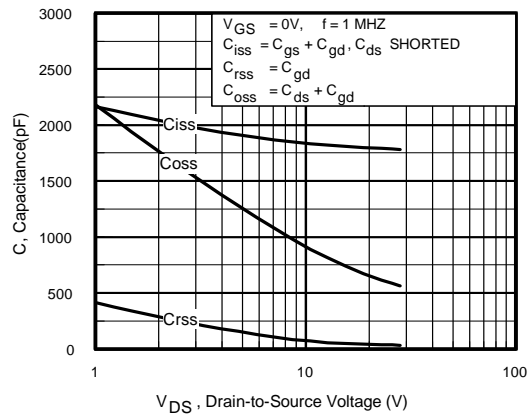

Figure 4. Typical Capacitance vs. Drain-to-Source Voltage

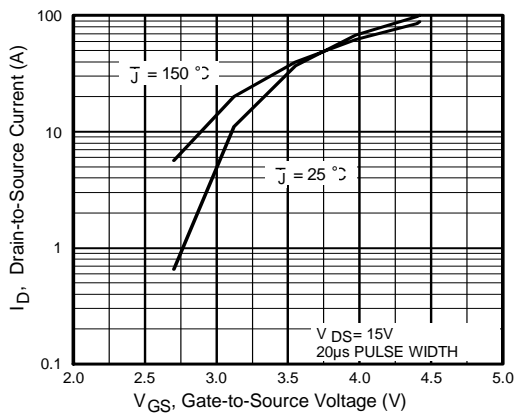

Figure 5. Typical Transfer Characteristics

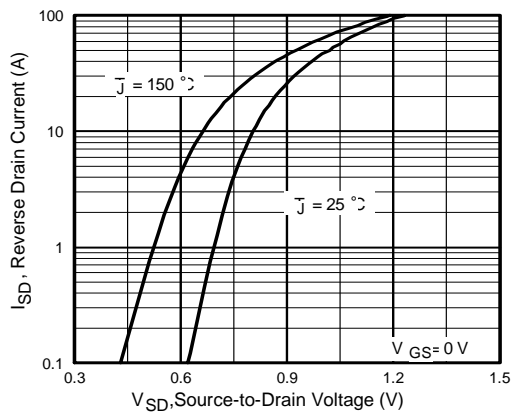

Figure 6. Typical Source-Drain Diode Forward Voltage

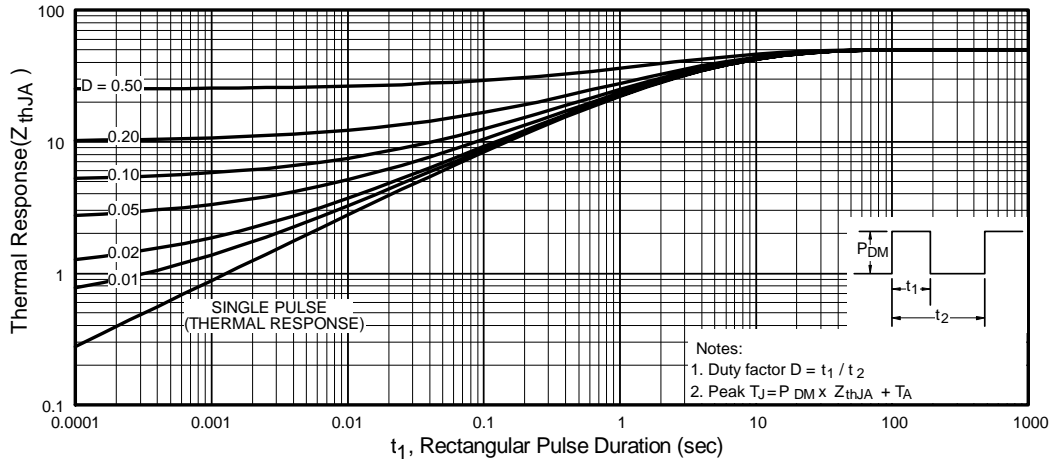

Figure 7. Maximum Effective Transient Thermal Impedance, Junction-to-Ambient

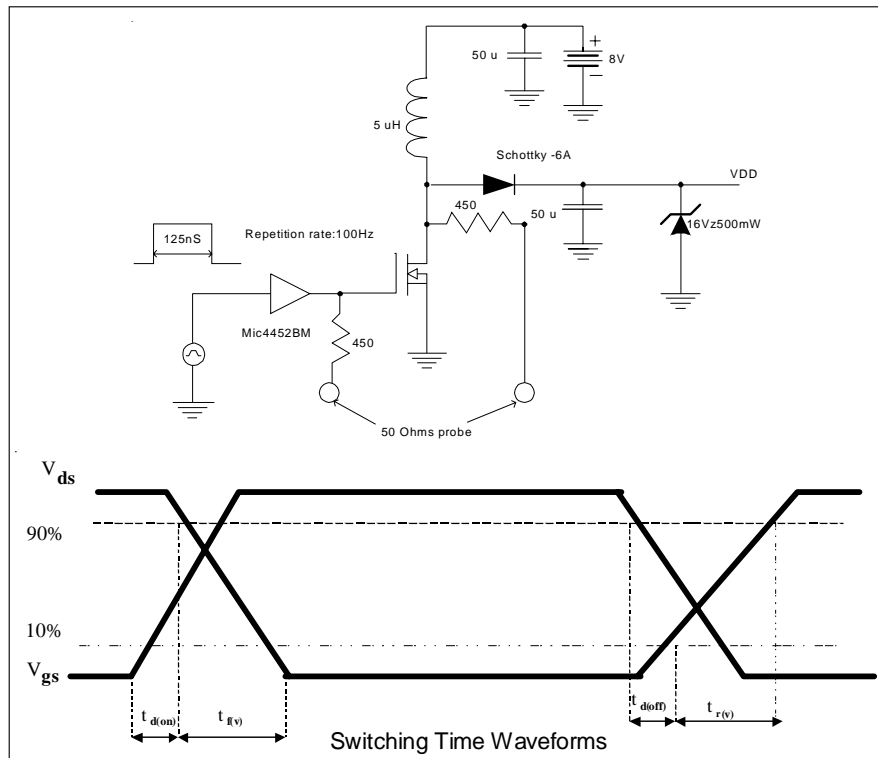
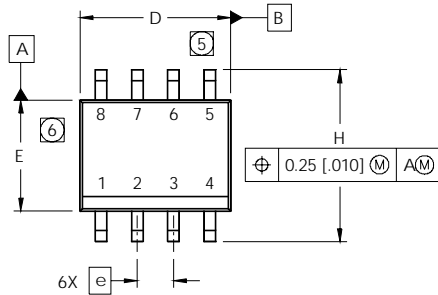

Figure 8. Clamped Inductive load test diagram and switching waveform

SO-8 Package Outline

Dimensions are shown in millimeters (inches)



DIM	INCHES		MILLIMETERS	
	MIN	MAX	MIN	MAX
A	.0532	.0688	1.35	1.75
A1	.0040	.0098	0.10	0.25
b	.013	.020	0.33	0.51
c	.0075	.0098	0.19	0.25
D	.189	.1968	4.80	5.00
E	.1497	.1574	3.80	4.00
e	.050 BASIC		1.27 BASIC	
e1	.025 BASIC		0.635 BASIC	
H	.2284	.2440	5.80	6.20
K	.0099	.0196	0.25	0.50
L	.016	.050	0.40	1.27
y	0°	8°	0°	8°

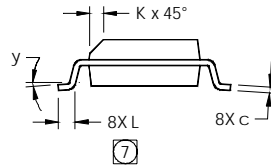
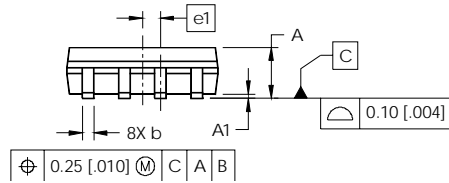

NOTES:

- DIMENSIONING & TOLERANCING PER ASME Y14.5M-1994.
- CONTROLLING DIMENSION: MILLIMETER
- DIMENSIONS ARE SHOWN IN MILLIMETERS [INCHES].
- OUTLINE CONFORMS TO JEDEC OUTLINE MS-012AA
- (5) DIMENSION DOES NOT INCLUDE MOLD PROTRUSIONS. MOLD PROTRUSIONS NOT TO EXCEED 0.15 [0.006].
- (6) DIMENSION DOES NOT INCLUDE MOLD PROTRUSIONS. MOLD PROTRUSIONS NOT TO EXCEED 0.25 [0.010].
- (7) DIMENSION IS THE LENGTH OF LEAD FOR SOLDERING TO A SUBSTRATE.

FOOTPRINT

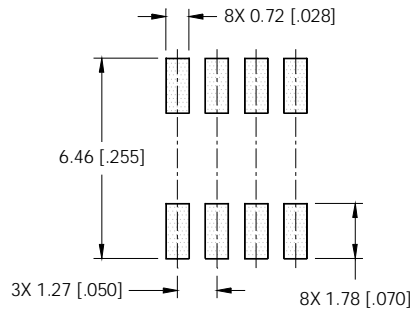

SO-8 Part Marking

EXAMPLE: THIS IS AN IRF7101 (MOSFET)

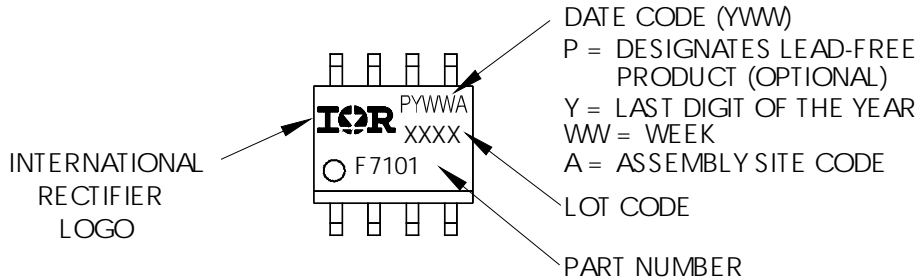

IRF7811AV

International
IR Rectifier

SO-8 Tape and Reel

Dimensions are shown in millimeters (inches)

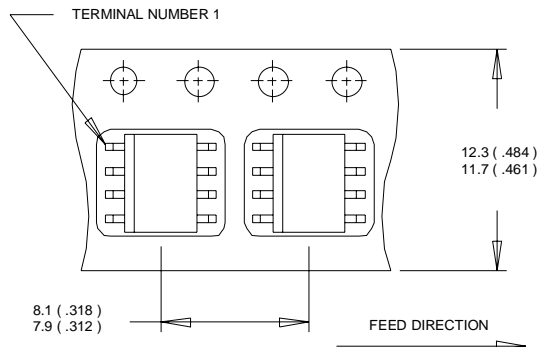

NOTES:

1. CONTROLLING DIMENSION : MILLIMETER.
2. ALL DIMENSIONS ARE SHOWN IN MILLIMETERS(INCHES).
3. OUTLINE CONFORMS TO EIA-481 & EIA-541.

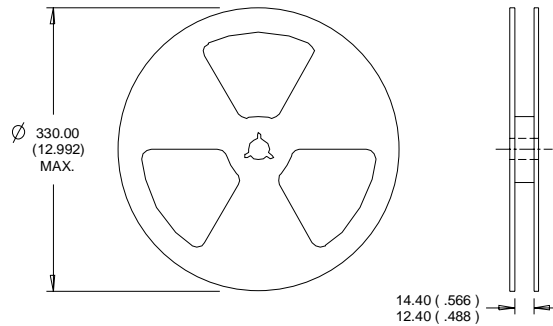

NOTES :

1. CONTROLLING DIMENSION : MILLIMETER.
2. OUTLINE CONFORMS TO EIA-481 & EIA-541.

Data and specifications subject to change without notice.
This product has been designed and qualified for the industrial market.
Qualification Standards can be found on IR's Web site.

International
IR Rectifier

IR WORLD HEADQUARTERS: 233 Kansas St., El Segundo, California 90245, USA Tel: (310) 252-7105
TAC Fax: (310) 252-7903

Visit us at www.irf.com for sales contact information.11/05

www.irf.com