

Aluminum Capacitors Radial, Standard Long-Life

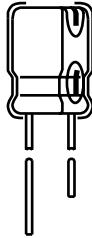
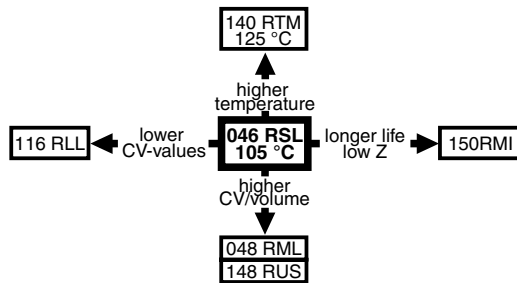

Fig.1 Component outline



FEATURES

- Polarized aluminum electrolytic capacitors, non-solid electrolyte
- Radial leads, cylindrical aluminum case with pressure relief, insulated with a blue vinyl sleeve
- Charge and discharge proof
- Very long useful life: 3000 to 4000 hours at 105 °C, high reliability.
- High ripple current capability, low impedance, low ESR
- Lead (Pb)-free versions are RoHS compliant

**RoHS
COMPLIANT**

APPLICATIONS

- Power conversion, EDP, telecommunication, industrial and audio-video
- Smoothing, filtering, buffering in SMPS, timing

MARKING

The capacitors are marked (where possible) with the following information:

- Rated capacitance (in μF)
- Tolerance on rated capacitance, code letter in accordance with IEC 60062 (M for $\pm 20\%$)
- Rated voltage (in V)
- Date code, in accordance with IEC 60062
- Code indicating factory of origin
- Name of manufacturer
- Upper category temperature (105 °C)
- Negative terminal identification
- Series number (046)

QUICK REFERENCE DATA	
DESCRIPTION	VALUE
Nominal case sizes (\varnothing D x L in mm)	10 x 12 to 18 x 35
Rated capacitance range, C_R	22 to 10 000 μF
Tolerance on C_R	$\pm 20\%$
Rated voltage range, U_R	6.3 to 63 V
Category temperature range	- 40 to + 105 °C
Endurance test at 105 °C	2000 hours
Useful life at 105 °C	
Case \varnothing D = 10 and 12.5 mm	3000 hours
Case \varnothing D = 16 and 18 mm	4000 hours
Useful life at 40 °C, $1.6 \times I_R$ applied	
Case \varnothing D = 10 and 12.5 mm	200 000 hours
Case \varnothing D = 16 and 18 mm	260 000 hours
Shelf life at 0 V, 105 °C	1000 hours
Based on sectional specification	IEC 60384-4/EN130300
Climatic category IEC 60068	40/105/56

SELECTION CHART FOR C_R , U_R AND RELEVANT NOMINAL CASE SIZES (\varnothing D x L in mm)								
C_R (μF)	U_R (V)							
	6.3	10	16	25	35	40	50	63
22	-	-	-	-	-	-	-	10 x 12
47	-	-	-	-	-	-	-	10 x 12
100	-	-	-	-	-	10 x 12	10 x 16	10 x 20
220	-	-	10 x 12	-	10 x 16	10 x 20	12.5 x 20	12.5 x 25
330	-	10 x 12	10 x 16	-	10 x 20	12.5 x 20	12.5 x 25	16 x 25
470	10 x 12	10 x 16	10 x 20	-	12.5 x 20	12.5 x 25	-	16 x 25
1000	10 x 20	12.5 x 20	12.5 x 25	12.5 x 25	16 x 25	-	16 x 31	18 x 35
2200	12.5 x 25	-	16 x 25	16 x 31	16 x 35	18 x 35	18 x 35	-
3300	16 x 25	-	16 x 31	18 x 35	-	18 x 35	-	-
4700	16 x 31	16 x 35	18 x 35	18 x 35	-	-	-	-
6800	16 x 35	18 x 35	18 x 35	-	-	-	-	-
10 000	18 x 35	18 x 35	-	-	-	-	-	-

DIMENSIONS in millimeters, **AND AVAILABLE FORMS**

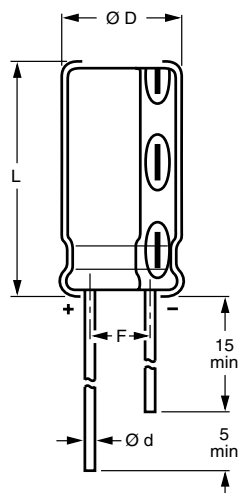

Fig.2 Form CA: Long leads

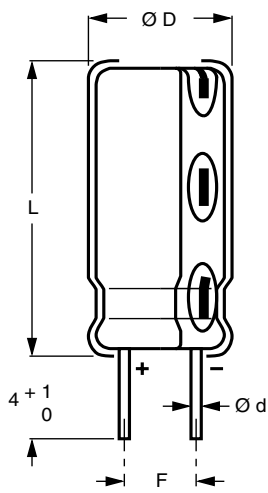
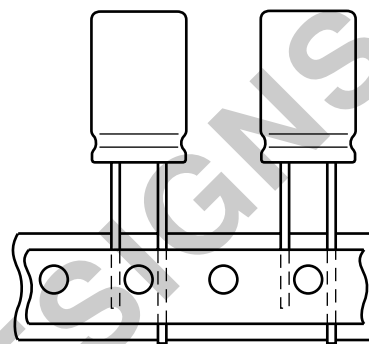

Fig.3 Form CB: Cut leads



Case $\varnothing D \times L \leq 16 \times 31$ mm

Fig.4 Form TFA: Taped in box (ammopack)

Table 1

DIMENSIONS in millimeters, **MASS AND PACKAGING QUANTITIES**

NOMINAL CASE SIZE $\varnothing D \times L$	CASE CODE	$\varnothing d$	$\varnothing D_{max.}$	$L_{max.}$	F	MASS (g)	PACKAGING QUANTITIES		
							FORM CA	FORM CB	FORM TFA
10 x 12	14	0.6	10.5	13.5	5.0 ± 0.5	≈ 1.6	1000	500	800
10 x 16	15	0.6	10.5	17.5	5.0 ± 0.5	≈ 1.9	500	500	800
10 x 20	16	0.6	10.5	22.0	5.0 ± 0.5	≈ 2.2	500	500	800
12.5 x 20	17	0.6	13.0	22.0	5.0 ± 0.5	≈ 4.0	500	500	500
12.5 x 25	18	0.6	13.0	27.0	5.0 ± 0.5	≈ 5.0	250	250	500
16 x 25	19	0.8	16.5	27.0	7.5 ± 0.5	≈ 8.0	250	250	250
16 x 31	20	0.8	16.5	33.5	7.5 ± 0.5	≈ 9.0	100	100	250
16 x 35	21	0.8	16.5	37.5	7.5 ± 0.5	≈ 11.5	100	100	-
18 x 35	22	0.8	18.5	37.5	7.5 ± 0.5	≈ 14.5	300	1000	-

Note

1. Detailed tape dimensions see section 'PACKAGING'.



Aluminum Capacitors
Radial, Standard Long-Life

Vishay BCcomponents

ELECTRICAL DATA	
SYMBOL	DESCRIPTION
C_R	rated capacitance at 100 Hz, tolerance $\pm 20\%$
I_R	rated RMS ripple current at 100 Hz, 105 °C
I_{RH}	rated RMS ripple current at 100 kHz, 105 °C
I_{L1}	max. leakage current after 1 minute at U_R
I_{L5}	max. leakage current after 5 minutes at U_R
$\tan \delta$	max. dissipation factor at 100 Hz
ESR	equivalent series resistance at 100 Hz (calculated from $\tan \delta_{max}$ and C_R)
Z	max. impedance at 10 kHz or 100 kHz

ORDERING EXAMPLE

Electrolytic capacitor 046 series

2200 μ F/16 V; $\pm 20\%$

Nominal case size: $\varnothing 16 \times 25$ mm; Form TFA

Ordering code: MAL204635222E3

Former 12NC: 2222 046 35222

Note

Unless otherwise specified, all electrical values in Table 2 apply at $T_{amb} = 20$ °C, P = 86 to 106 kPa, RH = 45 to 75 %.

Table 2

ELECTRICAL DATA AND ORDERING INFORMATION														
U_R (V)	C_R 100 Hz (μ F)	NOMINAL CASE SIZE $\varnothing D \times L$ (mm)	CASE CODE	I_R 100 Hz 105 °C (mA)	I_{RH} 100 kHz 105 °C (mA)	I_{L1} 1 min (μ A)	I_{L5} 5 min (μ A)	$\tan \delta$ 100 Hz	ESR 100 Hz (Ω)	Z 10 kHz (Ω)	Z 100 kHz (Ω)	ORDERING NUMBER MAL2046.....		
												BULK PACKAGING		TAPED
												FORM CA	FORM CB	FORM TFA
6.3	470	10 x 12	14	360	600	33	9	0.19	0.64	0.32	0.28	53471E3	63471E3	33471E3
	1000	10 x 20	16	600	1000	66	16	0.19	0.30	0.15	0.14	53102E3	63102E3	33102E3
	2200	12.5 x 25	18	950	1500	140	31	0.23	0.17	0.08	0.07	53222E3	63222E3	33222E3
	3300	16 x 25	19	1200	1700	210	45	0.25	0.12	0.06	0.06	53332E3	63332E3	33332E3
	4700	16 x 31	20	1400	2000	300	62	0.27	0.09	0.05	0.05	53472E3	63472E3	33472E3
	6800	16 x 35	21	1600	2100	430	89	0.31	0.07	0.05	0.05	53682E3	63682E3	-
	1000	18 x 35	22	1800	2300	630	130	0.39	0.06	0.04	0.04	53103E3	63103E3	-
10	330	10 x 12	14	370	620	36	10	0.15	0.72	0.38	0.31	54331E3	64331E3	34331E3
	470	10 x 16	15	460	800	50	12	0.15	0.51	0.27	0.22	54471E3	64471E3	34471E3
	1000	12.5 x 20	17	770	1100	100	23	0.15	0.24	0.13	0.12	54102E3	64102E3	34102E3
	4700	16 x 35	21	1600	2300	470	97	0.23	0.08	0.04	0.04	54472E3	64472E3	-
	6800	18 x 35	22	1800	2500	680	140	0.27	0.06	0.03	0.03	54682E3	64682E3	-
	10000	18 x 35	22	2000	2600	1000	200	0.35	0.06	0.03	0.03	54103E3	64103E3	-
16	220	10 x 12	14	350	620	38	10	0.13	0.94	0.40	0.31	55221E3	65221E3	35221E3
	330	10 x 16	15	430	800	56	14	0.13	0.63	0.30	0.22	55331E3	65331E3	35331E3
	470	10 x 20	16	560	920	78	18	0.13	0.44	0.21	0.18	55471E3	65471E3	35471E3
	1000	12.5 x 20	18	900	1500	160	35	0.13	0.21	0.10	0.10	55102E3	65102E3	35102E3
	2200	16 x 25	19	1300	1800	360	73	0.17	0.12	0.06	0.05	55222E3	65222E3	35222E3
	3300	16 x 31	20	1600	2200	530	110	0.19	0.09	0.04	0.04	55332E3	65332E3	35332E3
	4700	18 x 35	22	1800	2500	760	150	0.21	0.07	0.03	0.03	55472E3	65472E3	-
6800	18 x 35	22	2000	2600	1100	220	0.25	0.06	0.03	0.03	55682E3	65682E3	-	
25	1000	12.5 x 25	18	900	1500	250	53	0.11	0.18	0.09	0.08	56102E3	66102E3	36102E3
	2200	16 x 31	20	1600	2100	550	110	0.15	0.11	0.04	0.04	56222E3	66222E3	36222E3
	3300	18 x 35	22	1900	2500	830	170	0.17	0.08	0.03	0.03	56332E3	66332E3	-
	4700	18 x 35	22	2000	2600	1200	240	0.19	0.06	0.03	0.03	56472E3	66472E3	-
35	220	18 x 35	15	400	740	80	18	0.10	0.72	0.30	0.23	50221E3	60221E3	30221E3
	330	18 x 35	16	510	880	120	26	0.10	0.48	0.26	0.16	50331E3	60331E3	30331E3
	470	18 x 35	17	650	1000	170	36	0.10	0.34	0.14	0.11	50471E3	60471E3	30471E3
	1000	18 x 35	19	1200	1600	350	73	0.10	0.16	0.07	0.06	50102E3	60102E3	30102E3
	2200	16 x 35	21	1800	2000	770	160	0.12	0.10	0.04	0.04	50222E3	60222E3	-



ELECTRICAL DATA AND ORDERING INFORMATION														
U _R (V)	C _R 100 Hz (µF)	NOMINAL CASE SIZE Ø D x L (mm)	CASE CODE	I _R 100 Hz 105 °C (mA)	I _{RH} 100 kHz 105 °C (mA)	I _{L1} 1 min (µA)	I _{L5} 5 min (µA)	tan δ 100 Hz	ESR 100 Hz (Ω)	Z 10 kHz (Ω)	Z 100 kHz (Ω)	ORDERING NUMBER MAL2046.....		
												BULK PACKAGING		TAPED
												FORM CA	FORM CB	FORM TFA
40	100	10 x 12	14	300	560	43	11	0.09	1.43	0.60	0.35	57101E3	67101E3	-
	220	10 x 20	16	450	850	91	21	0.09	0.65	0.27	0.17	57221E3	67221E3	37221E3
	330	12.5 x 20	17	590	1000	140	29	0.09	0.43	0.18	0.13	57331E3	67331E3	37331E3
	470	12.5 x 25	18	750	1300	190	41	0.09	0.30	0.13	0.08	57471E3	67471E3	37471E3
	2200	18 x 35	22	1900	2500	880	180	0.11	0.08	0.03	0.03	57222E3	67222E3	-
	3300	18 x 35	22	2100	2600	1300	270	0.12	0.06	0.03	0.03	57332E3	67332E3	-
50	100	10 x 16	15	310	610	53	13	0.07	1.11	0.50	0.28	51101E3	61101E3	31101E3
	220	12.5 x 20	17	500	980	110	25	0.07	0.51	0.23	0.13	51221E3	61221E3	31221E3
	330	12.5 x 25	18	680	1200	170	36	0.07	0.34	0.15	0.09	51331E3	61331E3	31331E3
	1000	16 x 31	20	1400	1800	500	100	0.07	0.11	0.05	0.05	51102E3	61102E3	31102E3
	2200	18 x 35	22	2000	2600	1100	220	0.09	0.07	0.03	0.03	51222E3	61222E3	-
63	22	10 x 12	14	170	310	17	9	0.06	4.3	1.6	0.7	58229E3	68229E3	38229E3
	47	10 x 12	14	230	430	33	9	0.06	2.03	0.96	0.40	58479E3	68479E3	38479E3
	100	10 x 20	16	360	710	66	16	0.06	0.95	0.45	0.20	58101E3	68101E3	38101E3
	220	12.5 x 25	18	610	1100	140	31	0.06	0.43	0.20	0.11	58221E3	68221E3	38221E3
	330	16 x 25	19	750	1300	210	45	0.06	0.29	0.14	0.08	58331E3	68331E3	38331E3
	470	16 x 25	19	950	1600	300	62	0.06	0.20	0.10	0.06	58471E3	68471E3	38471E3
	1000	16 x 35	22	1500	2100	630	130	0.06	0.10	0.04	0.04	58102E3	68102E3	-

ADDITIONAL ELECTRICAL DATA		
PARAMETER	CONDITIONS	VALUE
Voltage		
Surge voltage		U _s ≤ 1.15 U _R
Reverse voltage		U _{rev} ≤ 1 V
Current		
Leakage current	After 1 minute at U _R	I _{L1} ≤ 0.01 C _R x U _R + 3 µA
	After 5 minutes at U _R	I _{L5} ≤ 0.002 C _R x U _R + 3 µA
Inductance		
Equivalent series inductance (ESL)	Case Ø D = 10 mm	typ. 16 nH
	Case Ø D ≥ 12.5 mm	typ. 18 nH

CAPACITANCE (C)

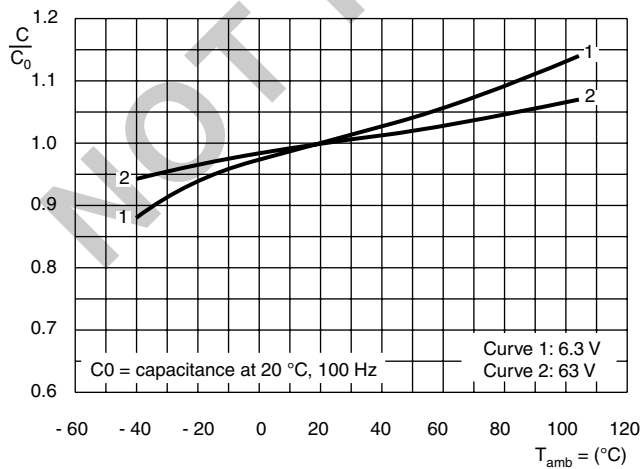

Fig.5 Typical multiplier of capacitance as a function of ambient temperature.

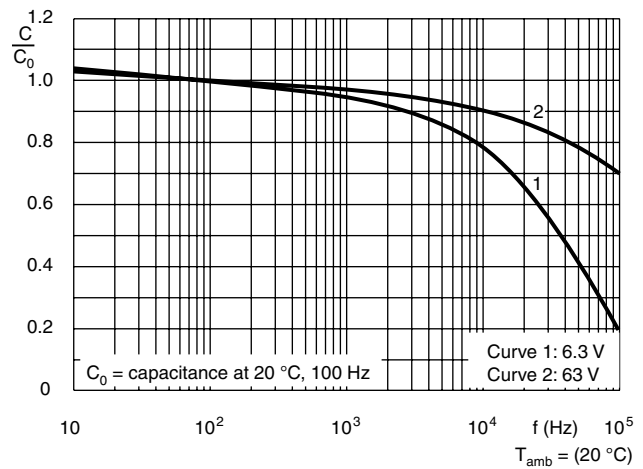

Fig.6 Typical multiplier of capacitance as a function of frequency.

EQUIVALENT SERIES RESISTANCE (ESR)

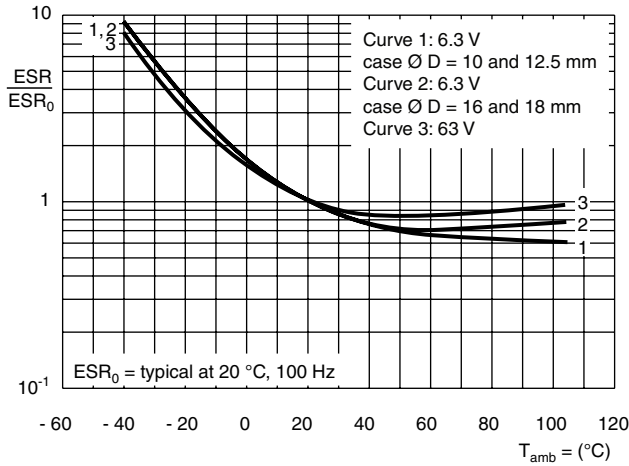

Fig.7 Typical multiplier of ESR as a function of ambient temperature.

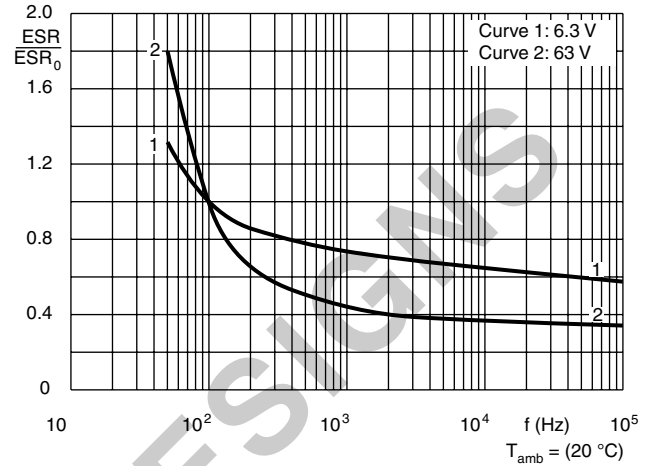

Fig.8 Typical multiplier of ESR as a function of frequency.

IMPEDANCE (Z)

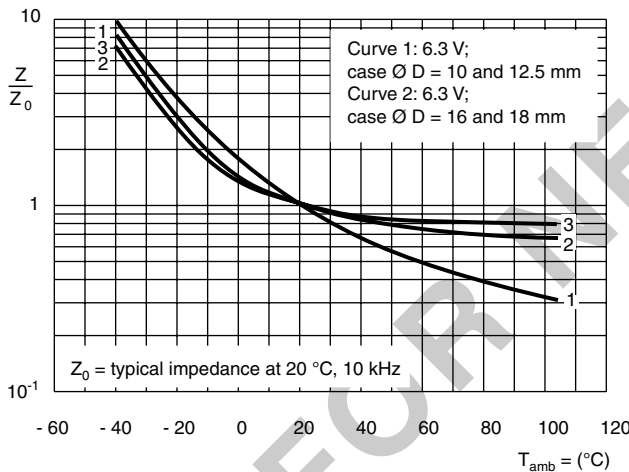

Fig.9 Typical multiplier of Impedance as a function of ambient temperature.

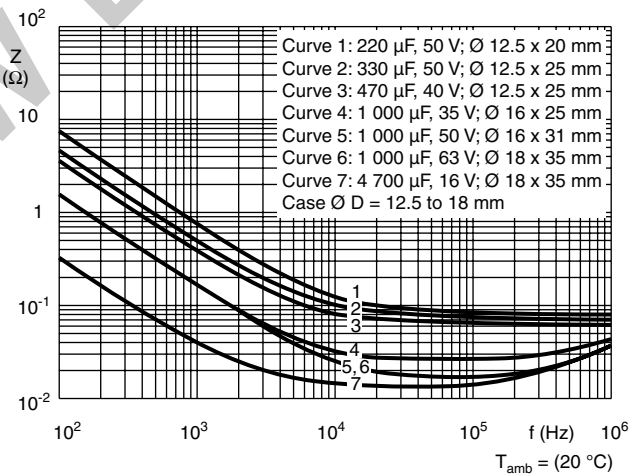

Fig.10 Typical impedance as a function of frequency.

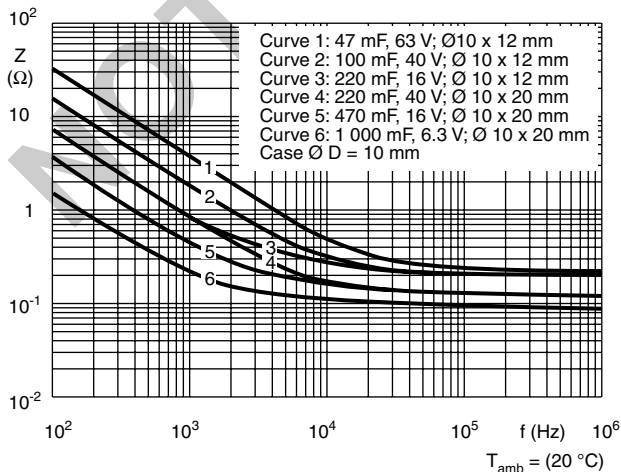
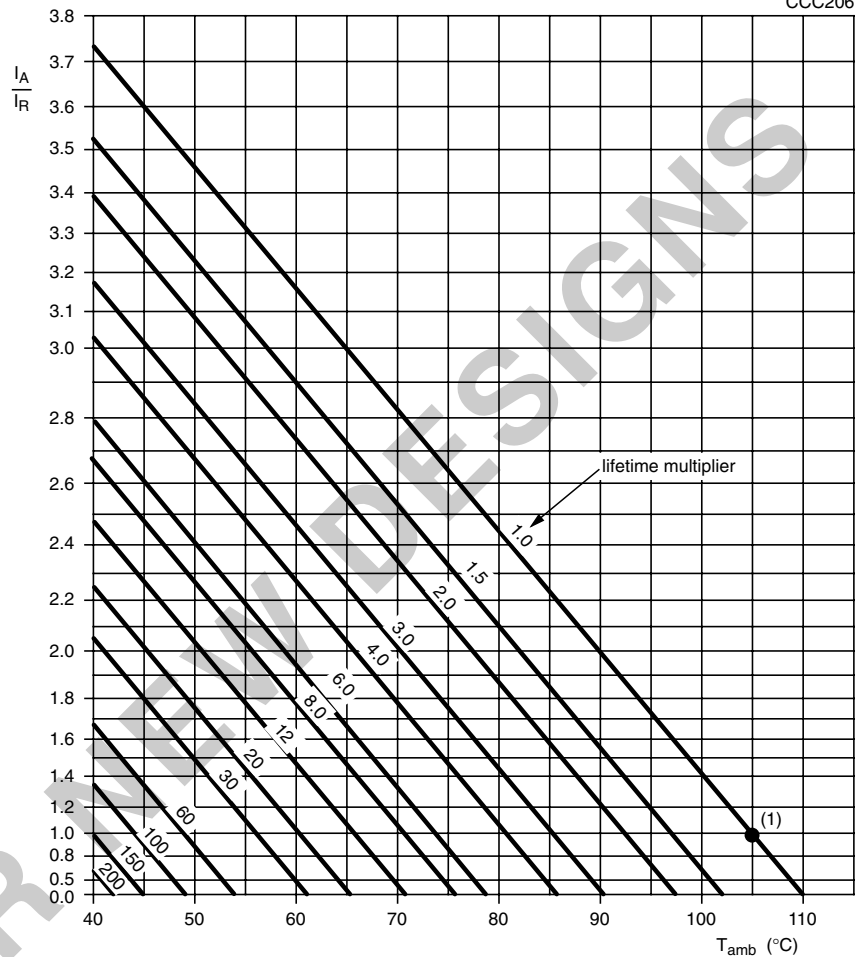

Fig.9 Typical impedance as a function of frequency.

RIPPLE CURRENT AND USEFUL LIFE

CCC206



I_A = actual ripple current at 100 Hz or 100 kHz.
 I_R = rated ripple current at 100 Hz or 100 kHz, 105 °C

(1) Useful life at 105 °C and I_R applied:
 case $\varnothing D = 10$ and 12.5 mm; 3000 hours
 case $\varnothing D = 16$ and 18 mm; 4000 hours

Fig.12 Multiplier of useful life as a function of ambient temperature and ripple current load.

Table 3

TEST PROCEDURES AND REQUIREMENTS			
TEST		PROCEDURE (quick reference)	REQUIREMENTS
Name of test	Reference		
Endurance	IEC 60384-4/ EN130300 subclause 4.13	$T_{amb} = 105\text{ °C}$; U_R applied; 2000 hours	$U_R = 6.3\text{ V}$; $\Delta C/C$: + 15/- 30 % $U_R > 6.3\text{ V}$; $\Delta C/C$: $\pm 15\%$ $\tan \delta \leq 1.3 \times \text{spec. limit}$ $Z \leq 2 \times \text{spec. limit}$ $I_{L5} \leq \text{spec. limit}$
Useful life	CECC 30301 subclause 1.8.1	$T_{amb} = 105\text{ °C}$; U_R and I_R applied; 3000 hours, case $\varnothing D = 10$ and 12.5 mm; 4000 hours, case $\varnothing D = 16$ and 18 mm	$U_R = 6.3\text{ V}$; $\Delta C/C$: + 45/- 50 % $U_R > 6.3\text{ V}$; $\Delta C/C$: $\pm 45\%$ $\tan \delta \leq 3 \times \text{spec. limit}$ $Z \leq 3 \times \text{spec. limit}$ $I_{L5} \leq \text{spec. limit}$ no short or open circuit total failure percentage: $\leq 1\%$
Shelf life (storage at high temperature)	IEC 60384-4/ EN130300 subclause 4.17	$T_{amb} = 105\text{ °C}$; no voltage applied; 1000 hours after test: U_R to be applied for 30 minutes, 24 to 48 hours before measurement	$U_R = 6.3\text{ V}$; $\Delta C/C$: + 15/- 30 % $U_R > 6.3\text{ V}$; $\Delta C/C$: $\pm 15\%$ $\tan \delta \leq 1.3 \times \text{spec. limit}$ $Z \leq 2 \times \text{spec. limit}$ $I_{L5} \leq 2 \times \text{spec. limit}$



Disclaimer

All product specifications and data are subject to change without notice.

Vishay Intertechnology, Inc., its affiliates, agents, and employees, and all persons acting on its or their behalf (collectively, "Vishay"), disclaim any and all liability for any errors, inaccuracies or incompleteness contained herein or in any other disclosure relating to any product.

Vishay disclaims any and all liability arising out of the use or application of any product described herein or of any information provided herein to the maximum extent permitted by law. The product specifications do not expand or otherwise modify Vishay's terms and conditions of purchase, including but not limited to the warranty expressed therein, which apply to these products.

No license, express or implied, by estoppel or otherwise, to any intellectual property rights is granted by this document or by any conduct of Vishay.

The products shown herein are not designed for use in medical, life-saving, or life-sustaining applications unless otherwise expressly indicated. Customers using or selling Vishay products not expressly indicated for use in such applications do so entirely at their own risk and agree to fully indemnify Vishay for any damages arising or resulting from such use or sale. Please contact authorized Vishay personnel to obtain written terms and conditions regarding products designed for such applications.

Product names and markings noted herein may be trademarks of their respective owners.