

December 22, 1997

TEL:805-498-2111 FAX:805-498-3804 WEB: <http://www.semtech.com>

HIGH CURRENT, HIGH DENSITY, ISOLATED, SILICON POWER RECTIFIERS

- Low thermal impedance
- Small size and low weight
- High current applications
- Isolated for direct heatsink mounting
- High surge ratings

QUICK REFERENCE DATA

- $V_R = 150V - 1000V$
- $I_F = 15A$
- $t_{rr} = 10nS - 2\mu S$
- $I_{FSM} \geq 150A$

ABSOLUTE MAXIMUM RATINGS

Device Type	Working Reverse Voltage (V_{RWM})	Average Rectified Current ($I_{F(AV)}$) @ T_{mb}			1 Cycle Surge I_{FSM} $t_P = 8.3mS$		Repetitive Surge (I_{FRM})	Operating & Storage Temperature Range	
		@ 55°C	100°C	125°C	@ 25 °C	@ 100°C	@ 25 °C	(T_{OP})	(T_{STG})
		Volts	Amps	Amps	Amps	Amps	Amps	Amps	°C
ISOPAC0103	1000	15	11	8	150	100	25	-55 to +175	
ISOPAC0119	1000	10	8	6	150	80	15	-55 to +175	
ISOPAC0112	600	15	11	8	150	100	25	-55 to +175	
ISOPAC0104	400	15	11	8	150	80	25	-55 to +175	
ISOPAC0111	150	15	10	7	175	175	24	-55 to +150	
ISOPAC0203	1000	15	11	8	150	100	25	-55 to +175	
ISOPAC0219	1000	10	8	6	150	80	15	-55 to +175	
ISOPAC0212	600	15	11	8	150	100	25	-55 to +175	
ISOPAC0204	400	15	11	8	150	80	25	-55 to +175	
ISOPAC0211	150	15	10	7	175	175	24	-55 to +150	
ISOPAC0403	1000	15	11	8	150	100	25	-55 to +175	
ISOPAC0419	1000	10	8	6	150	80	15	-55 to +175	
ISOPAC0412	600	15	11	8	150	100	25	-55 to +175	
ISOPAC0404	400	15	11	8	150	80	25	-55 to +175	
ISOPAC0411	150	15	10	7	175	175	24	-55 to +150	
ISOPAC0603	1000	15	11	8	150	100	25	-55 to +175	
ISOPAC0619	1000	10	8	6	150	80	15	-55 to +175	
ISOPAC0612	600	15	11	8	150	100	25	-55 to +175	
ISOPAC0604	400	15	11	8	150	80	25	-55 to +175	
ISOPAC0611	150	15	10	7	175	175	24	-55 to +150	
ISOPAC1203	1000	15	11	8	150	100	25	-55 to +175	
ISOPAC1219	1000	10	8	6	150	80	15	-55 to +175	
ISOPAC1212	600	15	11	8	150	100	25	-55 to +175	
ISOPAC1204	400	15	11	8	150	80	25	-55 to +175	
ISOPAC1211	150	15	10	7	175	175	24	-55 to +150	

December 22, 1997

ELECTRICAL CHARACTERISTICS (apply per junction)

Device Type	Maximum Leakage Current @ V_{RWM}		Maximum Forward Voltage @ 9.0 A	Maximum Reverse Recovery Time
	$T_j = 25^\circ\text{C}$	$T_j = 100^\circ\text{C}$		
	μA	μA	Volts	nS
ISOPAC0103	1.0	20	1.2	2000
ISOPAC0119	1.0	25	2.2	150
ISOPAC0112	1.0	20	1.2	2000
ISOPAC0104	1.0	20	1.5	150
ISOPAC0111	10.0	500	1.1	30
ISOPAC0203	1.0	20	1.2	2000
ISOPAC0219	1.0	25	2.2	150
ISOPAC0212	1.0	20	1.2	2000
ISOPAC0204	1.0	20	1.5	150
ISOPAC0211	10.0	500	1.1	30
ISOPAC0403	1.0	20	1.2	2000
ISOPAC0419	1.0	25	2.2	150
ISOPAC0412	1.0	20	1.2	2000
ISOPAC0404	1.0	20	1.5	150
ISOPAC0411	10.0	500	1.1	30
ISOPAC0603	1.0	20	1.2	2000
ISOPAC0619	1.0	25	2.2	150
ISOPAC0612	1.0	20	1.2	2000
ISOPAC0604	1.0	20	1.5	150
ISOPAC0611	10.0	500	1.1	30
ISOPAC1203	1.0	20	1.2	2000
ISOPAC1219	1.0	25	2.2	150
ISOPAC1212	1.0	20	1.2	2000
ISOPAC1204	1.0	20	1.5	150
ISOPAC1211	10.0	500	1.1	30

$R_{\theta JMB} = 3^\circ\text{C/W}$ per junction.

Non-isolated forms are available, consult factory for details.

December 22, 1997

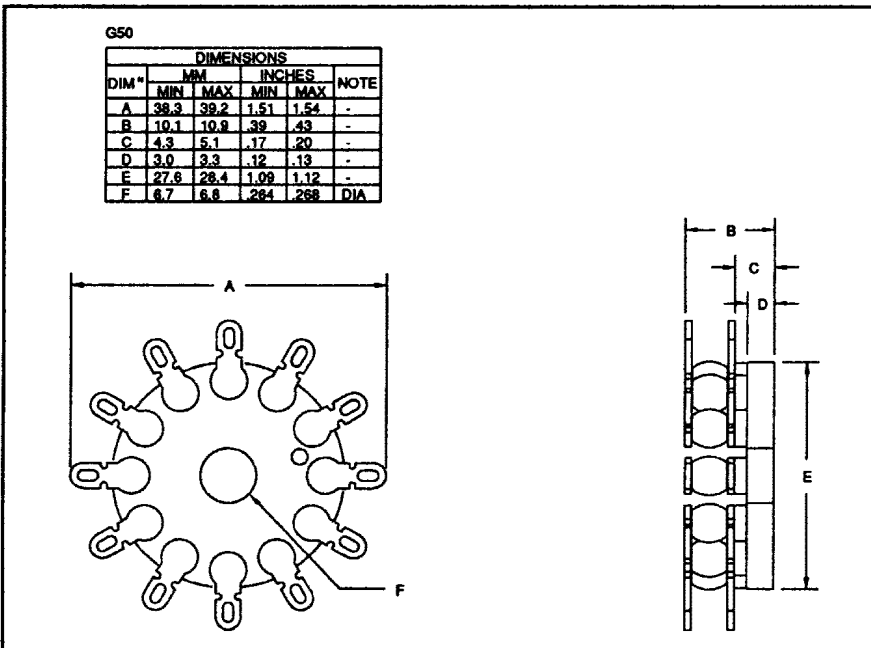
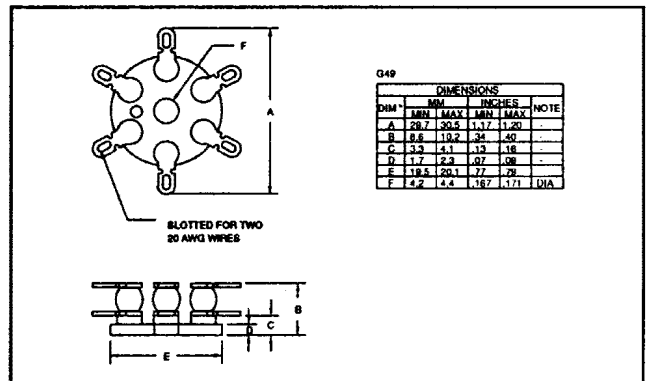
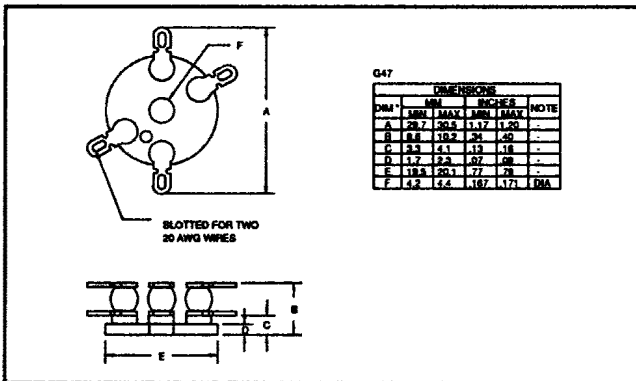
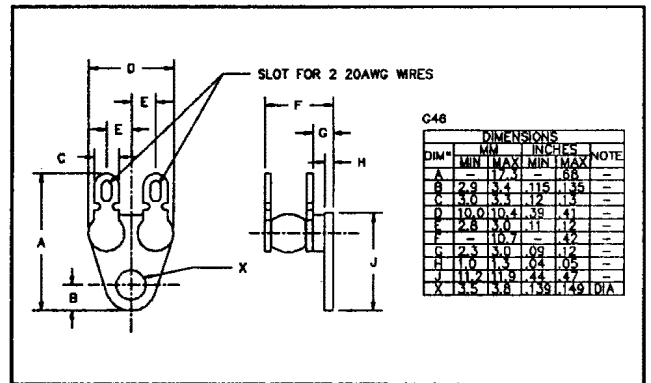
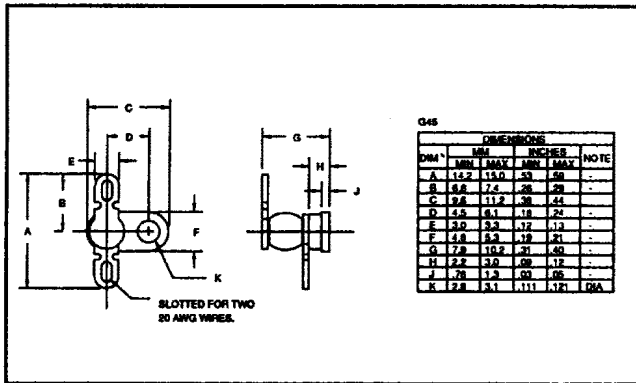

December 22, 1997

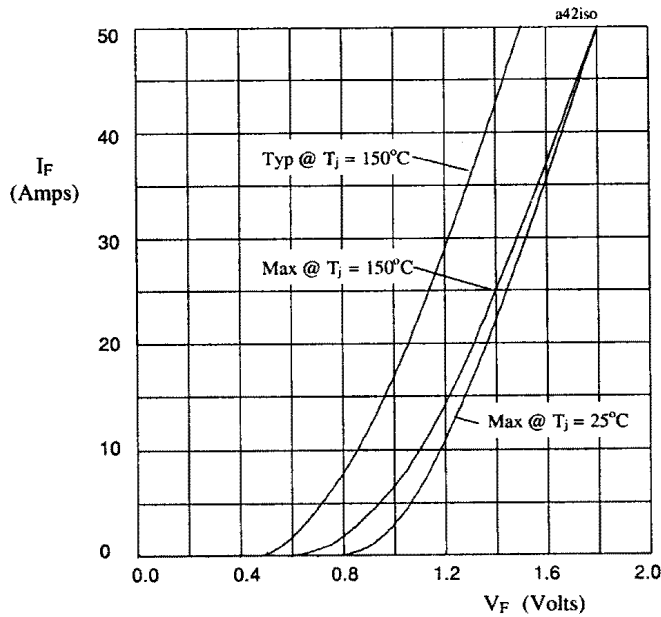

Figure 1. Forward voltage drop as a function of forward current for ISOPAC**03 & ISOPAC**12.

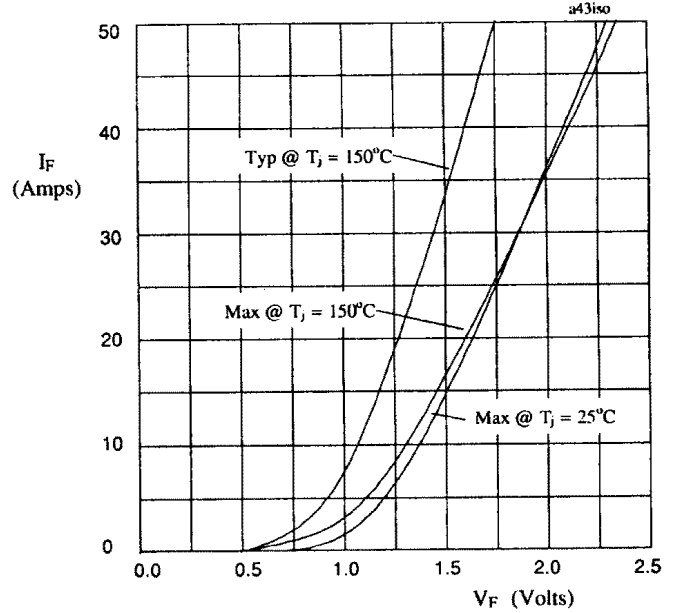

Figure 2. Forward voltage drop as a function of forward current for ISOPAC**04.

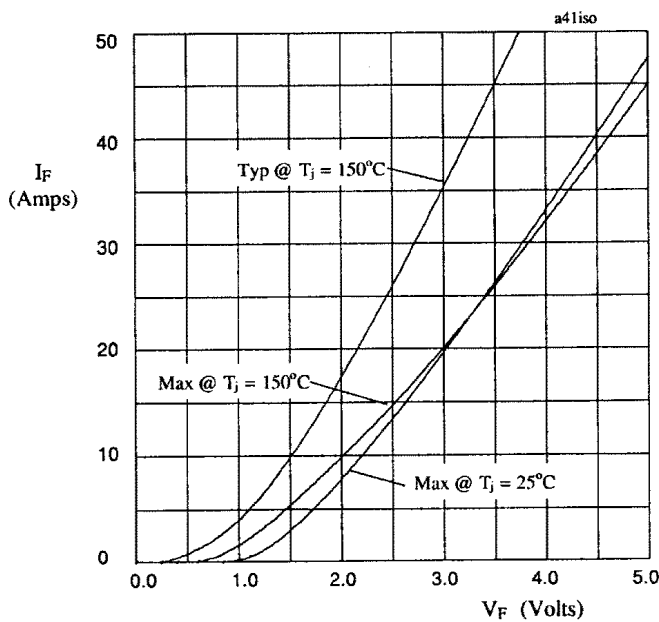

Figure 3. Forward voltage drop as a function of forward current for ISOPAC**19.

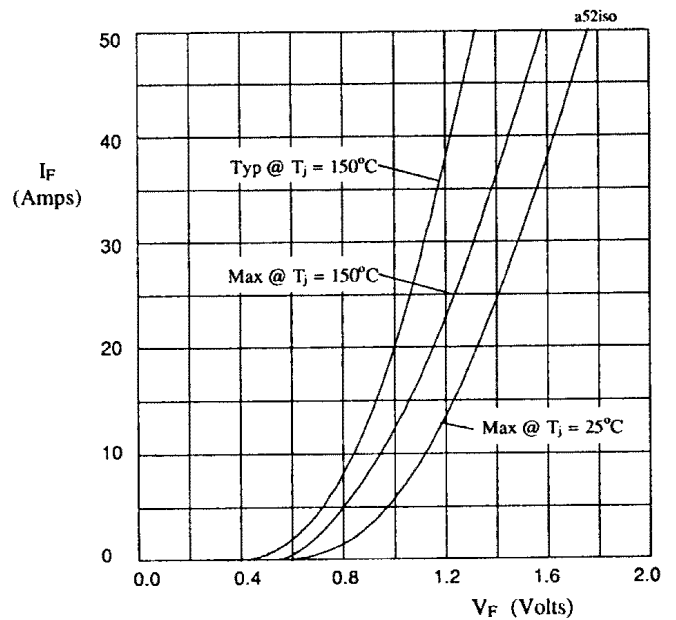

Figure 4. Forward voltage drop as a function of forward current for ISOPAC**11.

December 22, 1997

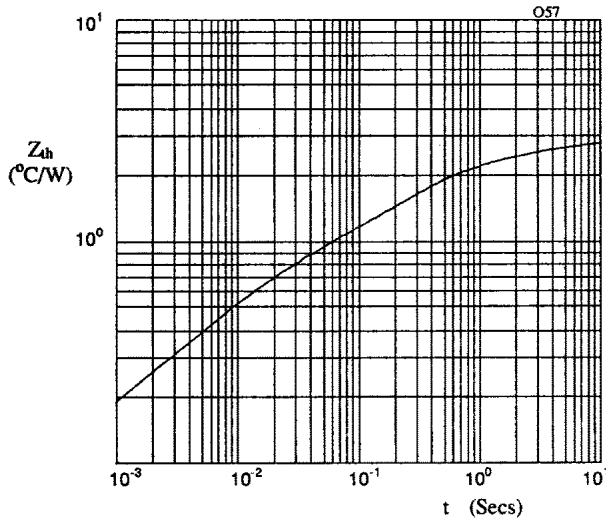

Figure 5. Typical transient thermal impedance characteristic.

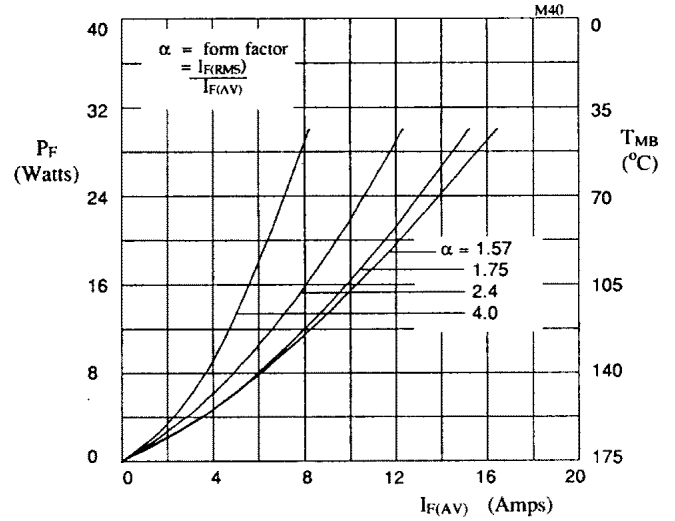

Figure 6. Forward power dissipation and maximum allowable mounting base temperature as a function of forward current for sinusoidal operation, for ISOPAC**03 and ISOPAC**12.

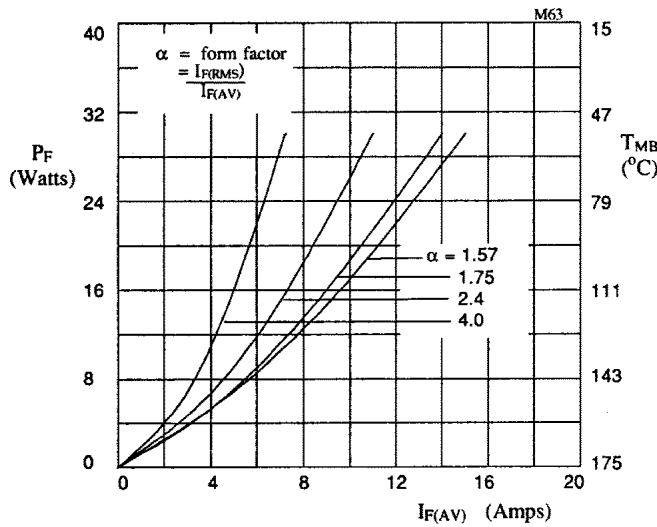

Figure 7. Forward power dissipation and maximum allowable mounting base temperature as a function of forward current for sinusoidal operation, for ISOPAC**04.

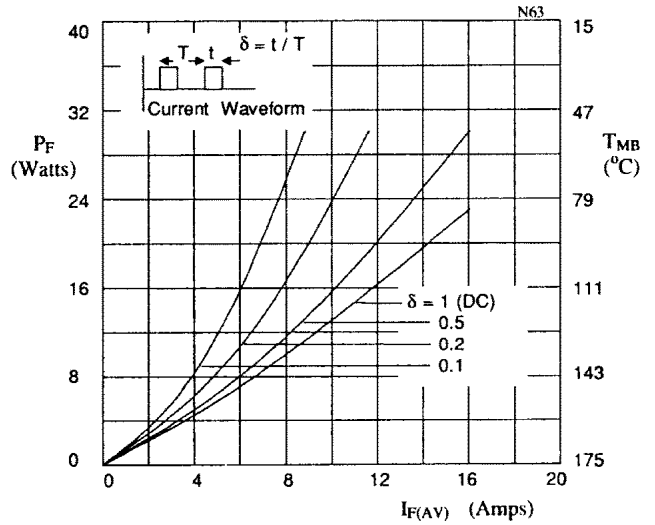

Figure 8. Forward power dissipation and maximum allowable mounting base temperature as a function of forward current for square wave operation, for ISOPAC**04.

December 22, 1997

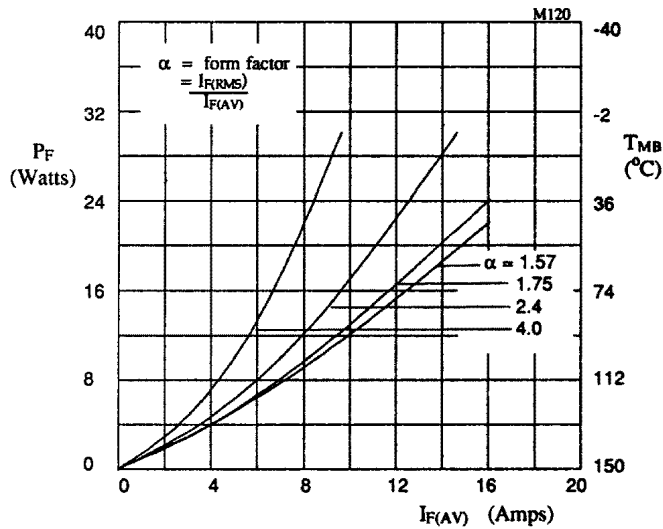

Figure 9. Forward power dissipation and maximum allowable mounting base temperature as a function of forward current for sinusoidal operation, for ISOPAC**11.

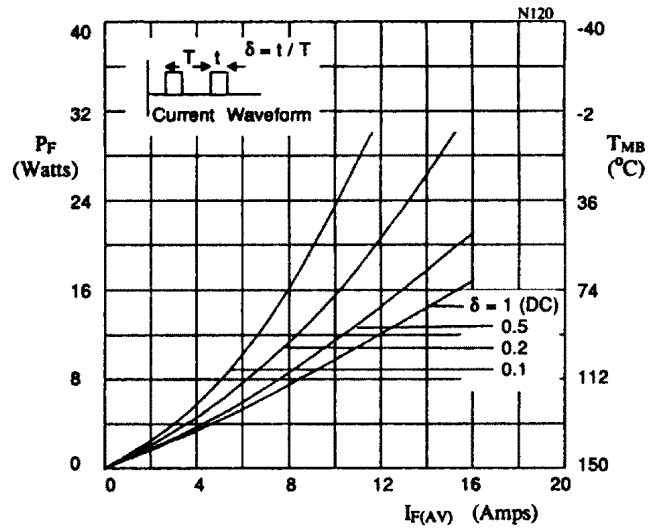

Figure 10. Forward power dissipation and maximum allowable mounting base temperature as a function of forward current for square wave operation, for ISOPAC**11.