

# Dual High-Voltage Trench MOS Barrier Schottky Rectifier

Ultra Low  $V_F = 0.41\text{ V}$  at  $I_F = 5\text{ A}$

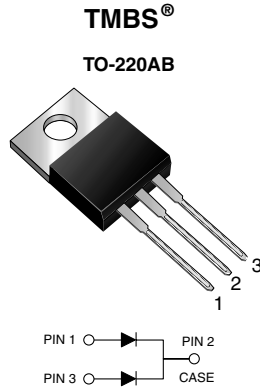

## FEATURES

- Trench MOS Schottky technology
- Low forward voltage drop, low power losses
- High efficiency operation
- Low thermal resistance
- Solder dip 260 °C, 40 s
- Component in accordance to RoHS 2002/95/EC and WEEE 2002/96/EC



## TYPICAL APPLICATIONS

For use in high frequency inverters, switching power supplies, freewheeling diodes, OR-ing diode, dc-to-dc converters and reverse battery protection.

PRIMARY CHARACTERISTICS	
$I_{F(AV)}$	2 x 30 A
$V_{RRM}$	120 V
$I_{FSM}$	300 A
$V_F$ at $I_F = 30\text{ A}$	0.71 V
$T_J$ max.	150 °C

## MECHANICAL DATA

**Case:** TO-220AB

Epoxy meets UL 94V-0 flammability rating

**Terminals:** Matte tin plated leads, solderable per J-STD-002 and JESD22-B102

E3 suffix for consumer grade, meets JESD 201 class 1A whisker test

**Polarity:** As marked

**Mounting Torque:** 10 in-lbs maximum

MAXIMUM RATINGS ( $T_A = 25\text{ °C}$ unless otherwise noted)			
PARAMETER	SYMBOL	V60120C	UNIT
Maximum repetitive peak reverse voltage	$V_{RRM}$	120	V
Maximum average forward rectified current (Fig. 1)	$I_{F(AV)}$	60 30	A
Peak forward surge current 10 ms single half sine-wave superimposed on rated load per diode	$I_{FSM}$	300	
Peak repetitive reverse current per diode at $t_p = 2\text{ }\mu\text{s}$ , 1 kHz	$I_{RRM}$	1.0	
Voltage rate of change (rated $V_R$ )	dV/dt	10 000	V/ $\mu\text{s}$
Operating junction and storage temperature range	$T_J, T_{STG}$	- 40 to + 150	°C

ELECTRICAL CHARACTERISTICS (T <sub>A</sub> = 25 °C unless otherwise noted)						
PARAMETER	TEST CONDITIONS		SYMBOL	TYP.	MAX.	UNIT
Breakdown voltage	I <sub>R</sub> = 1.0 mA	T <sub>A</sub> = 25 °C	V <sub>BR</sub>	120 (minimum)	-	V
Instantaneous forward voltage per diode (1)	I <sub>F</sub> = 5 A	T <sub>A</sub> = 25 °C	V <sub>F</sub>	0.48	-	
	I <sub>F</sub> = 15 A			0.66	-	
	I <sub>F</sub> = 30 A			0.88	0.95	
Reverse current at rated V <sub>R</sub> per diode (2)	V <sub>R</sub> = 90 V	T <sub>A</sub> = 25 °C	I <sub>R</sub>	14	-	μA
		T <sub>A</sub> = 125 °C		11	-	mA
	V <sub>R</sub> = 120 V	T <sub>A</sub> = 25 °C	40	500	μA	
		T <sub>A</sub> = 125 °C		15	45	mA

**Notes:**

- (1) Pulse test: 300 μs pulse width, 1 % duty cycle
- (2) Pulse test: Pulse width ≤ 40 ms

THERMAL CHARACTERISTICS (T <sub>A</sub> = 25 °C unless otherwise noted)			
PARAMETER	SYMBOL	V60120C	UNIT
Typical thermal resistance per diode	R <sub>θJC</sub>	2.2	°C/W

ORDERING INFORMATION (Example)					
PACKAGE	PREFERRED P/N	UNIT WEIGHT (g)	PACKAGE CODE	BASE QUANTITY	DELIVERY MODE
TO-220AB	V60120C-E3/4W	1.89	4W	50/tube	Tube

## RATINGS AND CHARACTERISTICS CURVES

(T<sub>A</sub> = 25 °C unless otherwise noted)

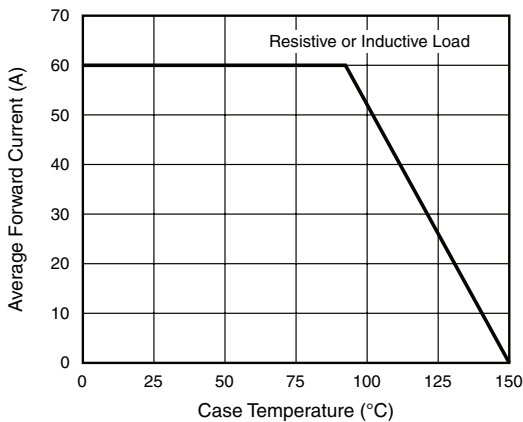

Figure 1. Forward Current Derating Curve

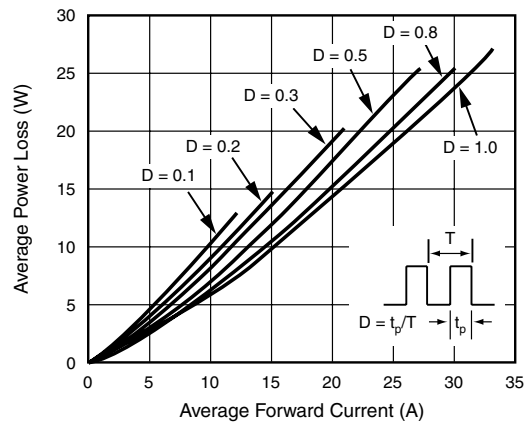

Figure 2. Forward Power Loss Characteristics Per Diode

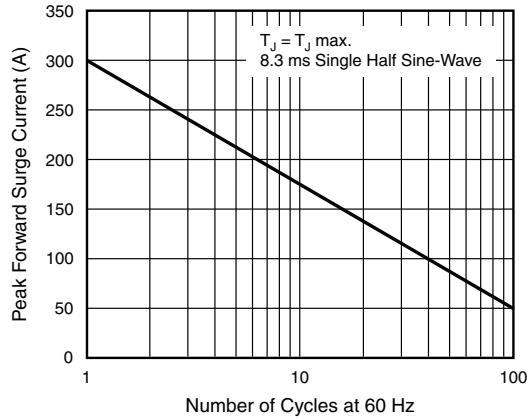

Figure 3. Maximum Non-Repetitive Peak Forward Surge Current Per Diode

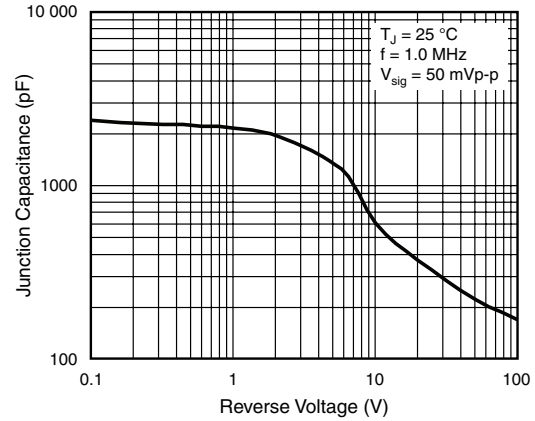

Figure 6. Typical Junction Capacitance Per Diode

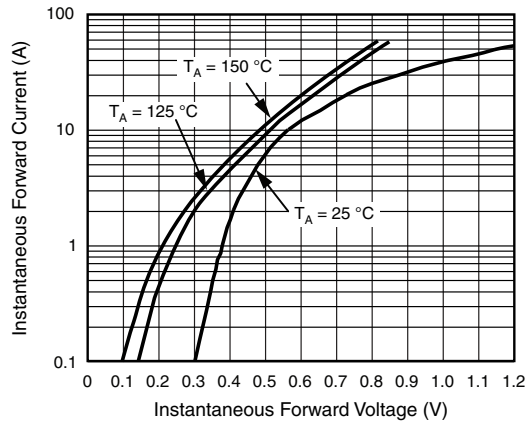

Figure 4. Typical Instantaneous Forward Characteristics Per Diode

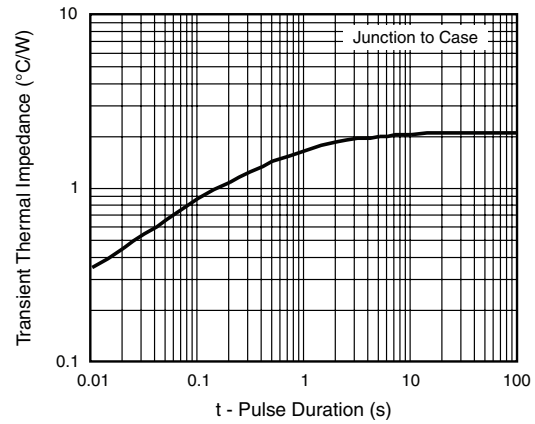

Figure 7. Typical Transient Thermal Impedance Per Diode

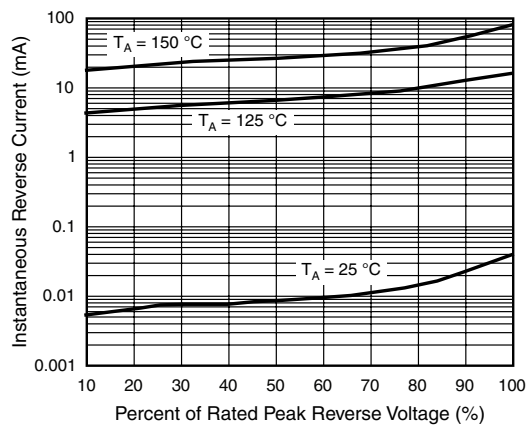
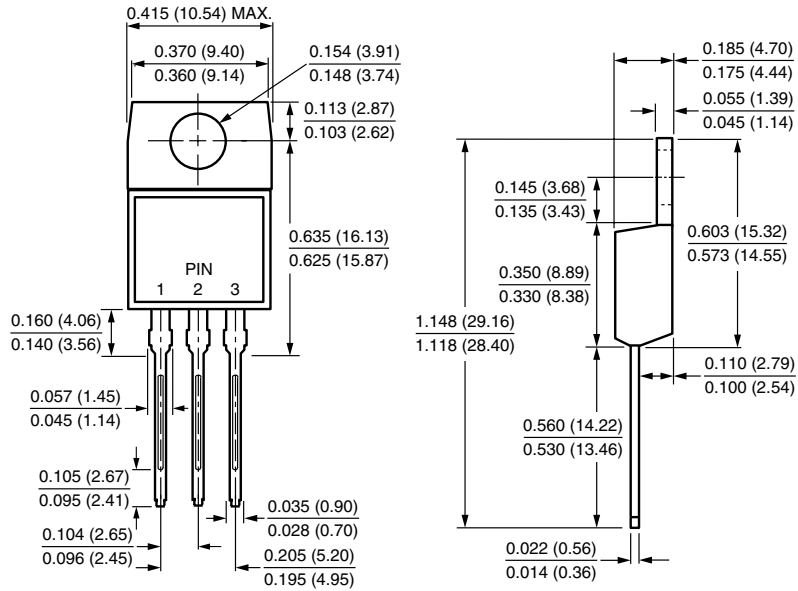

Figure 5. Typical Reverse Characteristics Per Diode



**PACKAGE OUTLINE DIMENSIONS** in inches (millimeters)

**TO-220AB**





## Disclaimer

All product specifications and data are subject to change without notice.

Vishay Intertechnology, Inc., its affiliates, agents, and employees, and all persons acting on its or their behalf (collectively, "Vishay"), disclaim any and all liability for any errors, inaccuracies or incompleteness contained herein or in any other disclosure relating to any product.

Vishay disclaims any and all liability arising out of the use or application of any product described herein or of any information provided herein to the maximum extent permitted by law. The product specifications do not expand or otherwise modify Vishay's terms and conditions of purchase, including but not limited to the warranty expressed therein, which apply to these products.

No license, express or implied, by estoppel or otherwise, to any intellectual property rights is granted by this document or by any conduct of Vishay.

The products shown herein are not designed for use in medical, life-saving, or life-sustaining applications unless otherwise expressly indicated. Customers using or selling Vishay products not expressly indicated for use in such applications do so entirely at their own risk and agree to fully indemnify Vishay for any damages arising or resulting from such use or sale. Please contact authorized Vishay personnel to obtain written terms and conditions regarding products designed for such applications.

Product names and markings noted herein may be trademarks of their respective owners.