

EVALUATION KIT
AVAILABLE

80V, 300mW Boost Converter and Current Monitor for APD Bias Applications

General Description

The MAX15031 consists of a constant-frequency pulse-width modulating (PWM) step-up DC-DC converter with an internal switch and a high-side current monitor with high-speed adjustable current limiting. This device can generate output voltages up to 76V and provides current monitoring up to 4mA (up to 300mW). The MAX15031 can be used for a wide variety of applications such as avalanche photodiode biasing, PIN biasing, or varactor biasing, and LCD displays. The MAX15031 operates from 2.7V to 11V.

The constant-frequency (400kHz), current-mode PWM architecture provides low-noise output voltage that is easy to filter. A high-voltage, internal power switch allows this device to boost output voltages up to 76V. Internal soft-start circuitry limits the input current when the boost converter starts. The MAX15031 features a shutdown mode to save power.

The MAX15031 includes a current monitor with more than three decades of dynamic range and monitors current ranging from 500nA to 2mA with high accuracy. Resistor-adjustable current limiting protects the APD from optical power transients. A clamp diode protects the monitor's output from overvoltage conditions. Other protection features include cycle-by-cycle current limiting of the boost converter switch, undervoltage lockout, and thermal shutdown if the die temperature reaches +160°C.

The MAX15031 is available in a thermally enhanced 4mm x 4mm, 16-pin TQFN package and operates over the -40°C to +125°C automotive temperature range.

Applications

Avalanche Photodiode Biasing and Monitoring
PIN Diode Bias Supplies
Low-Noise Varactor Diode Bias Supplies
FBON Modules
GPON Modules
LCD Displays

Typical Operating Circuits appear at end of data sheet.

Features

- ◆ Input Voltage Range
+2.7V to +5.5V (Using Internal Charge Pump) or
+5.5V to +11V
- ◆ Wide Output-Voltage Range from ($V_{IN} + 1V$) to 76V
- ◆ Internal 1Ω (typ) 80V Switch
- ◆ 300mW Boost Converter Output Power
- ◆ Accurate ±10% (500nA to 1mA) and ±3.5% (1mA to 4mA) High-Side Current Monitor
- ◆ Resistor-Adjustable Ultra-Fast APD Current Limit (1μs Response Time)
- ◆ Open-Drain Current-Limit Indicator Flag
- ◆ 400kHz Fixed Switching Frequency
- ◆ Constant PWM Frequency Provides Easy Filtering in Low-Noise Applications
- ◆ Internal Soft-Start
- ◆ 2μA (max) Shutdown Current
- ◆ -40°C to +125°C Temperature Range
- ◆ Small Thermally Enhanced, 4mm x 4mm, 16-Pin TQFN Package

Ordering Information

PART	TEMP RANGE	PIN-PACKAGE
MAX15031ATE+	-40°C to +125°C	16 TQFN-EP*

+Denotes a lead-free/RoHS-compliant package.

*EP = Exposed pad.

Pin Configuration

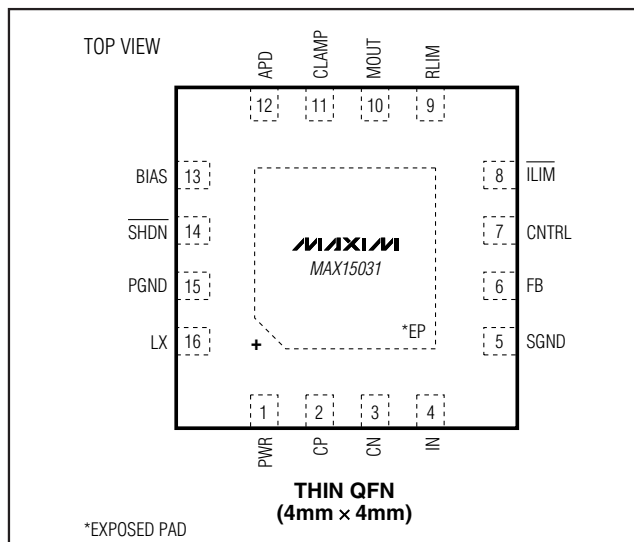

80V, 300mW Boost Converter and Current Monitor for APD Bias Applications

ABSOLUTE MAXIMUM RATINGS

PWR, IN to SGND	-0.3V to +12V
LX to PGND	-0.3V to +80V
BIAS, APD to SGND	-0.3V to +80V
SHDN to SGND	-0.3V to ($V_{IN} + 0.3V$)
CLAMP to SGND	-0.3V to ($V_{BIAS} + 0.3V$)
FB, ILIM, RLIM, CP, CN, CNTRL to SGND	-0.3V to +12V
PGND to SGND	-0.3V to +0.3V
MOUT to SGND	-0.3V to ($V_{CLAMP} + 0.3V$)

Continuous Power Dissipation 16-Pin TQFN (derate 25mW/°C above +70°C)	2000mW
Thermal Resistance (Note 1)	
θ_{JA}	40°C/W
θ_{JC}	6°C/W
Operating Temperature Range	-40°C to +125°C
Junction Temperature	+150°C
Storage Temperature Range	-65°C to +150°C
Lead Temperature (soldering, 10s)	+300°C

Note 1: Package thermal resistances were obtained using the method described in JEDEC specification JESD51-7, using a four-layer board. For detailed information on package thermal considerations, refer to www.maxim-ic.com/thermal-tutorial.

Stresses beyond those listed under "Absolute Maximum Ratings" may cause permanent damage to the device. These are stress ratings only, and functional operation of the device at these or any other conditions beyond those indicated in the operational sections of the specifications is not implied. Exposure to absolute maximum rating conditions for extended periods may affect device reliability.

ELECTRICAL CHARACTERISTICS

($V_{IN} = V_{PWR} = 3.3V$, $V_{SHDN} = 3.3V$, $C_{IN} = C_{PWR} = 10\mu F$, $C_{CP} = 10nF$, $V_{CNTRL} = V_{IN}$, $V_{RLIM} = 0V$, $PGND = SGND = 0V$, $V_{BIAS} = 40V$, APD = unconnected, CLAMP = unconnected, ILIM = unconnected, MOUT = unconnected, $T_A = T_J = -40^\circ C$ to $+125^\circ C$, unless otherwise noted. Typical values are at $T_A = +25^\circ C$.) (Note 2)

PARAMETER	SYMBOL	CONDITIONS	MIN	TYP	MAX	UNITS	
Supply Voltage Range	V_{IN} , V_{PWR}		2.7		5.5	V	
		CP connected to IN, $C_{CP} = \text{open}$	5.5		11		
Supply Current	I_{SUPPLY}	$V_{FB} = 1.4V$, no switching		1	2	mA	
		$V_{IN} = 11V$, $V_{FB} = 1.4V$ (no switching), $C_{CP} = \text{open}$, CP = IN		1.2	3		
Undervoltage Lockout Threshold	V_{UVLO}	V_{IN} rising	2.375	2.5	2.675	V	
Undervoltage Lockout Hysteresis	V_{UVLO_HYS}			100		mV	
Shutdown Current	I_{IN_SHDN}	SHDN pulled low			2	μA	
Shutdown Input Bias Current	I_{BIAS_SHDN}	$V_{BIAS} = 3.3V$, $\overline{SHDN} = 0$			30	μA	
BOOST CONVERTER							
Output-Voltage Adjustment Range			$V_{IN} + 1V$		76	V	
Switching Frequency	f_{SW}	$V_{IN} = V_{PWR} = 5V$	360	400	440	kHz	
		$2.9V \leq V_{PWR} \leq 11V$, $V_{IN} = V_{PWR}$	352	400	448		
Maximum Duty Cycle	D_{CLK}	$2.9V \leq V_{PWR} \leq 11V$, $V_{IN} = V_{PWR}$	86	90	94	%	
FB Set-Point Voltage	V_{FB}		1.2201	1.245	1.2699	V	
FB Input Bias Current	I_{FB}				100	nA	
Internal Switch On-Resistance	R_{ON}	$I_{LX} = 100mA$	$V_{PWR} = V_{IN} = 2.9V$, $V_{CP} = 5.5V$		1	2	Ω
			$V_{PWR} = V_{IN} = 5.5V$, $V_{CP} = 10V$		1	2	
		$I_{LX} = 100mA$, $V_{CP} = V_{IN}$	$V_{PWR} = V_{IN} = V_{CP} = 5.5V$		1	2	
			$V_{PWR} = V_{IN} = V_{CP} = 11V$		1	2	
Peak Switch Current Limit	I_{LIM_LX}		0.8	1.2	1.6	A	
LX Leakage Current		$V_{LX} = 36V$			1	μA	
Line Regulation		$2.9V \leq V_{PWR} \leq 11V$, $V_{PWR} = V_{IN}$, $I_{LOAD} = 4.5mA$		0.2		%	

80V, 300mW Boost Converter and Current Monitor for APD Bias Applications

MAX15031

ELECTRICAL CHARACTERISTICS (continued)

($V_{IN} = V_{PWR} = 3.3V$, $V_{SHDN} = 3.3V$, $C_{IN} = C_{PWR} = 10\mu F$, $C_{CP} = 10nF$, $V_{CNTRL} = V_{IN}$, $V_{RLIM} = 0V$, $PGND = SGND = 0V$, $V_{BIAS} = 40V$, APD = unconnected, CLAMP = unconnected, $I_{LIM} = \text{unconnected}$, MOUT = unconnected, $T_A = T_J = -40^\circ C$ to $+125^\circ C$, unless otherwise noted. Typical values are at $T_A = +25^\circ C$.) (Note 2)

PARAMETER	SYMBOL	CONDITIONS	MIN	TYP	MAX	UNITS	
Load Regulation		$0 \leq I_{LOAD} \leq 4.5mA$		1		%	
Soft-Start Duration				8		ms	
Soft-Start Steps		$(0.25 \times I_{LIM_LX})$ to I_{LIM_LX}		32		Steps	
CONTROL INPUT (CNTRL)							
Maximum Control Input Voltage Range		FB set point is regulated to V_{CNTRL}		1.25		V	
CURRENT MONITOR							
Bias Voltage Range	V_{BIAS}		10		76	V	
Bias Quiescent Current	I_{BIAS}	$I_{APD} = 500nA$			100	μA	
		$I_{APD} = 2mA$			3.2	mA	
Voltage Drop	V_{DROP}	$I_{APD} = 2mA$, $V_{DROP} = V_{BIAS} - V_{APD}$			1	V	
Dynamic Output Resistance at MOUT	R_{MOUT}	$I_{APD} = 500nA$		1		$G\Omega$	
		$I_{APD} = 2.5mA$		890		$M\Omega$	
MOUT Output Leakage		APD is unconnected		1		nA	
Output Clamp Voltage	$V_{MOUT} - V_{CLAMP}$	Forward diode current = 1mA	0.5	0.73	0.95	V	
Output Clamp Leakage Current		$V_{BIAS} = V_{CLAMP} = 76V$		1		nA	
Output-Voltage Range	V_{MOUT}	$10V \leq V_{BIAS} \leq 76V$, $0 \leq I_{APD} \leq 1mA$, CLAMP is unconnected	$V_{BIAS} - 1V$			V	
Current Gain	I_{MOUT}/I_{APD}	$I_{APD} = 500nA$	0.095	0.1	0.11		
		$I_{APD} = 2mA$	0.965	0.1	0.1035		
Power-Supply Rejection Ratio	PSRR	$(\Delta I_{MOUT}/I_{MOUT})/\Delta V_{BIAS}$, $V_{BIAS} = 10V$ to $76V$	$I_{APD} = 500nA$	-1000	+300	+1500	ppm/V
			$I_{APD} = 1mA$	-250	+24	+250	
APD Input Current Limit	I_{LIM_APD}	$V_{APD} = 35V$, $R_{LIM} = 3.3k\Omega$	3.15	3.75	4.35	mA	
Current-Limit Adjustment Range		$12.45k\Omega \geq R_{LIM} \geq 2.5k\Omega$	1		5	mA	
Power-Up Settling Time	t_S	I_{MOUT} settles to within 0.1%, 10nF connected from APD to ground	$I_{APD} = 500nA$	7.5		ms	
			$I_{APD} = 2.5mA$	90		μs	
LOGIC INPUTS/OUTPUTS							
SHDN Input-Voltage Low	V_{IL}				0.8	V	
SHDN Input-Voltage High	V_{IH}		2.4			V	
I_{LIM} Output-Voltage Low	V_{OL}	$I_{LIM} = 2mA$			0.3	V	
I_{LIM} Output Leakage Current	I_{OH}	$V_{LIM} = 11V$			1	μA	
THERMAL PROTECTION							
Thermal Shutdown		Temperature rising		+160		$^\circ C$	
Thermal Shutdown Hysteresis				10		$^\circ C$	

Note 2: All minimum/maximum parameters are tested at $T_A = +125^\circ C$. Limits over temperature are guaranteed by design.

80V, 300mW Boost Converter and Current Monitor for APD Bias Applications

Typical Operating Characteristics

($V_{PWR} = V_{IN} = 3.3V$, $V_{OUT} = 70V$, circuit of Figure 3 (Figure 4 for $V_{IN} > 5.5V$), unless otherwise noted.)

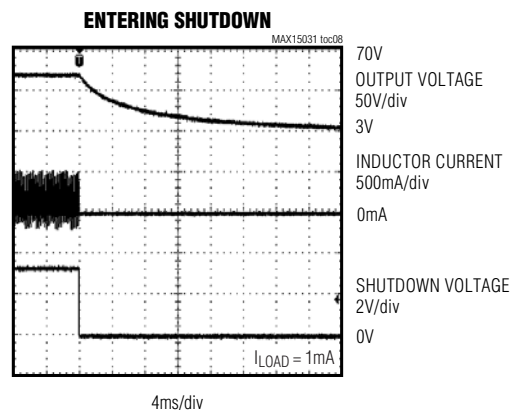
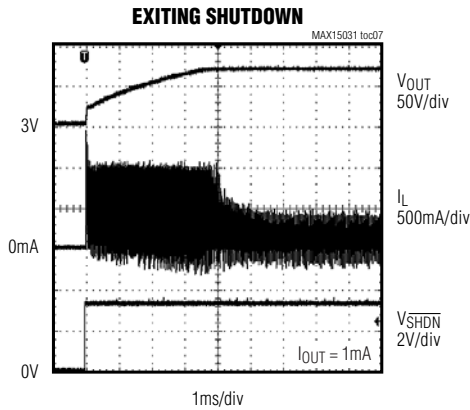
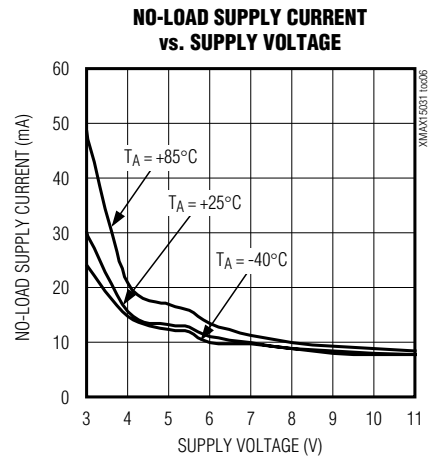
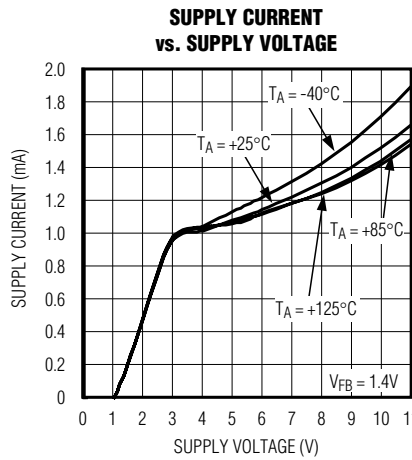
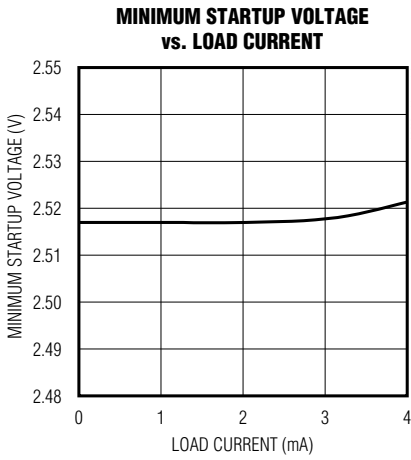
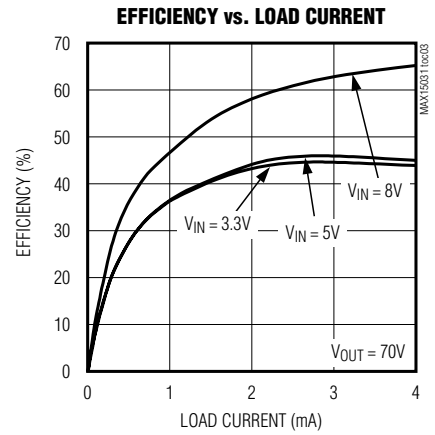
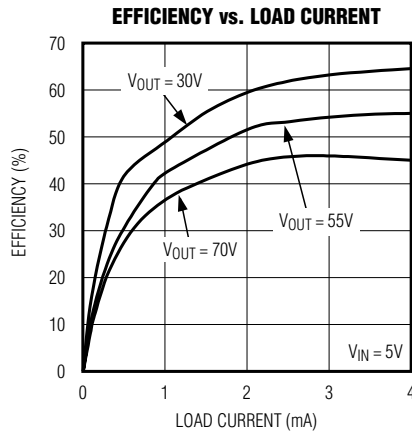
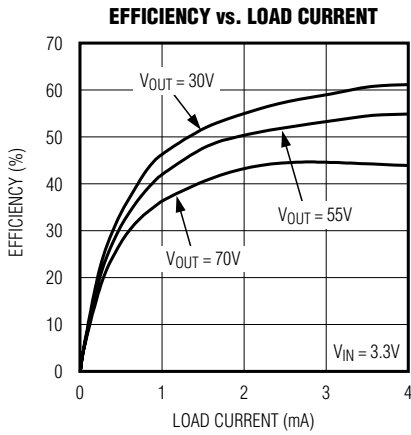

80V, 300mW Boost Converter and Current Monitor for APD Bias Applications

MAX15031

Typical Operating Characteristics (continued)

($V_{PWR} = V_{IN} = 3.3V$, $V_{OUT} = 70V$, circuit of Figure 3 (Figure 4 for $V_{IN} > 5.5V$), unless otherwise noted.)

LIGHT-LOAD SWITCHING WAVEFORM WITH RC FILTER

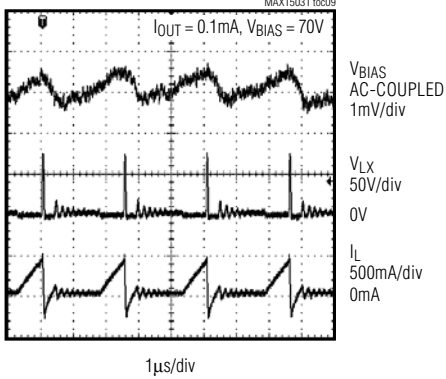

HEAVY-LOAD SWITCHING WAVEFORM WITH RC FILTER

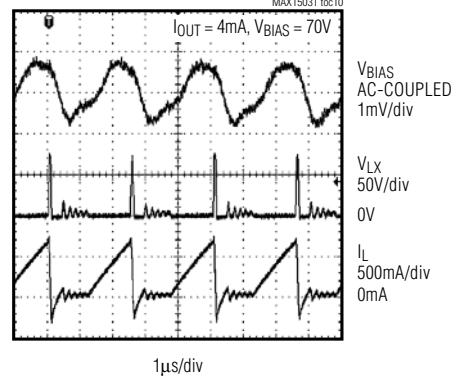

LOAD-TRANSIENT RESPONSE

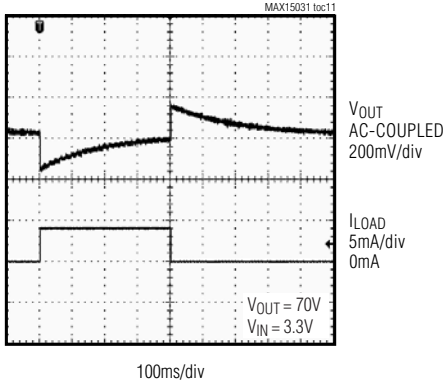

LINE-TRANSIENT RESPONSE

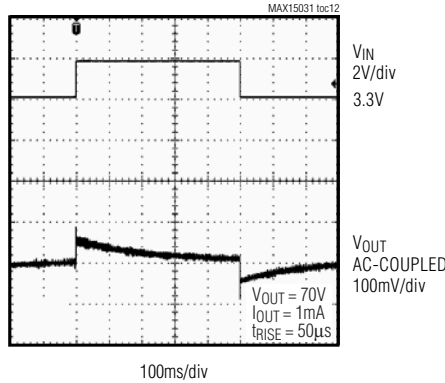

LX LEAKAGE CURRENT vs. TEMPERATURE

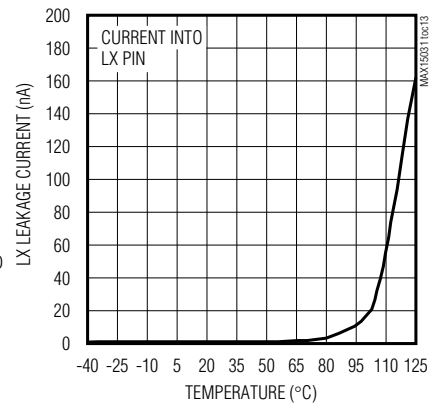

LOAD REGULATION

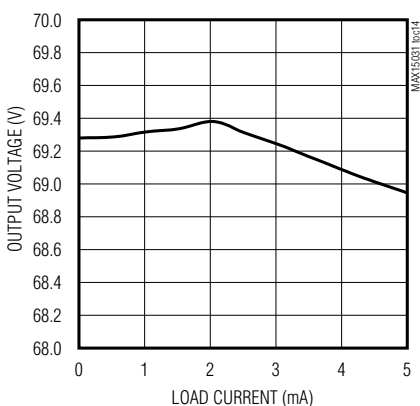

MAXIMUM LOAD CURRENT vs. INPUT VOLTAGE

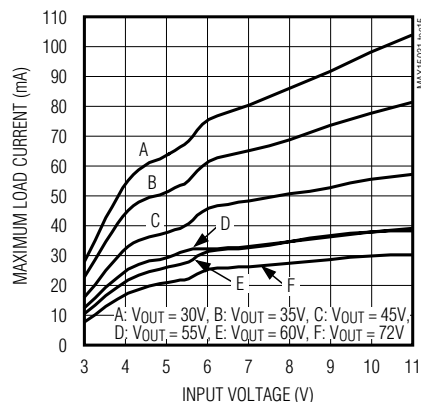

BIAS CURRENT vs. BIAS VOLTAGE

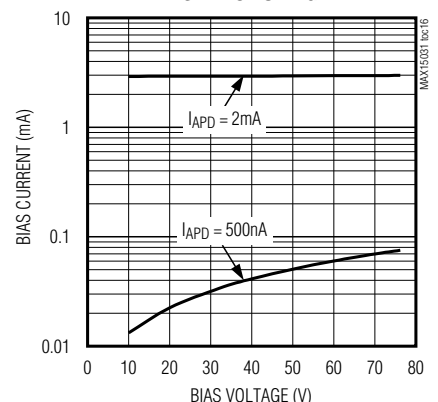

80V, 300mW Boost Converter and Current Monitor for APD Bias Applications

Typical Operating Characteristics (continued)

($V_{PWR} = V_{IN} = 3.3V$, $V_{OUT} = 70V$, circuit of Figure 3 (Figure 4 for $V_{IN} > 5.5V$), unless otherwise noted.)

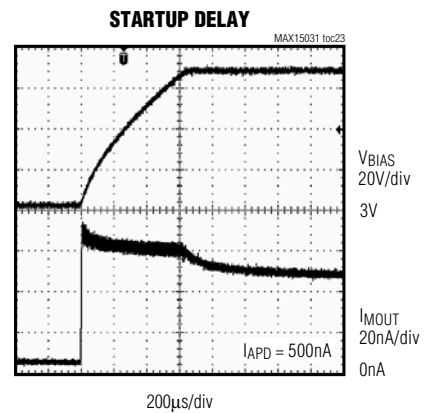
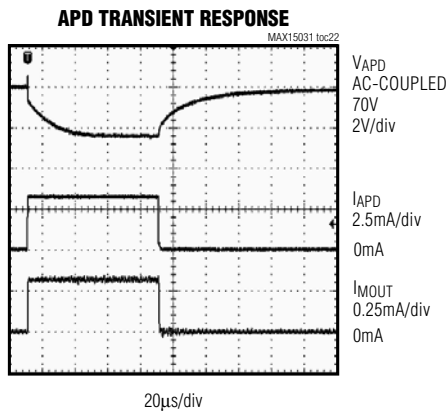
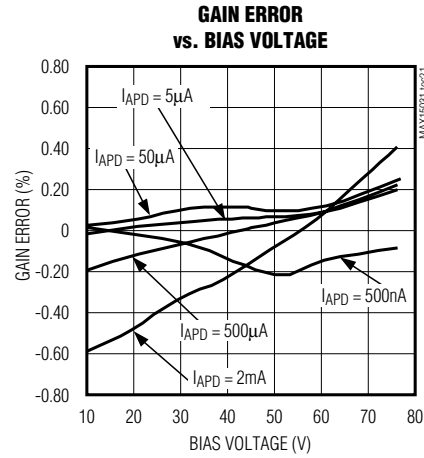
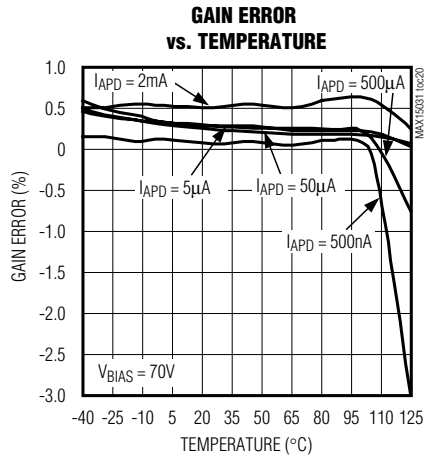
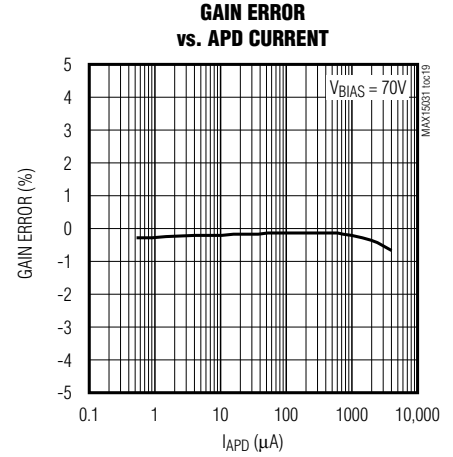
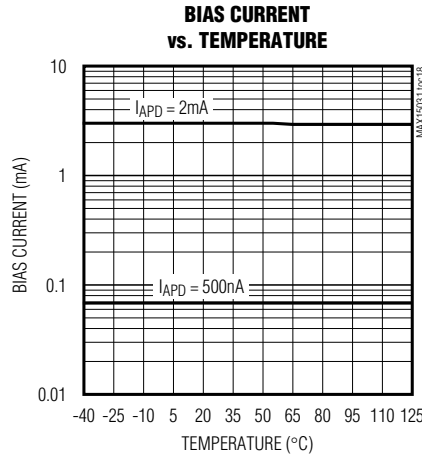
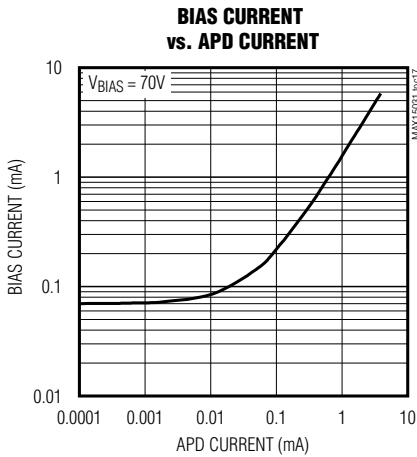

80V, 300mW Boost Converter and Current Monitor for APD Bias Applications

MAX15031

Typical Operating Characteristics (continued)

($V_{PWR} = V_{IN} = 3.3V$, $V_{OUT} = 70V$, circuit of Figure 3 (Figure 4 for $V_{IN} > 5.5V$), unless otherwise noted.)

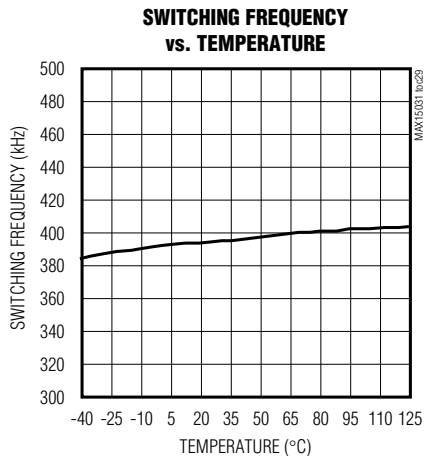
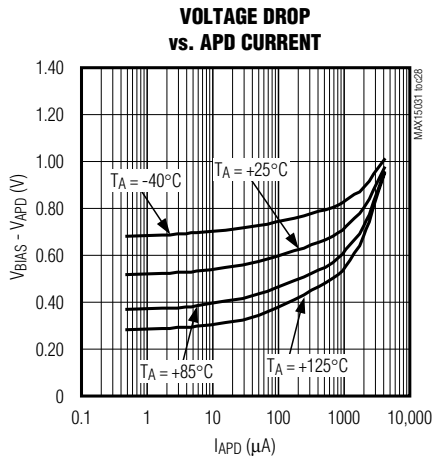
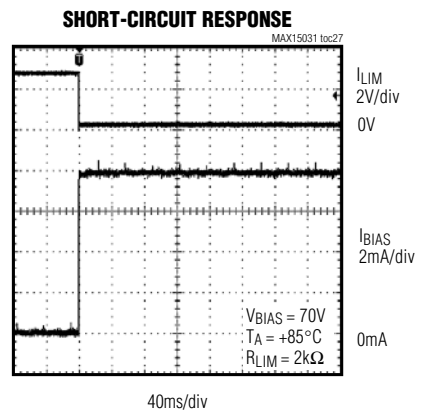
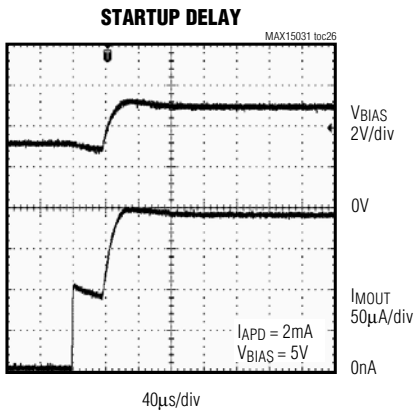
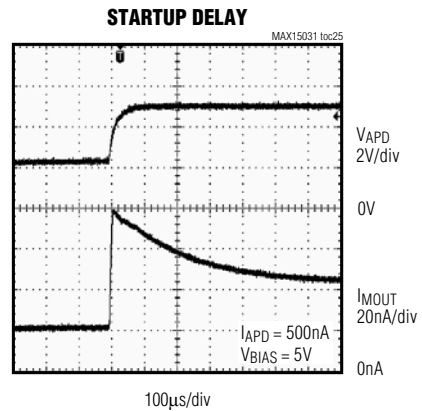
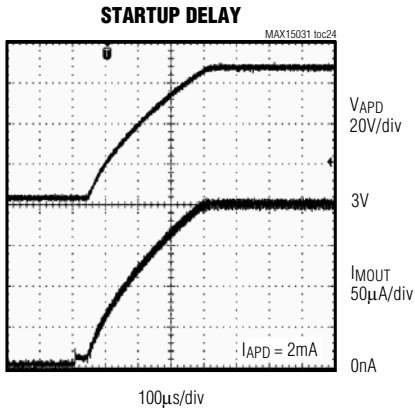

80V, 300mW Boost Converter and Current Monitor for APD Bias Applications

Typical Operating Characteristics (continued)

($V_{PWR} = V_{IN} = 3.3V$, $V_{OUT} = 70V$, circuit of Figure 3 (Figure 4 for $V_{IN} > 5.5V$), unless otherwise noted.)

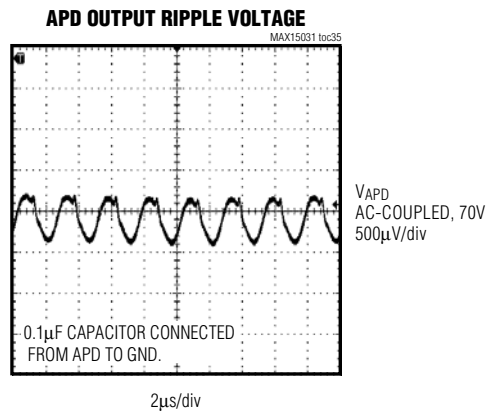
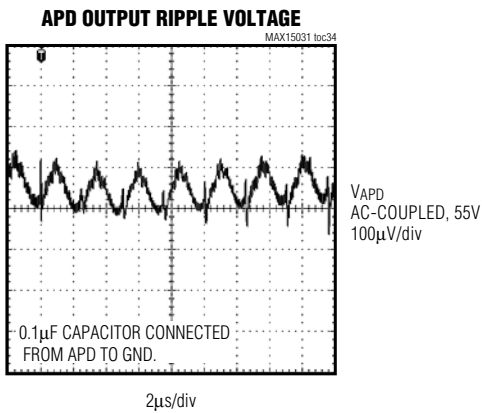
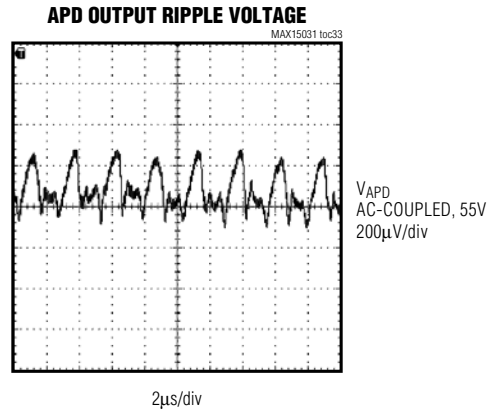
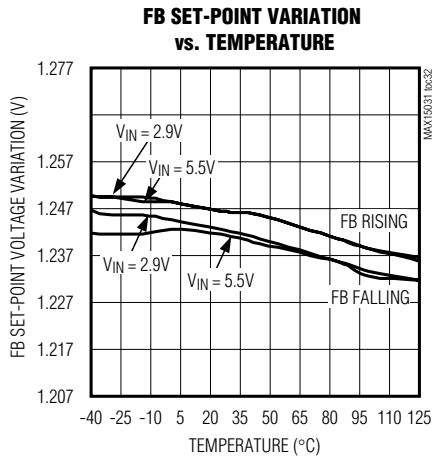
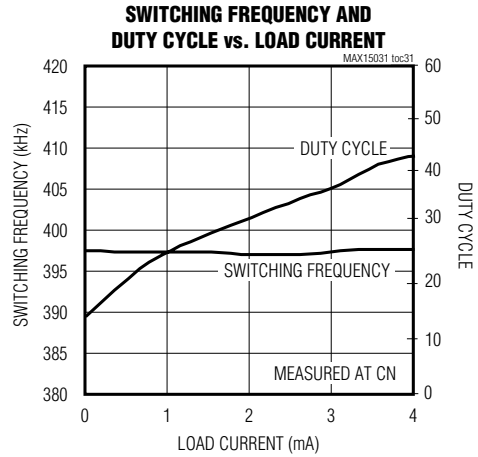
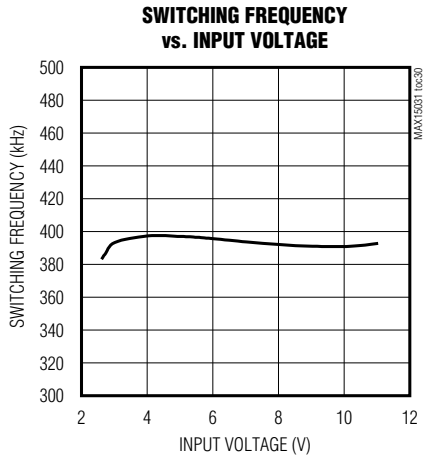

80V, 300mW Boost Converter and Current Monitor for APD Bias Applications

Pin Description

PIN	NAME	FUNCTION
1	PWR	Boost Converter Input Voltage. PWR powers the switch driver and charge pump. Bypass PWR to PGND with a ceramic capacitor of 1 μ F minimum value.
2	CP	Positive Terminal of the Charge-Pump Flying Capacitor for 2.7V to 5.5V Supply Voltage Operation. Connect CP to IN when the input voltage is in the 5.5V to 11V range.
3	CN	Negative Terminal of the Charge-Pump Flying Capacitor for 2.7V to 5.5V Supply Voltage Operation. Leave CN unconnected when the input voltage is in the 5.5V to 11V range.
4	IN	Input Supply Voltage. IN powers all blocks of the MAX15031 except the switch driver and charge pump. Bypass IN to PGND with a ceramic capacitor of 1 μ F minimum value.
5	SGND	Signal Ground. Connect directly to the local ground plane. Connect SGND to PGND at a single point, typically near the return terminal of the output capacitor.
6	FB	Feedback Regulation Input. Connect FB to the center tap of a resistive voltage-divider from the output (V _{OUT}) to SGND to set the output voltage. The FB voltage regulates to 1.245V (typ) when V _{CNTRL} is above 1.5V (typ) and to V _{CNTRL} voltage when V _{CNTRL} is below 1.245V (typ).
7	CNTRL	Control Input for Boost Converter Output-Voltage Programmability. Allows the feedback set-point voltage to be set externally by CNTRL when CNTRL is less than 1.245V. Pull CNTRL above 1.5V (typ) to use the internal 1.245V (typ) feedback set-point voltage.
8	$\overline{\text{ILIM}}$	Open-Drain Current-Limit Indicator. $\overline{\text{ILIM}}$ asserts low when the APD current limit has been exceeded.
9	RLIM	Current-Limit Resistor Connection. Connect a resistor from RLIM to SGND to program the APD current-limit threshold.
10	MOUT	Current-Monitor Output. MOUT sources a current 1/10th of I _{APD} .
11	CLAMP	Clamp Voltage Input. CLAMP is the external potential used for voltage clamping of MOUT.
12	APD	Reference Current Output. APD provides the source current to the cathode of the photodiode.
13	BIAS	Bias Voltage Input. Connect BIAS to the boost converter output (V _{OUT}) either directly or through a lowpass filter for ripple attenuation. BIAS provides the voltage bias for the current monitor and is the current source for APD.
14	$\overline{\text{SHDN}}$	Active-Low Shutdown Control Input. Apply a logic-low voltage to $\overline{\text{SHDN}}$ to shut down the device and reduce the supply current to 2 μ A (max). Connect $\overline{\text{SHDN}}$ to IN for normal operation. Ensure that V _{SHDN} is not greater than the input voltage, V _{IN} .
15	PGND	Power Ground. Connect the negative terminals of the input and output capacitors to PGND. Connect PGND externally to SGND at a single point, typically at the return terminal of the output capacitor.
16	LX	Drain of Internal 80V n-Channel DMOS. Connect inductor and diode to LX. Minimize the trace area at LX to reduce switching noise emission.
—	EP	Exposed Pad. Connect EP to a large contiguous copper plane at SGND potential to improve thermal dissipation. Do not use as the main SGND connection.

MAX15031

80V, 300mW Boost Converter and Current Monitor for APD Bias Applications

Functional Diagram

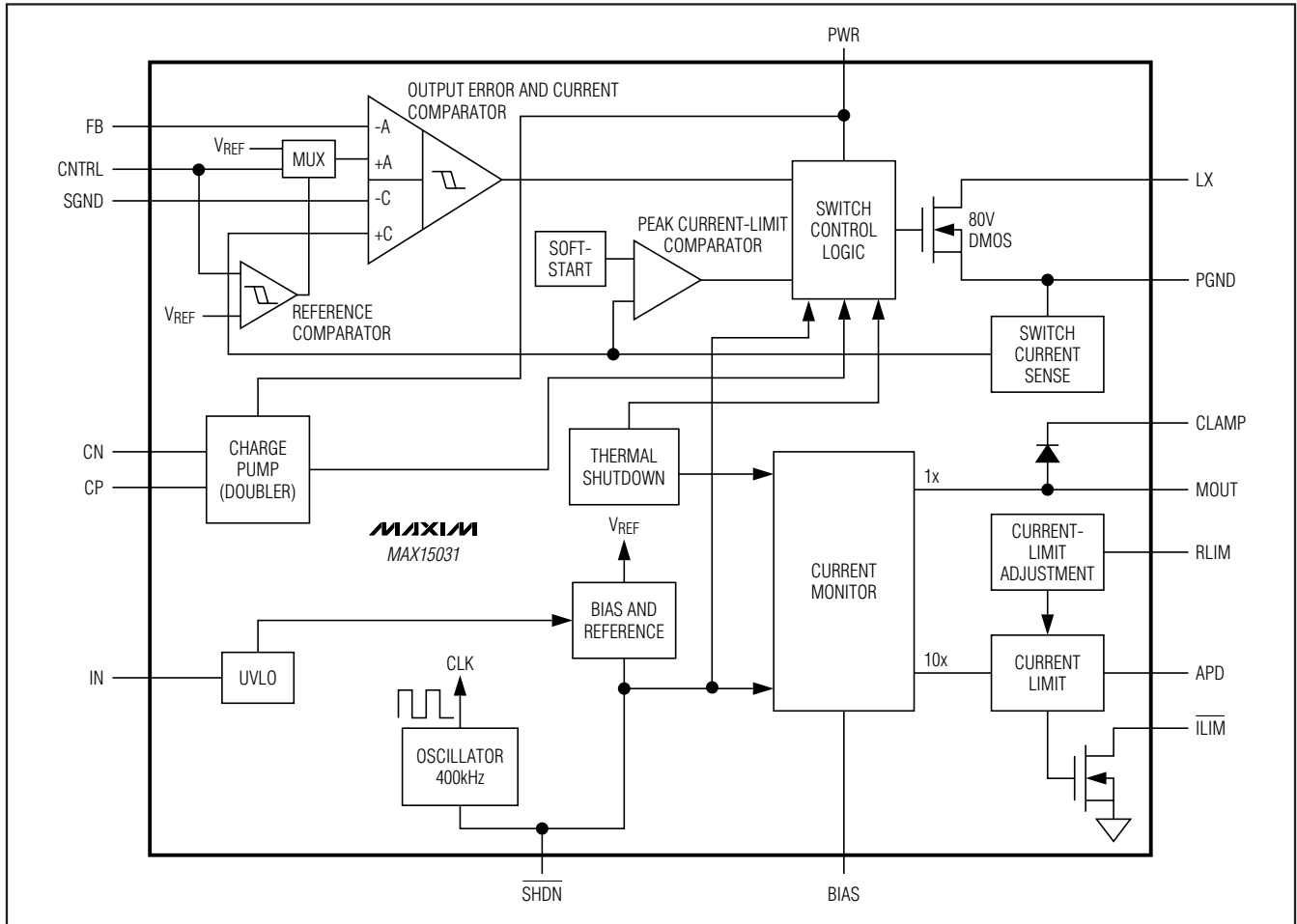

Detailed Description

The MAX15031 constant-frequency, current-mode, PWM boost converter is intended for low-voltage systems that require a locally generated high voltage. This device can generate a low-noise, high output voltage required for PIN and varactor diode biasing and LCD displays. The MAX15031 operates either from +2.7V to +5.5V or from +5.5V to +11V. For 2.7V to 5.5V operation, an internal charge pump with an external 10nF ceramic capacitor is used. For 5.5V to 11V operation, connect CP to IN and leave CN unconnected.

The MAX15031 operates in discontinuous mode in order to reduce the switching noise caused by reverse-voltage recovery charge of the rectifier diode. Other continuous mode boost converters generate large voltage spikes at the output when the LX switch turns on

because there is a conduction path between the output, diode, and switch to ground during the time needed for the diode to turn off and reverse its bias voltage. To reduce the output noise even further, the LX switch turns off by taking 10ns typically to transition from ON to OFF. As a consequence, the positive slew rate of the LX node is reduced and the current from the inductor does not “force” the output voltage as hard as would be the case if the LX switch were to turn off faster.

The constant-frequency (400kHz) PWM architecture generates an output voltage ripple that is easy to filter. An 80V vertical DMOS device used as the internal power switch is ideal for boost converters with output voltages up to 76V. The MAX15031 can also be used in other topologies where the PWM switch is grounded, like SEPIC and flyback converters.

80V, 300mW Boost Converter and Current Monitor for APD Bias Applications

The MAX15031 includes a versatile current monitor intended for monitoring the APD, PIN, or varactor diode DC current in fiber and other applications. The MAX15031 features more than three decades of dynamic current ranging from 500nA to 4mA and provides an output current accurately proportional to the APD current at MOUT.

The MAX15031 also features a shutdown logic input to disable the device and reduce its standby current to 2 μ A (max).

Fixed-Frequency PWM Controller

The heart of the MAX15031 current-mode PWM controller is a BiCMOS multiple-input comparator that simultaneously processes the output-error signal and switch current signal. The main PWM comparator uses direct summing, lacking a traditional error amplifier and its associated phase shift. The direct summing configuration approaches ideal cycle-by-cycle control over the output voltage since there is no conventional error amplifier in the feedback path.

The device operates in PWM mode using a fixed-frequency, current-mode operation. The current-mode frequency loop regulates the peak inductor current as a function of the output error signal.

The current-mode PWM controller is intended for DCM (discontinuous conduction mode) operation. No internal slope compensation is added to the current signal.

Charge Pump

At low supply voltages (2.7V to 5.5V), internal charge-pump circuitry and an external 10nF ceramic capacitor connected between CP and CN double the available internal supply voltage to drive the internal switch efficiently.

In the 5.5V to 11V supply voltage range, the charge pump is not required. In this configuration, disable the charge pump by connecting CP to IN and leaving CN unconnected.

Monitor Current Limit (RLIM)

The current limit of the current monitor is programmable from 1mA to 5mA. Connect a resistor from RLIM to ground to program the current-limit threshold up to 5mA.

The current monitor mirrors the current out of APD with a 1:10 ratio, and the MOUT current can be converted to a voltage signal by connecting a resistor from MOUT to SGND.

The APD current-monitor range is from 500nA to 4mA, and the MOUT current-mirror output accuracy is $\pm 10\%$ from 500nA to 1mA of APD current and $\pm 3.5\%$ from 1mA to 4mA of APD current.

Clamping the Monitor Output Voltage (CLAMP)

CLAMP provides a means for diode clamping the voltage at MOUT; thus V_{MOUT} is limited to ($V_{CLAMP} + 0.6V$). CLAMP can be connected to either an external supply or BIAS. CLAMP can be left unconnected if voltage clamping is not required.

Adjusting the Boost Converter Output Voltage (FB/CNTRL)

The boost converter output voltage can be set by connecting FB to a resistor-divider from V_{OUT} to ground. The set-point feedback reference is the 1.245 (typ) internal reference voltage when $V_{CNTRL} > 1.5V$ and is equal to the CNTRL voltage when $V_{CNTRL} < 1.25V$.

To change the converter output on the fly, apply a voltage lower than 1.25V (typ) to the CNTRL input and adjust the CNTRL voltage, which is the reference input of the error amplifier when $V_{CNTRL} < 1.25V$ (see the *Functional Diagram*). This feature can be used to adjust the APD voltage based on the APD mirror current, which compensates for the APD avalanche gain variation with temperature and manufacturing process. As shown in Figure 4, the voltage signal proportional to the MOUT current is connected to the ADC (analog to digital) input of the APD module, which then controls the reference voltage of the boost converter error amplifier through a DAC (digital to analog) block connected to the CNTRL input. The BIAS voltage and, therefore, the APD current, are controlled based on the MOUT mirror current, forming a negative feedback loop.

Shutdown (SHDN)

The MAX15031 features an active-low shutdown input (\overline{SHDN}). Pull \overline{SHDN} low to enter shutdown. During shutdown, the supply current drops to 2 μ A (30 μ A from BIAS) (max). However, the output remains connected to the input through the inductor and the output diode, holding the output voltage to one diode drop below PWR when the MAX15031 shuts down. Connect \overline{SHDN} to IN for always-on operation.

80V, 300mW Boost Converter and Current Monitor for APD Bias Applications

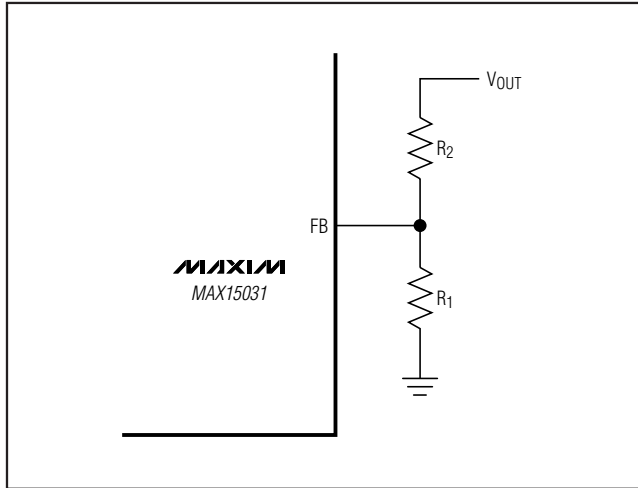

Figure 1. Adjustable Output Voltage

Design Procedure

Setting the Output Voltage

Set the MAX15031 output voltage by connecting a resistive divider from the output to FB to SGND (Figure 1). Select R_1 (FB to SGND resistor) between 200k Ω and 400k Ω . Calculate R_2 (V_{OUT} to FB resistor) using the following equation:

$$R_2 = R_1 \left[\left(\frac{V_{OUT}}{V_{REF}} \right) - 1 \right]$$

where V_{OUT} can range from ($V_{IN} + 1V$) to 76V and $V_{REF} = 1.245V$ or V_{CNTRL} depending on the V_{CNTRL} value. For $V_{CNTRL} > 1.5V$, the internal 1.245V (typ) reference voltage is used as the feedback set point ($V_{REF} = 1.245V$) and for $V_{CNTRL} < 1.25V$, $V_{REF} = V_{CNTRL}$.

Determining Peak Inductor Current

If the boost converter remains in the discontinuous mode of operation, then the approximate peak inductor current, I_{LPEAK} (in amperes), is represented by the formula below:

$$I_{LPEAK} = \sqrt{\frac{2 \times T_S \times (V_{OUT} - V_{IN_MIN}) \times I_{OUT_MAX}}{\eta \times L}}$$

where T_S is the switching period in microseconds, V_{OUT} is the output voltage in volts, V_{IN_MIN} is the minimum input voltage in volts, I_{OUT_MAX} is the maximum

output current in amperes, L is the inductor value in microhenrys, and η is the efficiency of the boost converter (see the *Typical Operating Characteristics*).

Determining the Inductor Value

Three key inductor parameters must be specified for operation with the MAX15031: inductance value (L), inductor saturation current (I_{SAT}), and DC resistance (DCR). In general, the inductor should have a saturation current rating greater than the maximum switch peak current-limit value ($I_{LIM_LX} = 1.6A$). Choose an inductor with a low-DCR resistance for reasonable efficiency.

Use the following formula to calculate the lower bound of the inductor value at different output voltages and output currents. This is the minimum inductance value for discontinuous mode operation for supplying full 300mW of output power.

$$L_{MIN}[\mu H] = \frac{2 \times T_S \times I_{OUT} \times (V_{OUT} - V_{IN_MIN})}{\eta \times I_{LIM_LX}^2}$$

where V_{IN_MIN} , V_{OUT} (both in volts), and I_{OUT} (in amperes) are typical values (so that efficiency is optimum for typical conditions), T_S (in microseconds) is the period, η is the efficiency, and I_{LIM_LX} is the peak switch current in amperes (see the *Electrical Characteristics* table).

Calculate the optimum value of L ($L_{OPTIMUM}$) to ensure the full output power without reaching the boundary between continuous conduction mode (CCM) and DCM using the following formula:

$$L_{OPTIMUM}[\mu H] = \frac{L_{MAX}[\mu H]}{2.25}$$

$$\text{where } L_{MAX}[\mu H] = \frac{V_{IN_MIN}^2 (V_{OUT} - V_{IN_MIN}) \times T_S \times \eta}{2 \times I_{OUT} \times V_{OUT}^2}$$

For a design in which $V_{IN} = 3.3V$, $V_{OUT} = 70V$, $I_{OUT} = 3mA$, $\eta = 45\%$, $I_{LIM_LX} = 1.3A$, and $T_S = 2.5\mu s$: $L_{MIN} = 1.3\mu H$ and $L_{MAX} = 23\mu H$.

For a worse-case scenario in which $V_{IN} = 2.9V$, $V_{OUT} = 70V$, $I_{OUT} = 4mA$, $\eta = 43\%$, $I_{LIM_LX} = 1.3A$, and $T_S = 2.5\mu s$: $L_{MIN} = 1.8\mu H$ and $L_{MAX} = 15\mu H$.

The choice of 4.7 μH is reasonable given the worst-case scenario above. In general, the higher the inductance, the lower the switching noise. Load regulation is also better with higher inductance.

80V, 300mW Boost Converter and Current Monitor for APD Bias Applications

Diode Selection

The MAX15031's high switching frequency demands a high-speed rectifier. Schottky diodes are recommended for most applications because of their fast recovery time and low forward-voltage drop. Ensure that the diode's peak current rating is greater than the peak inductor current. Also the diode reverse-breakdown voltage must be greater than V_{OUT} . The output voltage of the boost converter.

Output Filter Capacitor Selection

For most applications, use a small output capacitor of 0.1 μ F or greater. To achieve low output ripple, a capacitor with low ESR, low ESL, and high capacitance value should be selected. If tantalum or electrolytic capacitors are used to achieve high capacitance values, always add a smaller ceramic capacitor in parallel to bypass the high-frequency components of the diode current. The higher ESR and ESL of electrolytic capacitors increase the output ripple and peak-to-peak transient voltage. Assuming the contribution from the ESR and capacitor discharge equals 50% (proportions may vary), calculate the output capacitance and ESR required for a specified ripple using the following equations:

$$C_{OUT}[\mu F] = \frac{I_{OUT}}{0.5 \times \Delta V_{OUT}} \left[T_S - \frac{I_{LPEAK} \times L_{OPTIMUM}}{(V_{OUT} - V_{IN_MIN})} \right]$$

$$ESR[m\Omega] = \frac{0.5 \times \Delta V_{OUT}}{I_{OUT}}$$

For very low output ripple applications, the output of the boost converter can be followed by an RC filter to further reduce the ripple. Figure 2 shows a 100 Ω (R_F), 0.1 μ F (C_F) filter used to reduce the switching output ripple to 1mV_{P-P} with a 0.1mA load or 2mV_{P-P} with a 4mA load. The output-voltage regulation resistor-divider must remain connected to the diode and output capacitor node.

Use X7R ceramic capacitors for more stability over the full temperature range. Use an X5R capacitor for -40°C to +85°C applications.

Input Capacitor Selection

Bypass PWR to PGND with a 1 μ F (min) ceramic capacitor and bypass IN to PGND with a 1 μ F (min) ceramic capacitor. Depending on the supply source impedance, higher values may be needed. Make sure that the input capacitors are close enough to the IC to provide adequate decoupling at IN and PWR as well. If the layout cannot achieve this, add another 0.1 μ F ceramic capacitor between IN and PGND (or PWR and PGND) in the immediate vicinity of the IC. Bulk aluminum electrolytic capacitors may be needed to avoid chattering at low input voltage. In case of aluminum electrolytic capacitors, calculate the capacitor value and ESR of the input capacitor using the following equations:

$$C_{IN}[\mu F] = \frac{V_{OUT} \times I_{OUT}}{\eta \times V_{IN_MIN} \times 0.5 \times \Delta V_{IN}} \left[T_S - \frac{I_{LPEAK} \times L_{OPTIMUM} \times V_{OUT}}{V_{IN_MIN}(V_{OUT} - V_{IN_MIN})} \right]$$

$$ESR[m\Omega] = \frac{0.5 \times \Delta V_{IN} \times \eta \times V_{IN_MIN}}{V_{OUT} \times I_{OUT}}$$

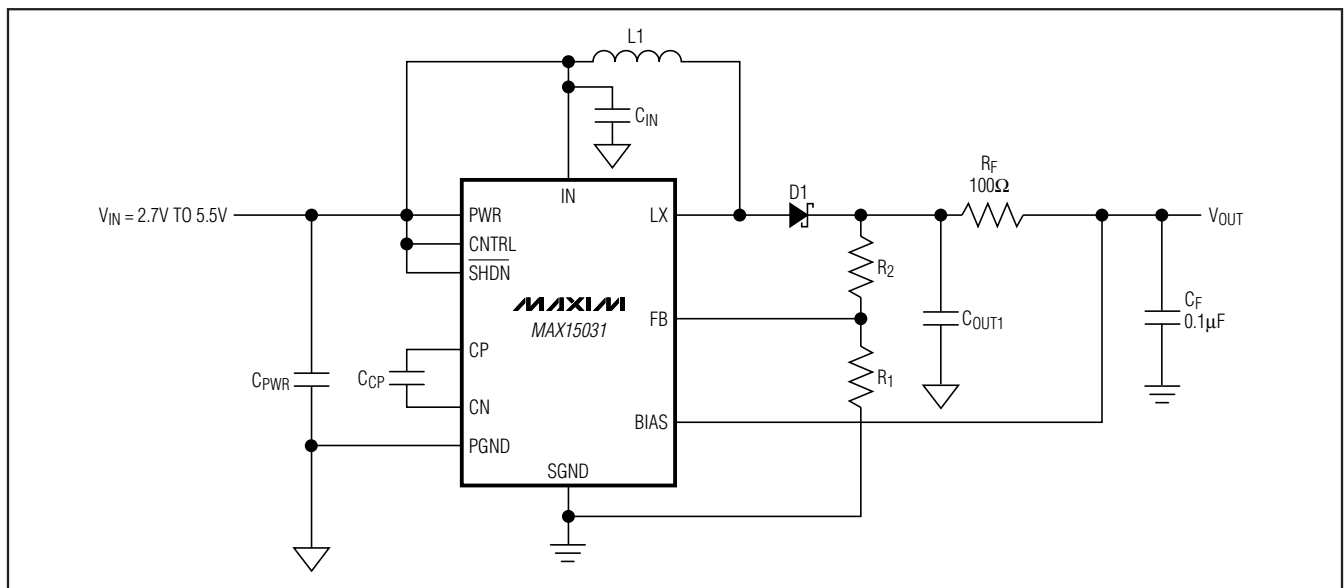

Figure 2. Typical Operating Circuit with RC Filter

80V, 300mW Boost Converter and Current Monitor for APD Bias Applications

Determining Monitor Current Limit

Calculate the value of the monitor current-limit resistor, R_{LIM} , for a given APD current limit, I_{LIMIT} , using the following equation:

$$R_{LIM} = 10 \times \frac{1.245V}{I_{LIMIT}(mA)}$$

The R_{LIM} resistor, R_{LIM} , ranges from 12.45k Ω to 2.5 Ω for APD currents from 1mA to 5mA.

Applications Information

Using APD or PIN Photodiodes in Fiber Applications

When using the MAX15031 to monitor APD or PIN photodiode currents in fiber applications, several issues must be addressed. In applications where the photodiode must be fully depleted, keep track of voltages budgeted for each component with respect to the available supply voltage(s). The current monitors require as much as 1.1V between BIAS and APD, which must be considered part of the overall voltage budget.

Additional voltage margin can be created if a negative supply is used in place of a ground connection, as long as the overall voltage drop experienced by the MAX15031 is less than or equal to 76V. For this type of application, the MAX15031 is suggested so the output can be referenced to “true” ground and not the negative supply. The MAX15031’s output current can be referenced as desired with either a resistor to ground or a transimpedance amplifier. Take care to ensure that output voltage excursions do not interfere with the required margin between BIAS and MOUT. In many fiber applications, MOUT is connected directly to an ADC that operates from a supply voltage that is less than the voltage at BIAS. Connecting the MAX15031’s clamping diode output, CLAMP, to the ADC power supply helps avoid damage to the ADC. Without this protection, voltages can develop at MOUT that might destroy the ADC. This

protection is less critical when MOUT is connected directly to subsequent transimpedance amplifiers (linear or logarithmic) that have low-impedance, near-ground-referenced inputs. If a transimpedance amplifier is used on the low side of the photodiode, its voltage drop must also be considered. Leakage from the clamping diode is most often insignificant over nominal operating conditions, but grows with temperature.

To maintain low levels of wideband noise, lowpass filtering the output signal is suggested in applications where only DC measurements are required. Connect the filter capacitor at MOUT. Determining the required filtering components is straightforward, as the MAX15031 exhibits a very high output impedance of 890M Ω .

In some applications where pilot tones are used to identify specific fiber channels, higher bandwidths are desired at MOUT to detect these tones. Consider the minimum and maximum currents to be detected, then consult the frequency response and noise typical operating curves. If the minimum current is too small, insufficient bandwidth could result, while too high a current could result in excessive noise across the desired bandwidth.

Layout Considerations

Careful PCB layout is critical to achieve low switching losses and clean and stable operation. Protect sensitive analog grounds by using a star ground configuration. Connect SGND and PGND together close to the device at the return terminal of the output bypass capacitor. Do not connect them together anywhere else. Keep all PCB traces as short as possible to reduce stray capacitance, trace resistance, and radiated noise. Ensure that the feedback connection to FB is short and direct. Route high-speed switching nodes away from the sensitive analog areas. Use an internal PCB layer for SGND as an EMI shield to keep radiated noise away from the device, feedback dividers, and analog bypass capacitors. Refer to the MAX15031 evaluation kit data sheet for a layout example.

80V, 300mW Boost Converter and Current Monitor for APD Bias Applications

Typical Operating Circuits

MAX15031

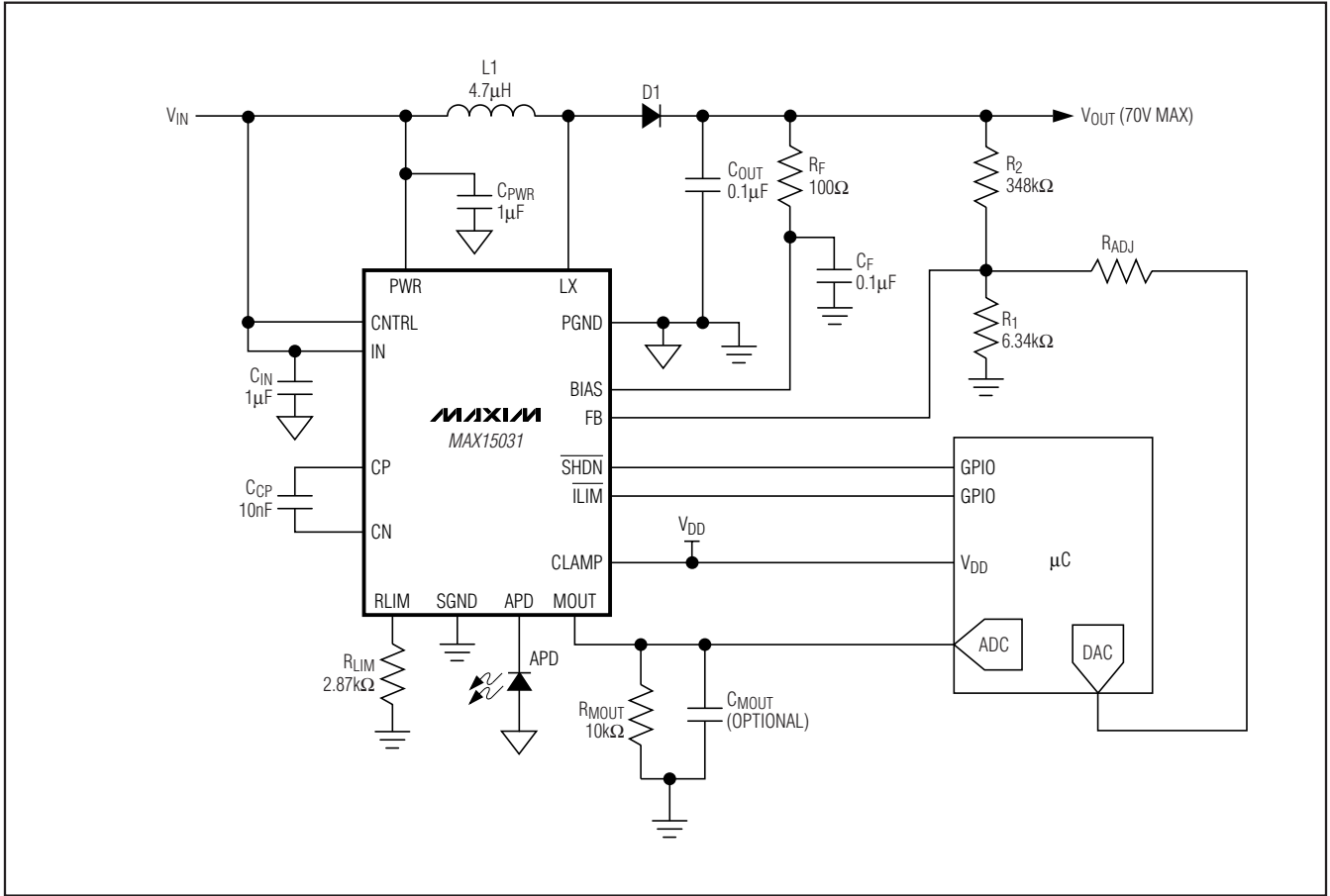

Figure 3. Typical Operating Circuit for $V_{IN} = 2.7V$ to $5.5V$

80V, 300mW Boost Converter and Current Monitor for APD Bias Applications

Typical Operating Circuits (continued)

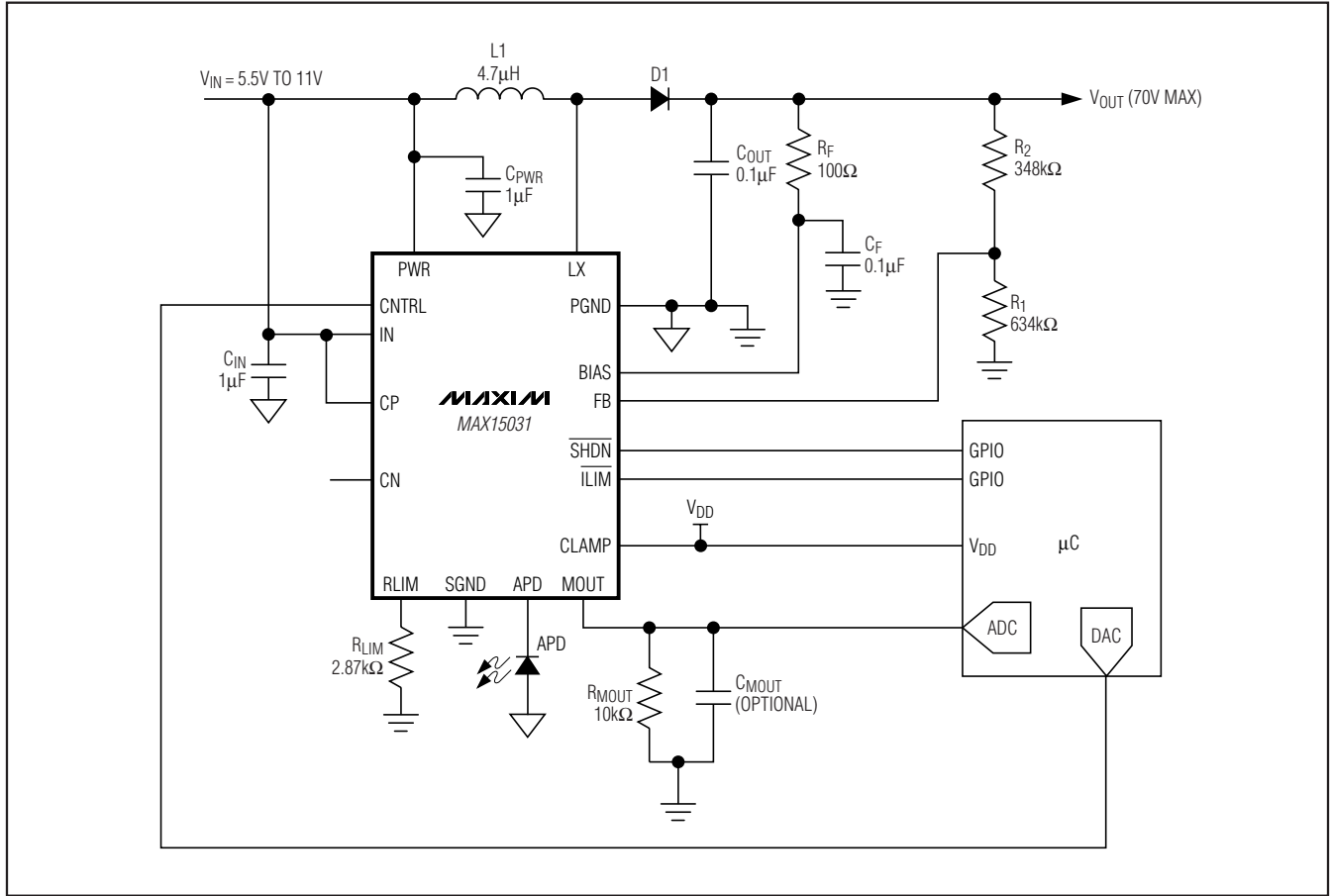

Figure 4. Typical Operating Circuit for $V_{IN} = 5.5V$ to $11V$

Chip Information

PROCESS: BiCMOS

Package Information

For the latest package outline information and land patterns, go to www.maxim-ic.com/packages.

PACKAGE TYPE	PACKAGE CODE	DOCUMENT NO.
16 TQFN	T1644-4	21-0139

Maxim cannot assume responsibility for use of any circuitry other than circuitry entirely embodied in a Maxim product. No circuit patent licenses are implied. Maxim reserves the right to change the circuitry and specifications without notice at any time.

16 Maxim Integrated Products, 120 San Gabriel Drive, Sunnyvale, CA 94086 408-737-7600