

RoHS Compliant Product

Description

The S5U2187 of positive, linear regulators feature low quiescent current (45µA typ.) with low dropout voltage, making them ideal for battery applications. Output voltage are set at the factory and trimmed to 1.5% accuracy. These rugged devices have both Thermal Shutdown and Current Fold-back to prevent device failure under the "Worst" of operating conditions. The S5U2187 is stable with an output capacitance of 4.7µF or greater.

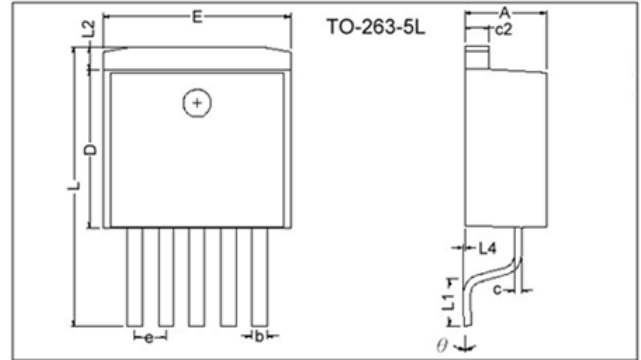

Features

- * Low Temperature Coefficient
- * Over-Temperature Shutdown
- * Adjustable Version
- * Very Low Dropout Voltage
- * Noise Reduction Bypass Capacitor
- * Short Circuit Current Fold-back
- * Guaranteed 750mA output
- * Current Limiting
- * Power-Saving Shutdown Mode

REF.	Millimeter		REF.	Millimeter	
	Min.	Max.		Min.	Max.
A	4.40	4.80	c2	1.25	1.45
b	0.66	0.91	L2	1.27	REF.
L4	0.00	0.30		8.6	9.0
c	0.36	0.5	e	1.70	REF.
L1	2.29	2.79	L	14.6	15.8
E	9.80	10.4	θ	0°	8°

Applications

- * PC Peripherals
- * Wireless Devices
- * Portable Electronics
- * Battery Powered Widgets
- * Instrumentation

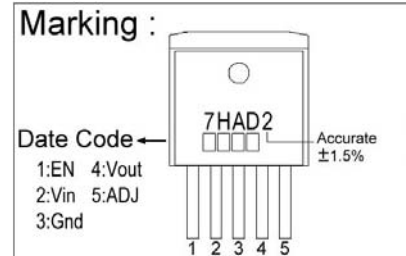

Functional Block Diagram

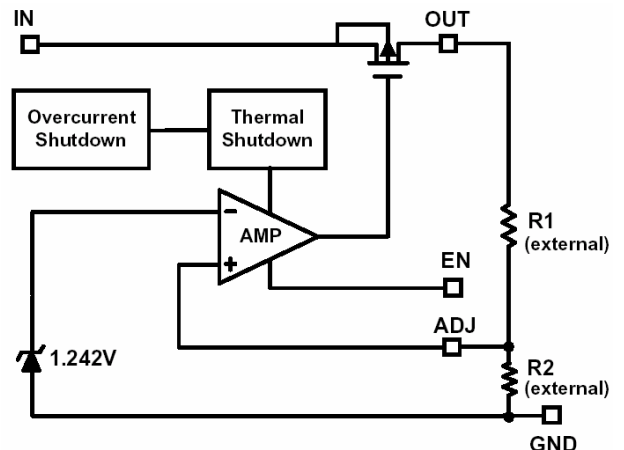

Typical Application Circuit

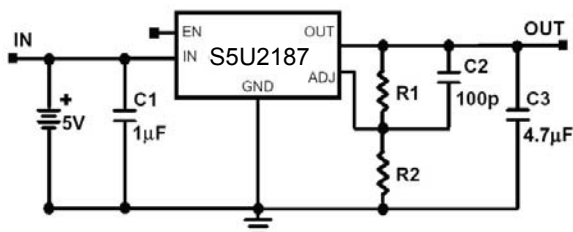

Absolute Maximum Ratings

Parameter	Symbol	Ratings	Unit
Input Voltage	V_{IN}	8	V
Output Current	I_{OUT}	$P_D/(V_{IN}-V_O)$	mA
Output Voltage	V_{OUT}	$Gnd-0.3 \sim V_{IN}+0.3$	V
Operating Ambient Temperature	T_{opr}	-40~+85	°C
Junction Temperature	T_j	-40~+125	°C
Max. Junction Temperature	$T_j \text{ Max.}$	150	°C
Power Dissipation ($\Delta T=100^\circ\text{C}$)	P_D	3.0	W
EDS Classification		B	

Electrical Characteristics $T_A=25^\circ\text{C}$ unless otherwise noted

($V_{IN}=V_{OUT}(T) + 2V$, $V_{EN}=V_{IN}$, $C_{IN}=1\mu\text{F}$, $C_{OUT}=4.7\mu\text{F}$)

Parameter	Symbol	Condition	Min	TYP	Max	Unit	
Output Voltage	$V_{OUT}(E)$ (Note1)	$I_O=1\text{mA}$, $V_{IN}=V_{OUT}(T)+2V$	-1.5	$V_{OUT}(T)$ (Note2)	1.5	%	
Output Current	I_O	$V_O>1.2V$	750	-	-	mA	
Current Limit	I_{LIM}	$V_O>1.2V$	750	-	-	mA	
Short Circuit Current	I_{SC}	$V_{IN}=V_{OUT}(T)+1V$, $V_O < 0.4V$	-	750	-	mA	
Load Regulation	REG_{LOAD}	$V_{IN}=V_{OUT}(T)+2V$, $I_O=1\text{mA}$ to 750mA	-1	0.2	1	%	
Dropout Voltage	$V_{DROPOUT}$	$I_O=750\text{mA}$ $V_O=V_{OUT}(E)-2\%$	$V_{OUT}(T)=1.5V$	-	-	1000	mV
			$V_{OUT}(T)=1.8V$	-	-	650	
			$V_{OUT}(T)\geq 2.0V$	-	-	500	
Quiescent Current	I_Q	$V_{IN}=V_{OUT}(T)+2V$, $I_O=0\text{mA}$	-	45	70	μA	
Ground Pin Current	I_{GND}	$V_{IN}=V_{OUT}(T)+2V$, $I_O=1\text{mA}$ to 750mA	-	45	-	μA	
Line Regulation	REG_{LINE}	$I_O=1\text{mA}$ $V_{IN}=V_{OUT}$ $V_{OUT}(T)+2$	$V_{OUT}(T)<2.0V$	-0.15	-	0.15	%
			$2.0V\leq V_{OUT}(T)<4.0V$	-0.1	0.02	0.1	
			$4.0V\leq V_{OUT}(T)$	-0.4	-	0.4	
Input Voltage	V_{IN}		Note3	-	7	V	
Over Temperature Shutdown	OTS		-	150	-	°C	
Over Temperature Hysteresis	OTH		-	30	-	°C	
Output Voltage Temperature Coefficient	TC		-	30	-	ppm/°C	
ADJ Input Bias Current	I_{ADJ}		-	1	-	μA	
Minimum Load Current	I_{Load}	$V_{IN}=2.5V$	-	-	70	μA	
ADJ Reference Voltage	V_{REF}		1.221	1.240	1.26	V	
Power Supply Rejection	PSRR	$I_O=100\text{mA}$ $C_O=4.7\mu\text{F}$ (ceramic)	$f=1\text{kHz}$	-	75	-	dB
			$f=10\text{kHz}$	-	55	-	
			$f=100\text{kHz}$	-	30	-	
Output Voltage Noise	eN	$f=10\text{Hz}\sim 100\text{kHz}$, $I_O=10\text{mA}$, $C_O=4.7\mu\text{F}$	-	30	-	μVrms	
EN Input Threshold	V_{EH}	$V_{IN}=2.7V$ to 7V	2.0	-	V_{IN}	V	
	V_{EL}	$V_{IN}=2.7V$ to 7V	0	-	0.4	V	
EN Input Bias Current	I_{EH}	$V_{EN}=V_{IN}$, $V_{IN}=2.7V$ to 7V	-	-	1	μA	
	I_{EL}	$V_{EN}=0V$, $V_{IN}=2.7V$ to 7V	-	-	1	μA	
Shutdown Supply Current	I_{SD}	$V_{IN}=5V$, $V_O=0V$, $V_{EN}<V_{EL}$	-	0.5	2	μA	

Note 1: $V_{OUT}(E)$ =Effective Output Voltage (i.e. the output voltage when " $V_{OUT}(T) + 2.0V$ " is provided at the V_{IN} pin while maintaining a certain I_{OUT} value).

2: $V_{OUT}(T)$ =Specified Output Voltage

3: $V_{IN}(MIN)$ = $V_{OUT}+V_{DROPOUT}$



Elektronische Bauelemente

S5U2187

750mA CMOS

Positive Voltage Regulator

Ordering Information(contd.)

Part Number	Marking	Output Voltage	Part Number	Marking	Output Voltage
S5U2187-AD	7HAD2 XXXX	Adjustable			

Detailed Description

The S5U2187 of COMS regulator contains a PMOS pass transistor, voltage reference, error amplifier, over-current protection, and thermal shutdown.

The P-channel pass transistor receives data from the error amplifier, over-current shutdown, and thermal protection circuits. During normal operation, the error amplifier compares the output voltage to a precision reference. Over-current and Thermal shutdown circuits become active when the junction temperature exceeds 140°C, or the current exceeds 2.2A. During thermal shutdown, the output voltage remains low. Normal operation is restored when the junction temperature drops below 120°C.

The S5U2187 behaves like a current source when the load reaches 2.2A. However, if the load impedance drops below 0.3ohms, the current drops back to 600mA to prevent excessive power dissipation. Normal operation is restored when the load resistance exceeds 0.75ohms.

External Capacitors

The S5U2187 is stable with an output capacitance to ground of 4.7µF or greater. Ceramic capacitors have the lowest ESR, and will offer the best AC performance. Conversely, Aluminum Electrolytic capacitors exhibit the highest ESR, resulting in the poorest AC response. Unfortunately, large value ceramic capacitors are comparatively expensive. One option is to parallel a 0.1µF ceramic capacitor with a 10uF Aluminum Electrolytic. The benefit is low ESR, high capacitance, and low overall cost.

A second capacitor is recommended between the input and ground to stabilize VIN. The input capacitor should be at least 0.1µF to have a beneficial effect.

All capacitors should be placed in close proximity to the pins. A "Quiet" ground termination is desirable. This can be achieved with a "Star" connection.

Enable

When EN pin is pulled low, the PMOS pass transistor shuts off, and all internal circuits are powered down. In this state, the quiescent current is less than 2µA. This pin behaves much like an electronic switch.

100KΩ resistor is necessary between VEN source and EN pin when VEN is high than VIN.

(Note: There is no internal pull-up for EN pin. It can not be floating.)

Adjustable Version

The adjustable version uses external feedback resistors to generate an output voltage anywhere from 1.5V to 5.0V. Vadj is trimmed to 1.24V and Vout is given by the equation:

$$V_{OUT}=V_{adj} * (1+R1/R2)$$

Feedback resistors R1 and R2 should be high enough to keep quiescent current low, but increasing R1+R2 will reduce stability. In general, R1 and R2 in the 10's of kΩ will produce adequate stability, given reasonable layout precautions. To improve stability characteristics, keep parasitic on the ADJ pin to minimum, and lower R1 and R2 values.

Characteristics Curve

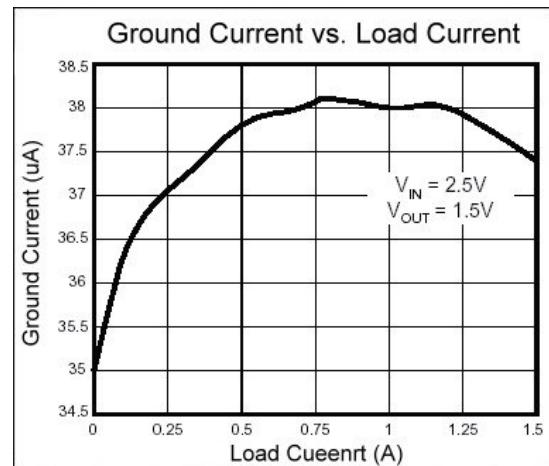
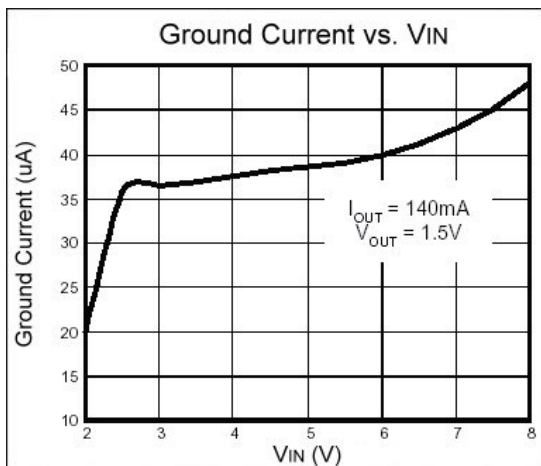
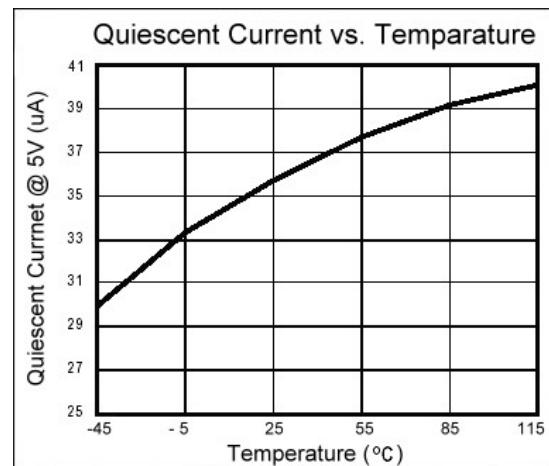
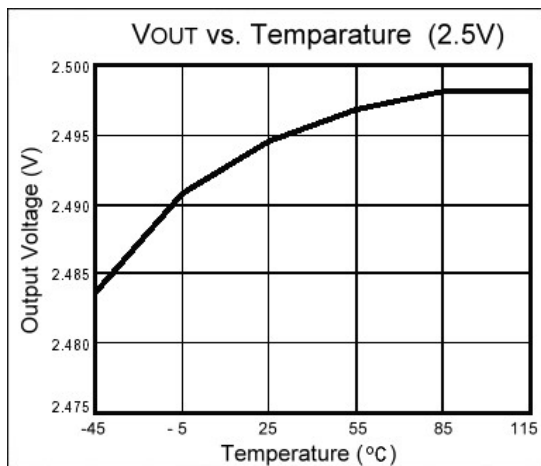
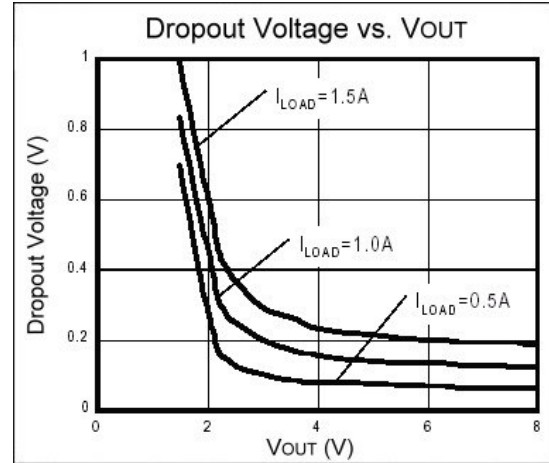
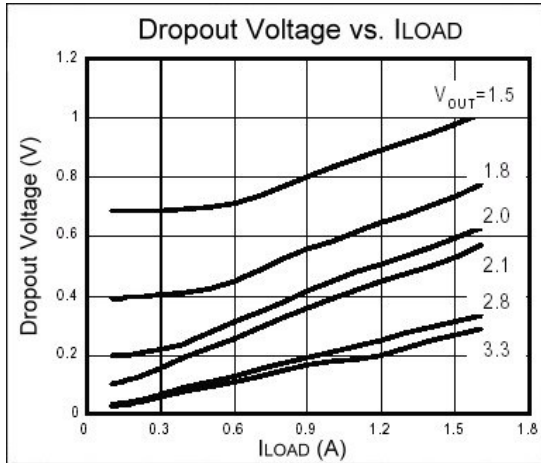

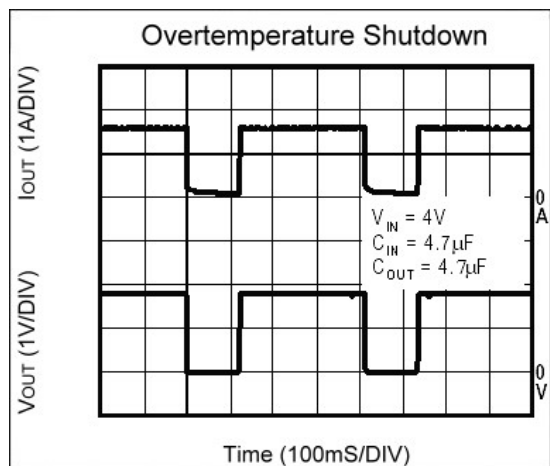
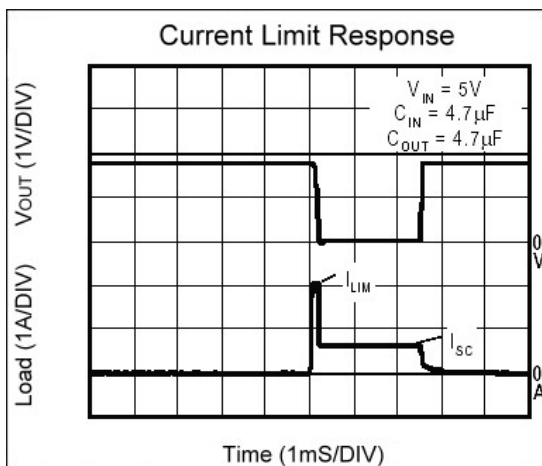
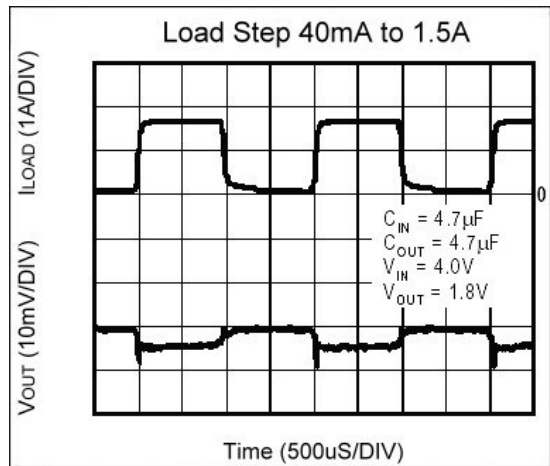
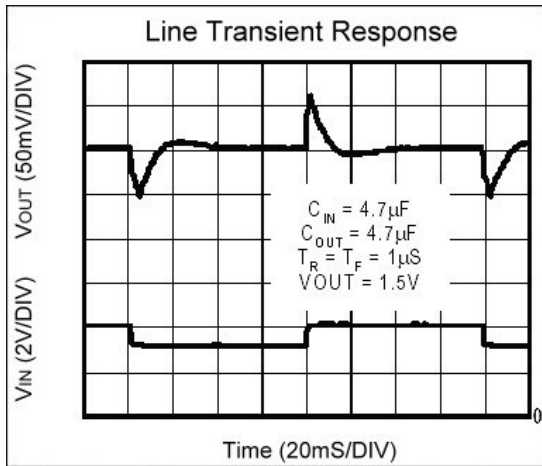
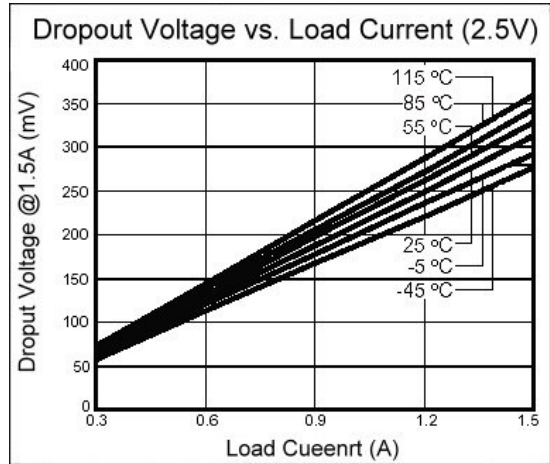
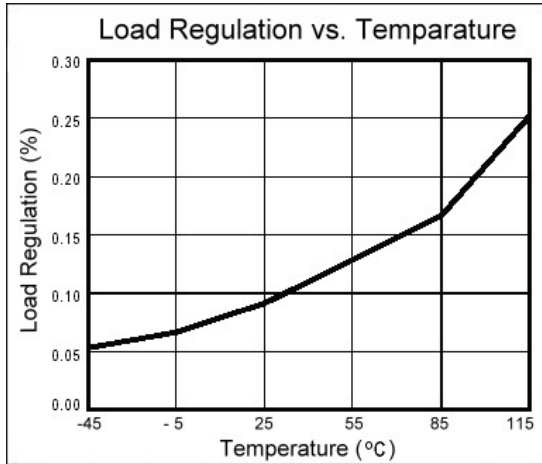

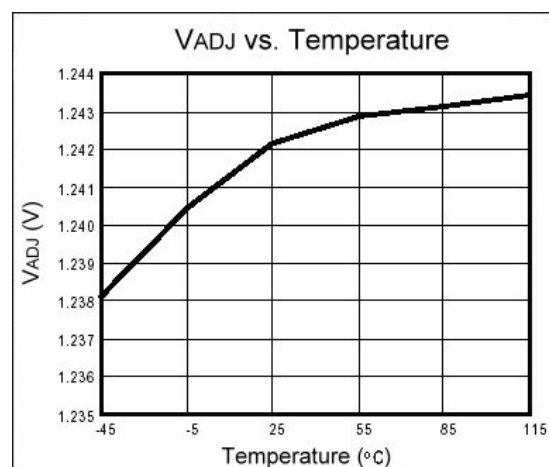
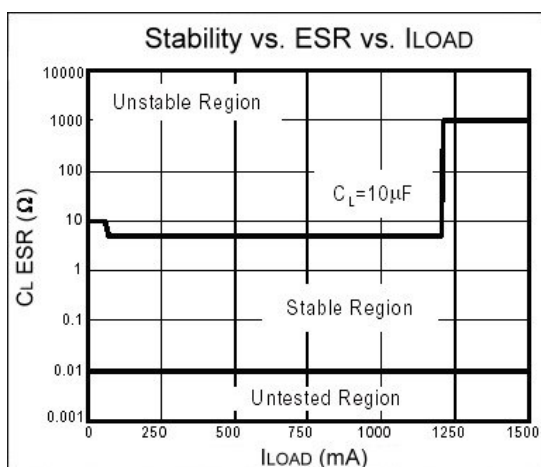
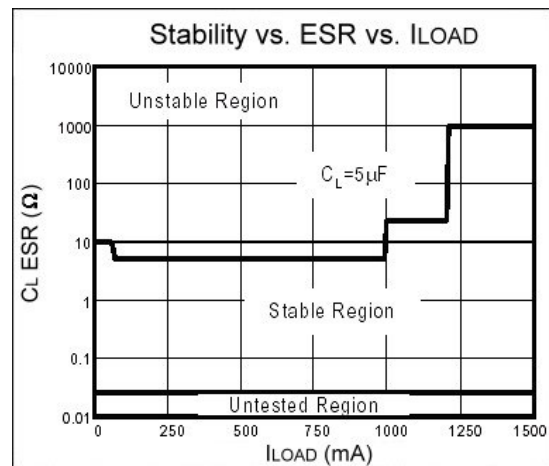
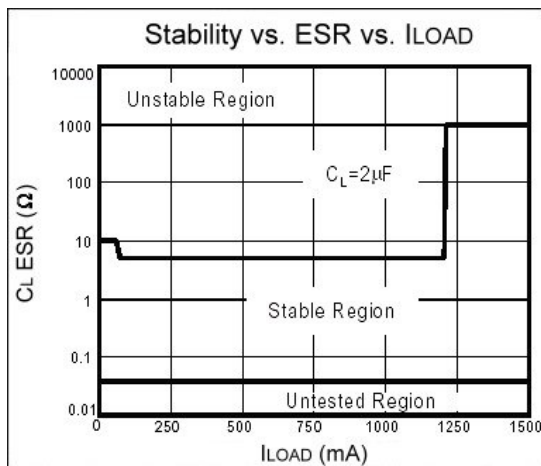
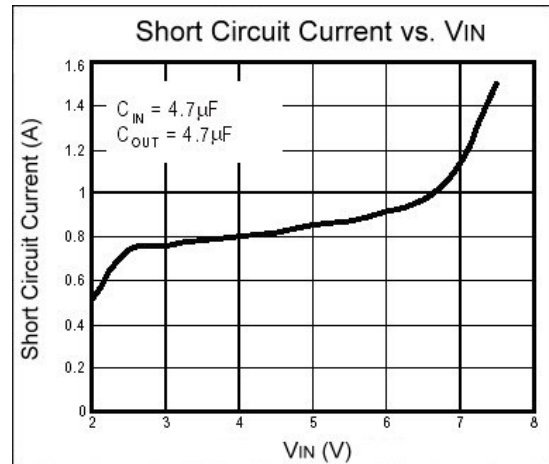
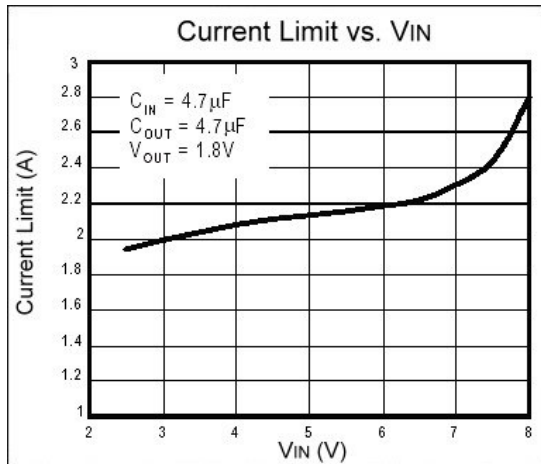



Elektronische Bauelemente

S5U2187

750mA CMOS

Positive Voltage Regulator

External Resistor Divider Table

R1(kΩ)	1	2	5	10	20
VOUT	$R2(k\Omega)=(1.24*R1(k\Omega))/(VOUT-1.24)$				
1.30	20.67	41.33	103.33	206.67	413.33
1.35	11.27	22.55	56.36	112.73	225.45
1.40	7.75	15.50	38.75	77.50	155.00
1.45	5.90	11.81	29.52	59.05	118.10
1.50	4.77	9.54	23.85	47.69	95.38
1.55	4.00	8.00	20.00	40.00	80.00
1.60	3.44	6.89	17.22	34.44	68.89
1.65	3.02	6.05	15.12	30.24	60.49
1.70	2.7	5.39	13.48	26.96	53.91
1.75	2.43	4.86	12.16	24.31	48.63
1.80	2.21	4.43	11.07	22.14	44.29
1.85	2.03	4.07	10.16	20.33	40.66
1.90	1.88	3.76	9.39	18.79	37.58
1.95	1.75	3.49	8.73	17.46	34.93
2.00	1.63	3.26	8.16	16.32	32.63
2.05	1.53	3.06	7.65	15.31	30.62
2.10	1.44	2.88	7.21	14.42	28.84
2.15	1.36	2.73	6.81	13.63	27.25
2.20	1.29	2.58	6.46	12.92	25.83
2.25	1.23	2.46	6.14	12.28	24.55
2.30	1.17	2.34	5.85	11.70	23.40
2.35	1.12	2.23	5.59	11.17	22.34
2.40	1.07	2.14	5.34	10.69	21.38
2.45	1.02	2.05	5.12	10.25	20.50
2.50	0.98	1.97	4.92	9.84	19.68
2.55	0.95	1.89	4.73	9.47	18.93
2.60	0.91	1.82	4.56	9.12	18.24
2.65	0.88	1.76	4.40	8.79	17.59
2.70	0.85	1.70	4.25	8.49	16.99
2.75	0.82	1.64	4.11	8.21	16.42
2.80	0.79	1.59	3.97	7.95	15.90
2.85	0.77	1.54	3.85	7.70	15.40
2.90	0.75	1.49	3.73	7.47	14.94
2.95	0.73	1.45	3.63	7.25	14.50
3.00	0.70	1.41	3.52	7.05	14.09
3.05	0.69	1.37	3.43	6.85	13.70
3.10	0.67	1.33	3.33	6.67	13.33
3.15	0.65	1.30	3.25	6.49	12.98

R1(kΩ)	1	2	5	10	20
VOUT	$R2(k\Omega)=(1.242*R1(k\Omega))/(VOUT-1.242)$				
3.20	0.63	1.27	3.16	6.33	12.65
3.25	0.62	1.23	3.08	6.17	12.34
3.30	0.60	1.20	3.01	6.02	12.04
3.35	0.59	1.18	2.94	5.88	11.75
3.40	0.57	1.15	2.87	5.74	11.48
3.45	0.56	1.12	2.81	5.61	11.22
3.50	0.55	1.10	2.74	5.49	10.97
3.55	0.54	1.07	2.68	5.37	10.74
3.60	0.53	1.05	2.63	5.25	10.51
3.65	0.51	1.03	2.57	5.15	10.29
3.70	0.50	1.01	2.52	5.04	10.08
3.75	0.49	0.99	2.47	4.94	9.88
3.80	0.48	0.97	2.42	4.84	9.69
3.85	0.48	0.95	2.38	4.75	9.50
3.90	0.47	0.93	2.33	4.66	9.32
3.95	0.46	0.92	2.29	4.58	9.15
4.00	0.45	0.90	2.25	4.49	8.99
4.05	0.44	0.88	2.21	4.41	8.83
4.10	0.43	0.87	2.17	4.34	8.67
4.15	0.43	0.85	2.13	4.26	8.52
4.20	0.42	0.84	2.09	4.19	8.38
4.25	0.41	0.82	2.06	4.12	8.24
4.30	0.41	0.81	2.03	4.05	8.10
4.35	0.40	0.80	1.99	3.99	7.97
4.40	0.39	0.78	1.96	3.92	7.85
4.45	0.39	0.77	1.93	3.86	7.73
4.50	0.38	0.76	1.90	3.80	7.61
4.55	0.37	0.75	1.87	3.75	7.49
4.60	0.37	0.74	1.85	3.69	7.38
4.65	0.36	0.73	1.82	3.64	7.27
4.70	0.36	0.72	1.79	3.58	7.17
4.75	0.35	0.71	1.77	3.53	7.07
4.80	0.35	0.70	1.74	3.48	6.97
4.85	0.34	0.69	1.72	3.43	6.87
4.90	0.34	0.68	1.69	3.39	6.78
4.95	0.33	0.67	1.67	3.34	6.68
5.00	0.33	0.66	1.65	3.30	6.60

Note: Small load (greater than 2mA) is necessary as R1 or R2 is larger than 50kΩ. Otherwise, output voltage probably can not be pulled down to 0V on disable mode.