

AC Semiconductor Contactor
pitch 45mm
compact size and DIN rail mounting.

SIB865170

Output : 24-510VAC 2x22A(*)
2 Inputs : 3,5-32VDC / I<10mA



- ❑ Ready to use Two-Phase Relay: " Install it & Forget it!"
- ❑ Zero cross model : **24-510VAC 50A**
back to back thyristors on output -
TMS² technology - I^2t value > 1500A²s
- ❑ Large control range : **3,5-32VDC** with each input
current < 10 mA on all the range.
Green LED visualization on the input.
- ❑ Very high immunity : Voltage protection on output
and input- 4kV according IEC61000-4-4 & 5
- ❑ IP20 housing
- ❑ Low leakage current (<1mA) and low zero cross
voltage .
- ❑ Mounting and dismounting on DIN rail without any
tool or directly mountable on panel.
- ❑ Designed in conformity with EN60947-4-3
(IEC947-4-3) and EN60950
-UL-cUL



(*) see conditions (thermal curve page 3)

2 x18A

Dimensions :

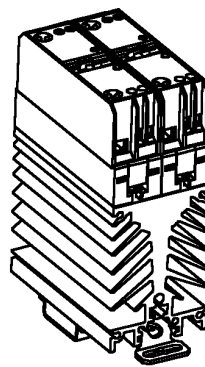
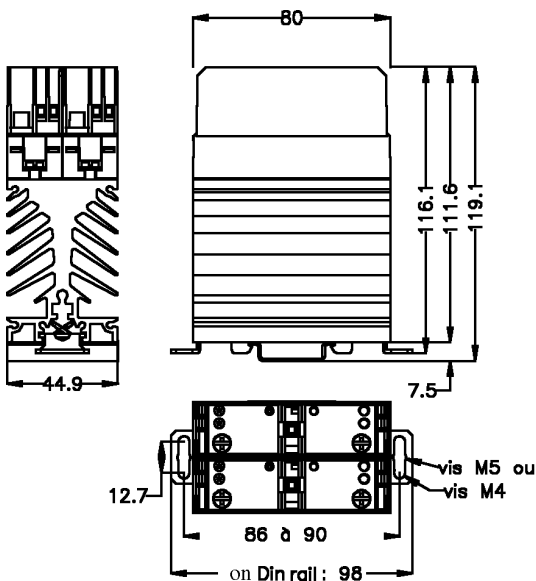

Typical application:
 12kW resistor
 (AC-51 load)
 on 400 VAC

The two input control can be mounted in parallel or in serie

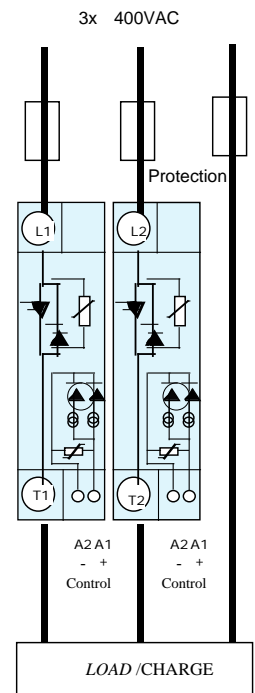

Proud to serve you

celduc®
 r e l a i s

Control characteristics (at 25°C)

Two inputs can be mounted in parallel or in serie

for each input :		DC			
Paramètre / Parameter	Symbol	Min	Nom	Max	Unit
Control voltage	Uc	3,5	5-12-24	32	V
Control current (@ Uc)	Ic	<10	<10	<10	mA
Release voltage	Uc off	2			V
Input LED		green			
Reverse voltage	Urv		32		V
Clamping voltage	Uclamp		42		V
Input immunity : EN61000-4-4			2kV		
Input immunity : EN61000-4-5			2KV		

Input : Ic = f(Uc)

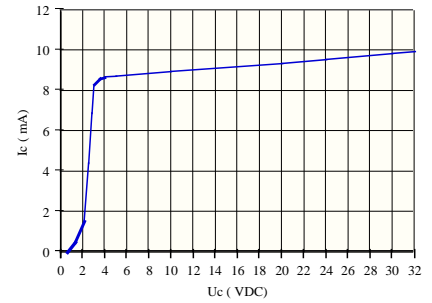

Output characteristics (at 20°C)

Parameter for each way	Conditions	Symbol	Typ.	Unit
Load voltage		Ue	400	V rms
Operating range		Uemin-max	24-510	V rms
Peak voltage		Up	1200	V
Clamping voltage		Uclamp	820 (@1mA)	V
Zero cross level		Usync	20	V
Latching voltage	Ie nom	Ua	8	V
AC-51 nominal current : permanent	(see Fig. 2 page 3)	Ie AC-51	2 x 22	A rms
AC-53 nominal current		Ie AC-53	2 x 12	A rms
Non repetitive overload current	tp=10ms (Fig. 3)	Itsm	550	A
On state voltage drop (typical value)	@ 25°C	Vt	0,9	V
Dynamic resistance (typical value)		rt	8	m
Output Power dissipation (typical value) : for each way (==> x2)		Pd	0,81xIe+0,08xIe ²	W
Thermal resistance between junction to air		Rthj/a	2,2 (1,8)	K/W
Off state leakage current	@Ue, 50Hz	Iik	<1	mA
Minimum load current		Iemin	5	mA
Turn on time	Uc nom DC ,f=50Hz	ton max	10	ms
Turn off time	Uc nom DC ,f=50Hz	toff max	10	ms
Operating frequency range		f	0,1-440	Hz
Off state dv/dt		dv/dt	500	V/µs
Maximum di/dt non repetitive		di/dt	50	A/µs
Izt (<10ms)		I ² t	1500	A ² s
Conducted immunity level	IEC 1000-4-4 (burst)		4kV criterion A	
Conducted immunity level	IEC 1000-4-5(schocks)		4kV criterion A	
Short circuit protection	FERRAZ		gRC 25A/32A/50A/63A 14x51	

General characteristics (at 20°C)

Input to output insulation	Ui	4000	VRMS
Output to case insulation	Ui	4000	VRMS
Insulation resistance	Ri	100 (@500VDC)	M
Rated impulse voltage	Uimp	4000	V
Protection level / CEI529	-	IP20	
Pollution degree	-	2	
Vibration resistance 10 -55 Hz according to CEI68 :	double amplitude	1,5	mm
Shocks resistance according to CEI68 (on DIN rail / with screws)	-	30/50	g
Ambient temperature (with no icing or condensation)	-	-30 /+80	°C
Storage temperature (with no icing or condensation)	-	-30/+100	°C
Ambient humidity	HR	40 to 85	%
Weight		450	g
Conformity		EN60947-4-3 (IEC947-4-3)	
Conformity		EN60950 UL/cUL pending	



ISO 9001
N° 1993/1106a

Thermal specifications .

Current according ambient temperature :

- **The curve "1"** gives the limits of the product. The temperature reached are acceptable for the components. These values are in compliance with most of SSRs manufacturers. In a cabinet with a minimum of ventilation or a non permanent current, these values are correct.
 - **The curve "2"** gives the limits of the product according to EN60947-4-3 with a maximum rise temperature of 50°C (@40°C) for a permanent working and in air calm (test during 8 hours).
 - For a non permanent current or a current inside only one way, you can calculate the average power = $P_d \times \text{duty cycle}$ and check the rise temperature : $\Delta T_j = P_d \times R_{thj/a}$ (P_d and $R_{thj/a}$ are given page 2)). The junction temperature must not exceed 125°C at the maximum ambient temperature.
- The maximum current is limited to the size of the thyristors = 50A.**
- The thermal constant (C_{th}) of the product is 7 minutes. That means the rise temperature is only 63% of the stabilized temperature after a running time of 7 minutes.

same current in 2 ways

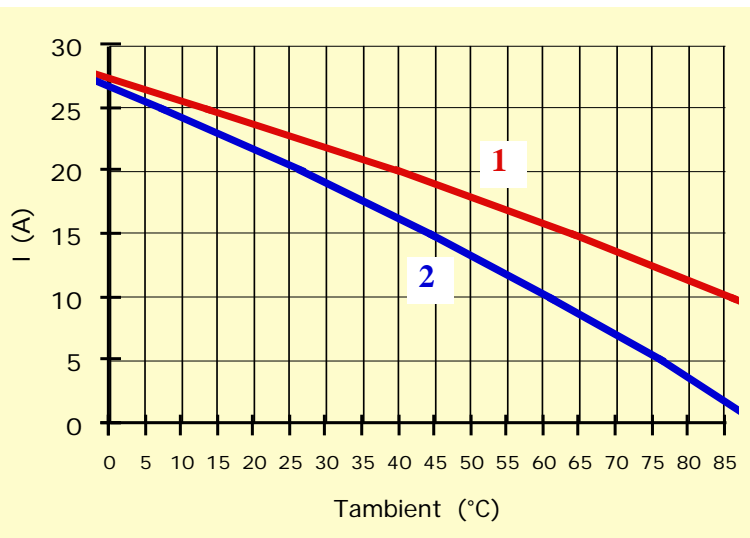

fig 2

Overload current .

1 - **No repetitive I_{tsm}** is given without voltage reappplied . This curve is used for the determination of the protection.

2 - **Repetitive I_{tsm}** is given for inrush current with initial $T_j = 70^\circ\text{C}$. In normal working , this curve musn't be exceed. Be carefull, the repetition of the surge current decrease the lifetime SSR's .

fig 3

Fig.3 Surge current : $I_{tsm} (A_{peak}) = f(t)$ for 50A models with $I_{tsm} = 550A$

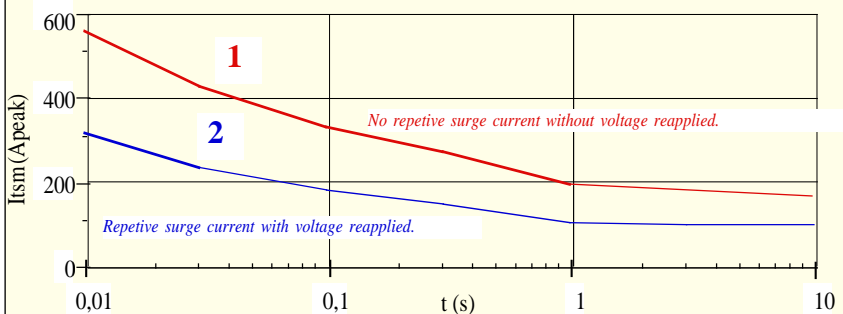

Mounting and dismounting on DIN rail without any tool.

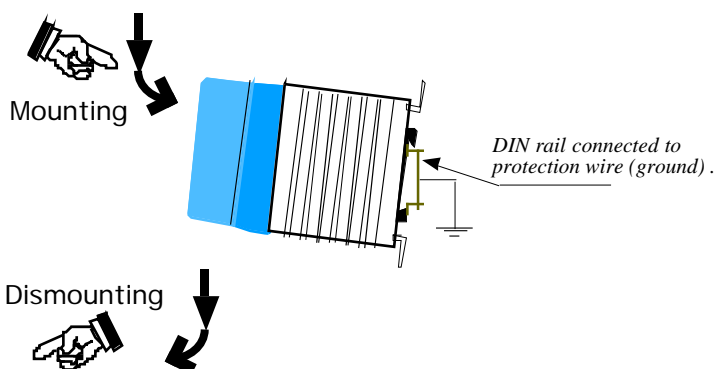

Panel Mounting

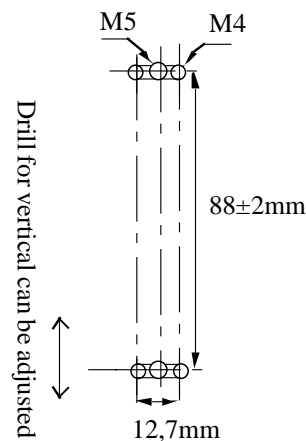

➤ **Warning !** semiconductor relays don't provide any galvanic insulation between the load and the mains. Always use in conjunction with an adapted circuit breaker with isolation feature or a similar device in order to ensure a reliable isolation in the event of wrong function and when the relay must be insulated from the mains (maintenance ; if not used for a long duration ...).



Connections .

➤ For the output terminals, the wire cross sections must be adapted to the load current and to the overcurrent protection device characteristics. The relay rated voltage must be adapted to the mains rated voltage.

➤ **celpac** use screw clamp connections.



wires (mm ²)	torques	screwdriver
control 1 x(0,75-->2,5) L = 6mm	0,4N.m (0,6N.m max)	3,5x0,5mm
Power 1x(1,5-->16) 1 x(1,5-->10) L = 10mm	1,2N.m (1,8N.m max)	Pozidriv2/ 0,8x5,5 (1x6)

Mounting

➤ **Warning :** only in vertical position. The user should protect heat sensitive materials as well as persons against any contacts with the heatsink. For non vertical mounting , the load current must be 50% lower than the rated one . For a good cooling, the SSR needs an air convection. Less convection air produces an abnormal heating. Keep a distance between the upper SSR and the lower SSR. In case of no space between two SSR (zero space between two SSRs) , please reduce the load current. For further details refer to below :

➤ **Derating current with no space between SSRs**

AC-51 nominal currents are given with a space of 22,5mm between each SSR, for a permanent current during a minimum time of 8 hours in air calm according to IEC60947-4-3. In case of non permanent currents or in case of SSRs are mounted with no space, you must check the heatsink temperature never exceed 90°C. When the SSRs are mounted side to side (no space between each relay) a derating current of 25% must be take into account. A forced cooling (fan inside the cabinet) improves significantly the thermal performances.

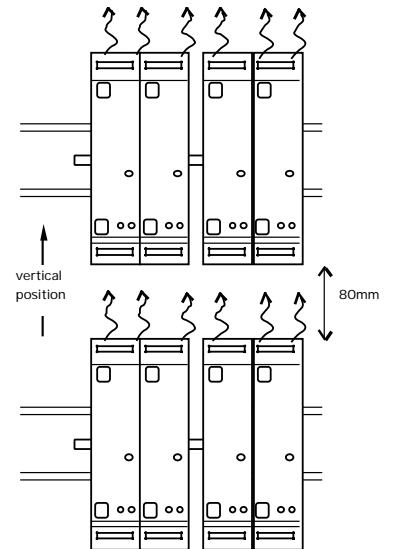

Typical application : LOADS

SIB product is designed mainly for AC-51 résistive load. AC-53 motor current are also given . For other loads, check the inrush current at turn ON and possible overvoltages at turn OFF or consult us :

- * AC-55b : Incandescent lamps : Inrush current is generally 10 times I_n during few 10ms. So limit the nominal current at about 15A.
- * AC-55a : Electric discharge lamp : These loads often have overcurrent at turn ON and overvoltage at turn OFF, so we advise to use 400VAC SSR on 230VAC mains.
- * AC-56a : Transformers loads : Very high inrush current up to 100 times I_n . We advise to use random SSR.
- * AC-56b : Capacitors loads : Very high current at turn ON and overvoltage at turn OFF, please consult us with 1600V peak SSR with high inrush current.

Protection :

To protect the SSR against a short-circuit of the load , use a fuse with a I^2t value = $1/2 I^2t$ value specified page 2. A test has been made with FERRAZ fuse (see page 2). It is possible to protect SSR by MCB (miniature circuit breaker). In this case, see application note (SSR protection) and use a SSR with high I^2t value (5000A²s minimum).

EMC :

➤ **Immunity :**
We give in our data-sheets, the immunity level of our SSRs according to the main standards for this type of products : EN61000-4-4 &5. You can see the high immunity level in comparison with the products on the market.

➤ **Emission:**
SSRs are complex devices which must be interconnected with other equipment (loads, cables,etc.) to form a system. Because the other equipment or the interconnections may not be under the control of **celduc**, it shall be the responsibility of the system integrator to ensure that systems containing SSRs comply with the requirements of any rules and regulations applicable at the system level. The very low zero cross voltage (<20V) improves the conducted emission level in comparison with most of SSR on the market with zero cross voltage higher than 50V. Consult **celduc** laboratory which can make some tests in your application.

