

Silicon NPN Power Transistors

2SC4164

DESCRIPTION

- With TO-220C package
- High voltage ,high speed
- Wide area of safe operation

APPLICATIONS

- For switching regulator applications

PINNING

PIN	DESCRIPTION
1	Base
2	Collector; connected to mounting base
3	Emitter

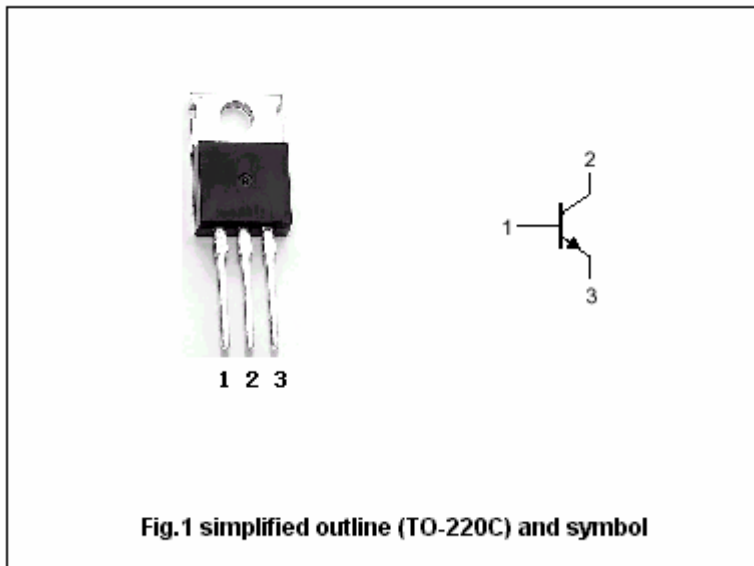
Absolute maximum ratings($T_a=25^\circ\text{C}$)

SYMBOL	PARAMETER	CONDITIONS	VALUE	UNIT
V_{CBO}	Collector-base voltage	Open emitter	500	V
V_{CEO}	Collector-emitter voltage	Open base	400	V
V_{EBO}	Emitter-base voltage	Open collector	7	V
I_C	Collector current		12	A
I_{CM}	Collector current-Peak	$P_w \leq 300\mu\text{s}$, duty cycle $\leq 10\%$	25	A
I_B	Base current		4	A
P_C	Collector dissipation	$T_a=25^\circ\text{C}$	1.75	W
		$T_C=25^\circ\text{C}$	70	
T_j	Junction temperature		150	$^\circ\text{C}$
T_{stg}	Storage temperature		-50~150	$^\circ\text{C}$

Silicon NPN Power Transistors

2SC4164

CHARACTERISTICS

T_j=25°C unless otherwise specified

SYMBOL	PARAMETER	CONDITIONS	MIN	TYP.	MAX	UNIT
V _{(BR)CEO}	Collector-emitter breakdown voltage	I _C =10mA ; R _{BE} =∞	400			V
V _{(BR)CBO}	Collector-base breakdown voltage	I _C =1mA ; I _E =0	500			V
V _{(BR)EBO}	Emitter-base breakdown voltage	I _E =1mA ; I _C =0	7			V
V _{CEsat}	Collector-emitter saturation voltage	I _C =8A ; I _B =1.6A			0.8	V
V _{BEsat}	Base-emitter saturation voltage	I _C =8A ; I _B =1.6A			1.5	V
I _{CBO}	Collector cut-off current	V _{CB} =400V ; I _E =0			10	μA
I _{EBO}	Emitter cut-off current	V _{EB} =5V ; I _C =0			10	μA
h _{FE-1}	DC current gain	I _C =1.6A ; V _{CE} =5V	15		50	
h _{FE-2}	DC current gain	I _C =8A ; V _{CE} =5V	10			
h _{FE-3}	DC current gain	I _C =10mA ; V _{CE} =5V	10			
f _T	Transition frequency	I _C =1.6A ; V _{CE} =10V		20		MHz
C _{ob}	Collector output capacitance	f=1MHz ; V _{CB} =10V		160		pF

Switching times

t _{on}	Turn-on time	I _C =10A ; I _{B1} =2A I _{B2} =-4A ; V _{CC} =200V R _L =20Ω			0.5	μs
t _s	Storage time				2.5	μs
t _f	Fall time				0.3	μs

◆ h_{FE-1} Classifications

L	M	N
15-30	20-40	30-50

PACKAGE OUTLINE

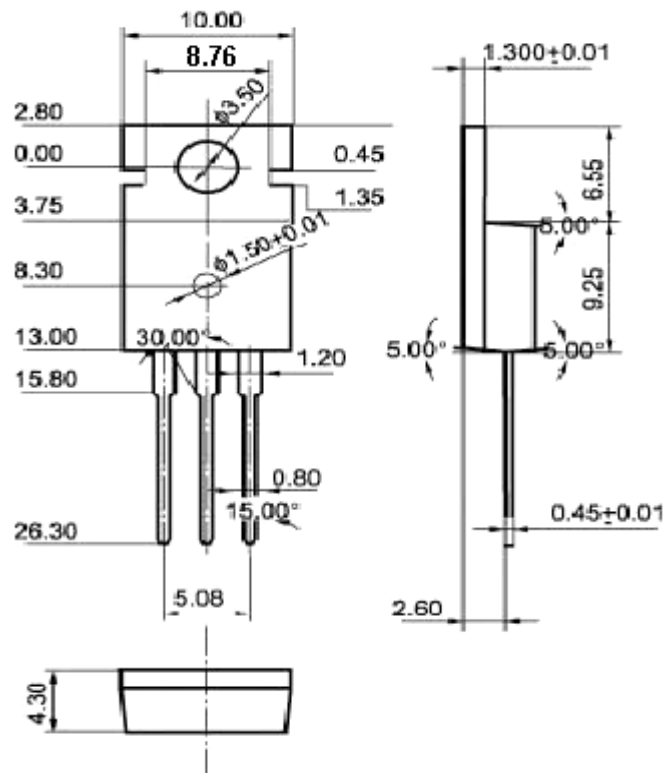

Fig.2 Outline dimensions (unindicated tolerance:±0.10 mm)

Silicon NPN Power Transistors

2SC4164

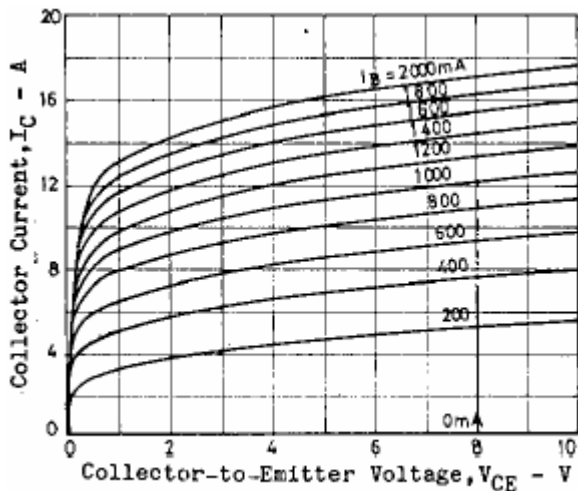

Fig.3 Static Characteristic

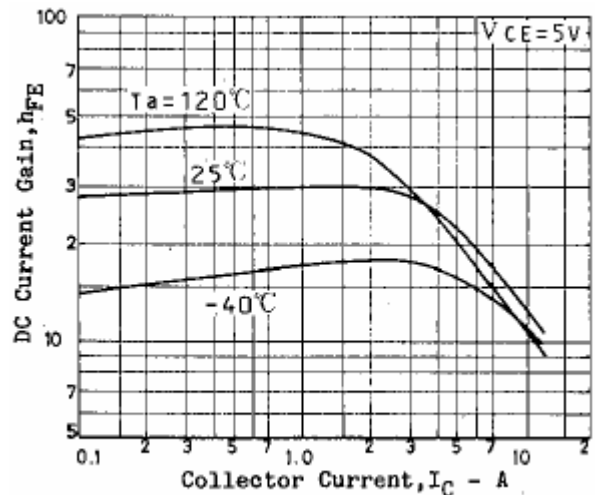

Fig.4 DC current Gain

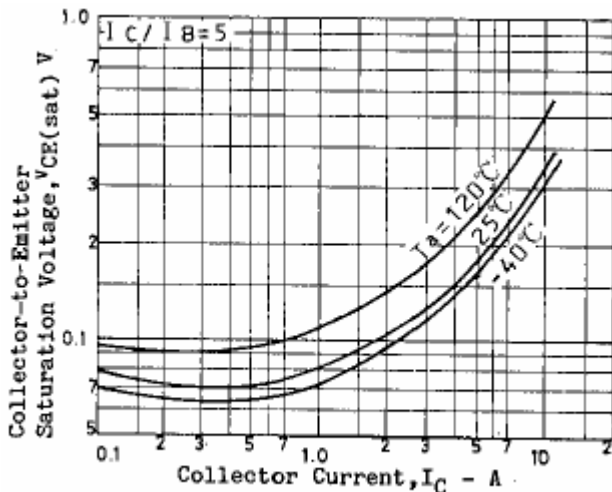

Fig.5 Collector-Emmitter Saturation Voltage

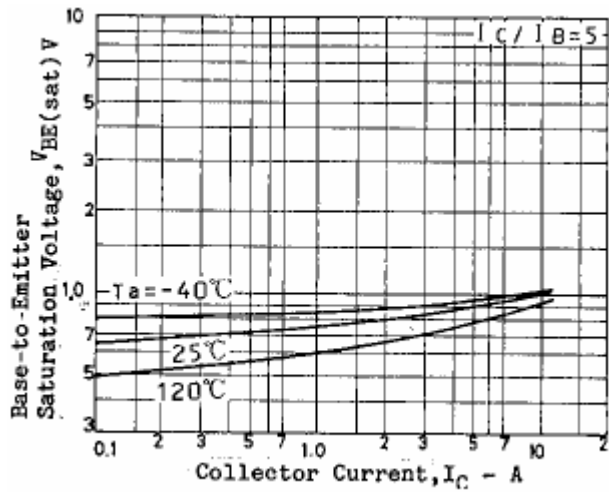

Fig.6 Base-Emmitter Saturation Voltage

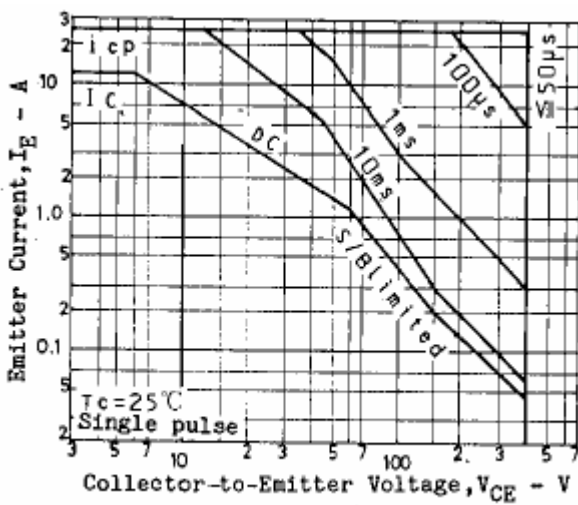

Fig.7 Safe Operating Area