

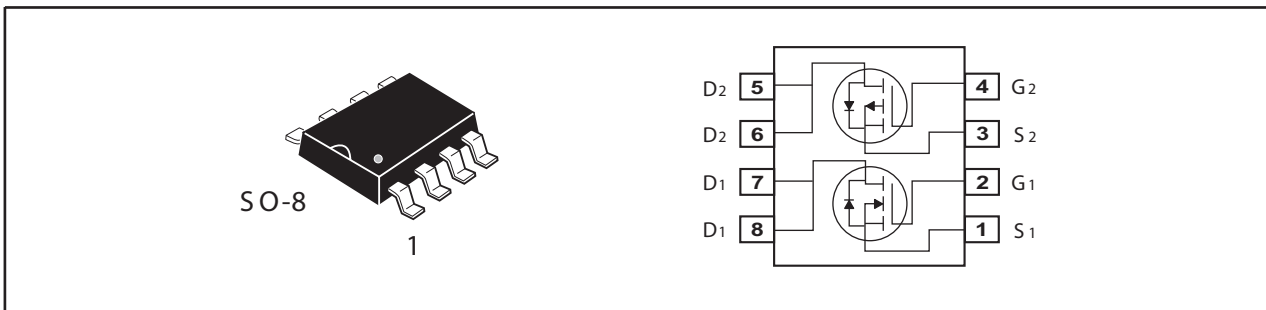

Dual Enhancement Mode Field Effect Transistor (N and P Channel)

PRODUCT SUMMARY (N-Channel)		
V _{DSS}	I _D	R _{DS(ON)} (mΩ) Max
60V	4.5A	58 @ V _{GS} =10V
		75 @ V _{GS} =4.5V

PRODUCT SUMMARY (P-Channel)		
V _{DSS}	I _D	R _{DS(ON)} (mΩ) Max
-60V	-3.3A	105 @ V _{GS} =-10V
		150 @ V _{GS} =-4.5V



ABSOLUTE MAXIMUM RATINGS (T_A=25°C unless otherwise noted)

Symbol	Parameter	N-Channel	P-Channel	Units	
V _{DS}	Drain-Source Voltage	60	-60	V	
V _{GS}	Gate-Source Voltage	±20	±20	V	
I _D	Drain Current-Continuous ^a	T _A =25°C	4.5	-3.3	A
		T _A =70°C	3.6	-2.6	A
I _{DM}	-Pulsed ^b	16	12	A	
E _{AS}	Single Pulse Avalanche Energy ^d	15	20	mJ	
P _D	Maximum Power Dissipation ^a	T _A =25°C	2.0	W	
		T _A =70°C	1.28	W	
T _J , T _{STG}	Operating Junction and Storage Temperature Range	-55 to 150		°C	

THERMAL CHARACTERISTICS

R _{θJA}	Thermal Resistance, Junction-to-Ambient ^a	62.5	°C/W
------------------	--	------	------

N-Channel ELECTRICAL CHARACTERISTICS (TA=25°C unless otherwise noted)

Symbol	Parameter	Conditions	Min	Typ	Max	Units
OFF CHARACTERISTICS						
BV _{DSS}	Drain-Source Breakdown Voltage	V _{GS} =0V , I _D =250uA	60			V
I _{DSS}	Zero Gate Voltage Drain Current	V _{DS} =48V , V _{GS} =0V			1	uA
I _{GSS}	Gate-Body Leakage Current	V _{GS} = ±20V , V _{DS} =0V			±100	nA
ON CHARACTERISTICS						
V _{GS(th)}	Gate Threshold Voltage	V _{DS} =V _{GS} , I _D =250uA	1	1.9	3	V
R _{DS(ON)}	Drain-Source On-State Resistance	V _{GS} =10V , I _D =4.5A		48	58	m ohm
		V _{GS} =4.5V , I _D =4A		55	75	m ohm
g _{FS}	Forward Transconductance	V _{DS} =5V , I _D =4.5A		12		S
DYNAMIC CHARACTERISTICS ^c						
C _{ISS}	Input Capacitance	V _{DS} =30V, V _{GS} =0V f=1.0MHz		852		pF
C _{OSS}	Output Capacitance			72		pF
C _{RSS}	Reverse Transfer Capacitance			45		pF
SWITCHING CHARACTERISTICS ^c						
t _{D(ON)}	Turn-On Delay Time	V _{DD} =30V I _D =1A V _{GS} =10V R _{GEN} =3.3 ohm		12		ns
t _r	Rise Time			11		ns
t _{D(OFF)}	Turn-Off Delay Time			37.5		ns
t _f	Fall Time			8		ns
Q _g	Total Gate Charge	V _{DS} =30V, I _D =4.5A, V _{GS} =10V		14		nC
		V _{DS} =30V, I _D =4.5A, V _{GS} =4.5V		6.7		nC
Q _{gs}	Gate-Source Charge	V _{DS} =30V, I _D =4.5A,		1.75		nC
Q _{gd}	Gate-Drain Charge	V _{GS} =10V		2.9		nC
DRAIN-SOURCE DIODE CHARACTERISTICS						
I _S	Maximum Continuous Drain-Source Diode Forward Current				2	A
V _{SD}	Diode Forward Voltage ^b	V _{GS} =0V, I _S =2A		0.8	1.2	V

STM8601

Ver 1.0

P-Channel ELECTRICAL CHARACTERISTICS (TA=25°C unless otherwise noted)

Symbol	Parameter	Conditions	Min	Typ	Max	Units
OFF CHARACTERISTICS						
BV _{DSS}	Drain-Source Breakdown Voltage	V _{GS} =0V, I _D =-250uA	-60			V
I _{DSS}	Zero Gate Voltage Drain Current	V _{DS} =-48V, V _{GS} =0V			-1	uA
I _{GSS}	Gate-Body Leakage Current	V _{GS} = ±20V, V _{DS} =0V			±100	nA
ON CHARACTERISTICS						
V _{GS(th)}	Gate Threshold Voltage	V _{DS} =V _{GS} , I _D =-250uA	-1.0	-1.8	-3.0	V
R _{DS(ON)}	Drain-Source On-State Resistance	V _{GS} =-10V, I _D =-3.3A		85	105	m ohm
		V _{GS} =-4.5V, I _D =-2.8A		110	150	m ohm
g _{FS}	Forward Transconductance	V _{DS} =-5V, I _D =-3.3A		7		S
DYNAMIC CHARACTERISTICS °						
C _{ISS}	Input Capacitance	V _{DS} =-30V, V _{GS} =0V f=1.0MHz		730		pF
C _{OSS}	Output Capacitance			68		pF
C _{RSS}	Reverse Transfer Capacitance			43		pF
SWITCHING CHARACTERISTICS °						
t _{D(ON)}	Turn-On Delay Time	V _{DD} =-30V I _D =-1A V _{GS} =-10V R _{GEN} =3.3 ohm		12.4		ns
t _r	Rise Time			10.5		ns
t _{D(OFF)}	Turn-Off Delay Time			65		ns
t _f	Fall Time			23		ns
Q _g	Total Gate Charge	V _{DS} =-30V, I _D =-3.3A, V _{GS} =-10V		14		nC
		V _{DS} =-30V, I _D =-3.3A, V _{GS} =-4.5V		6.7		nC
Q _{gs}	Gate-Source Charge	V _{DS} =-30V, I _D =-3.3A,		1.5		nC
Q _{gd}	Gate-Drain Charge	V _{GS} =-30V		3.3		nC
DRAIN-SOURCE DIODE CHARACTERISTICS						
I _S	Maximum Continuous Drain-Source Diode Forward Current				-2	A
V _{SD}	Diode Forward Voltage ^b	V _{GS} =0V, I _S =-2A		-0.81	-1.2	V

Notes

- Surface Mounted on FR4 Board, t ≤ 10sec.
- Pulse Test: Pulse Width ≤ 300us, Duty Cycle ≤ 2%.
- Guaranteed by design, not subject to production testing.
- Starting T_J=25°C, L=0.5mH, V_{DD}=20V, V_{GS}=10V. (See Figure13)

Nov,06,2008

N-Channel

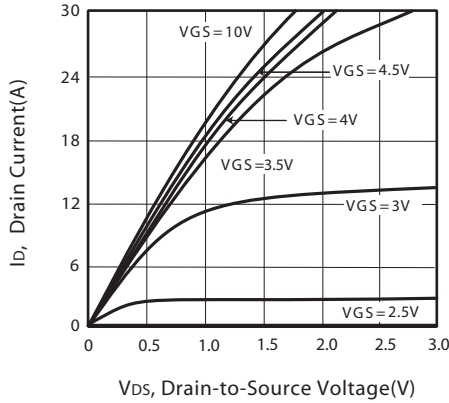

Figure 1. Output Characteristics

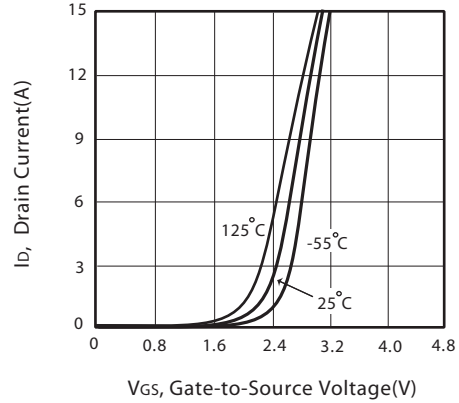

Figure 2. Transfer Characteristics

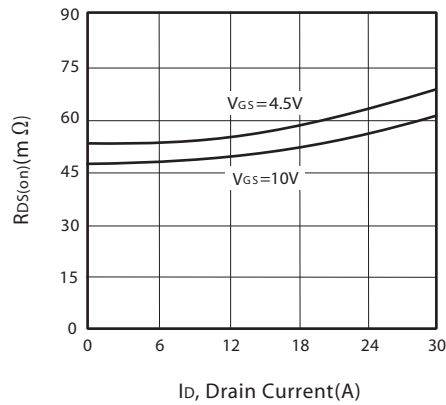

Figure 3. On-Resistance vs. Drain Current and Gate Voltage

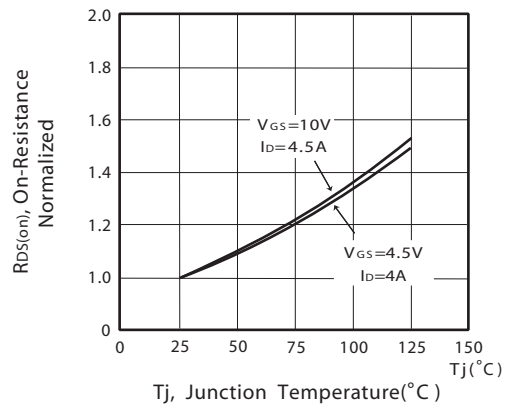

Figure 4. On-Resistance Variation with Drain Current and Temperature

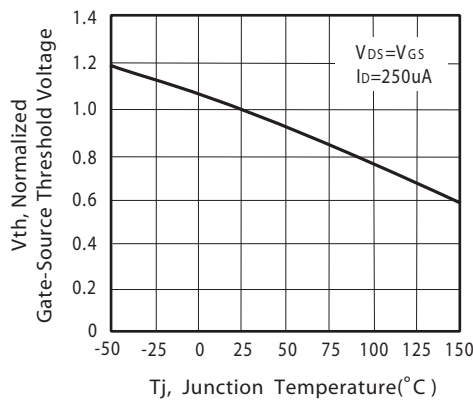

Figure 5. Gate Threshold Variation with Temperature

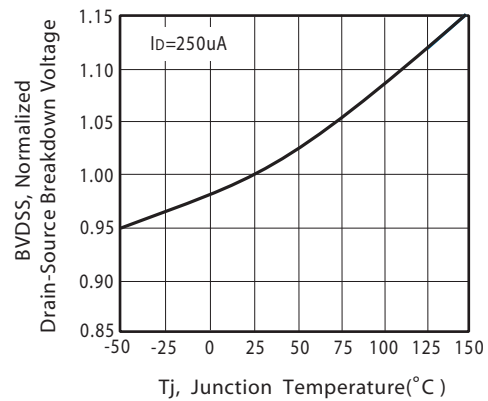

Figure 6. Breakdown Voltage Variation with Temperature

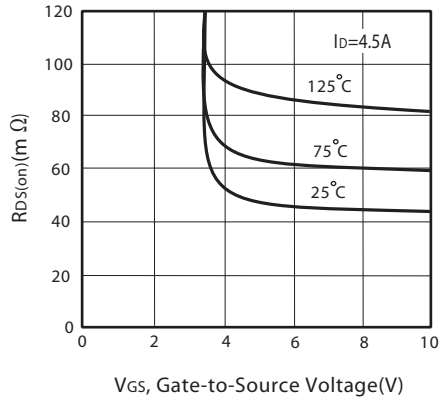

Figure 7. On-Resistance vs. Gate-Source Voltage

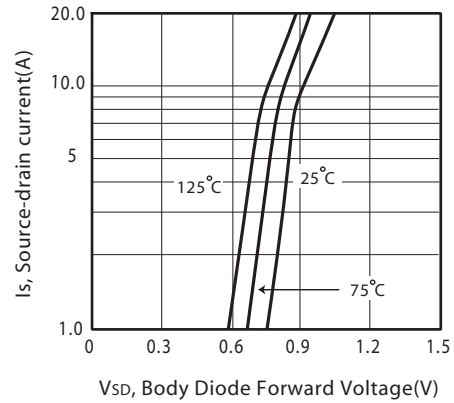

Figure 8. Body Diode Forward Voltage Variation with Source Current

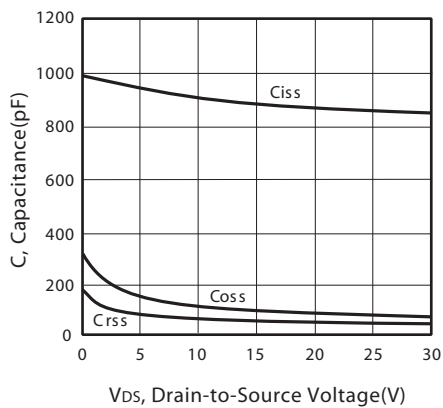

Figure 9. Capacitance

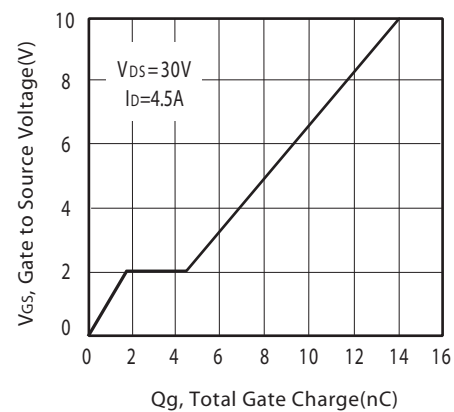

Figure 10. Gate Charge

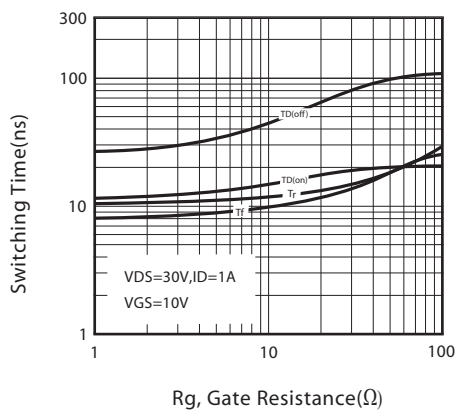

Figure 11. switching characteristics

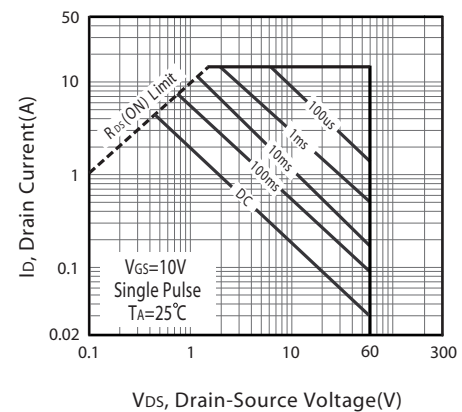
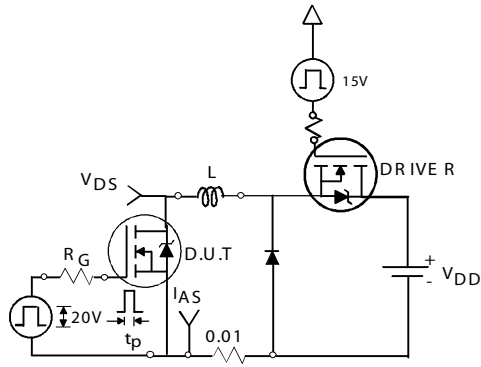
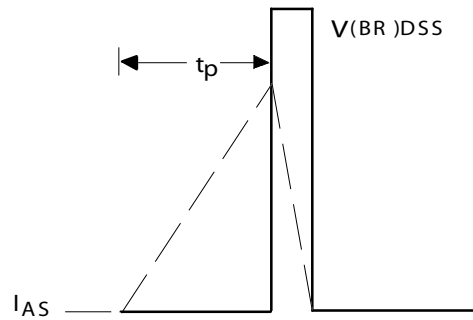

Figure 12. Maximum Safe Operating Area



Unclamped Inductive Test Circuit

Figure 13a.



Unclamped Inductive Waveforms

Figure 13b.

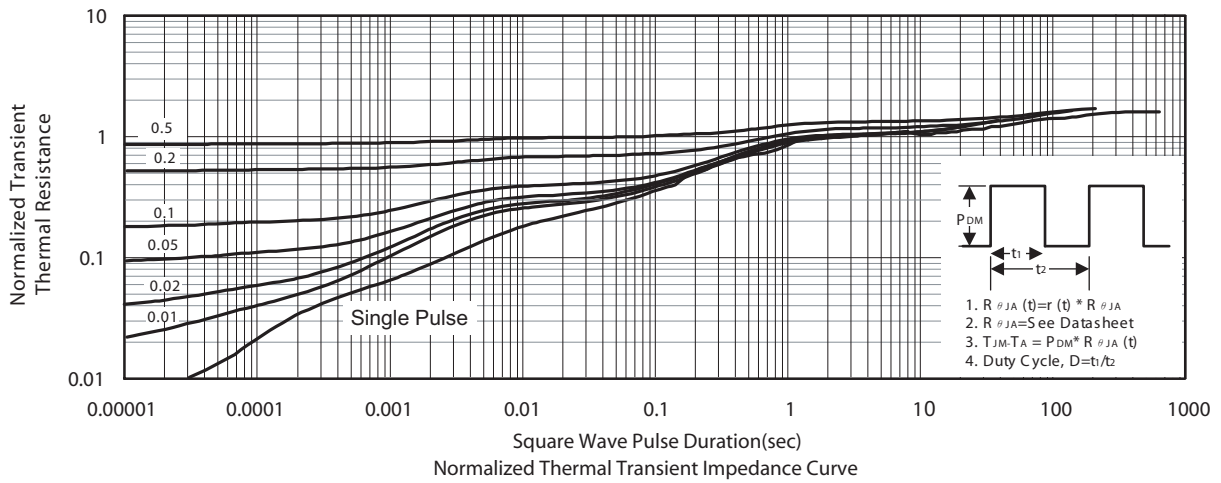

P-Channel

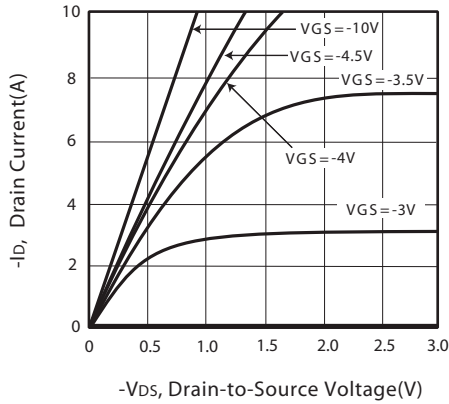

Figure 1. Output Characteristics

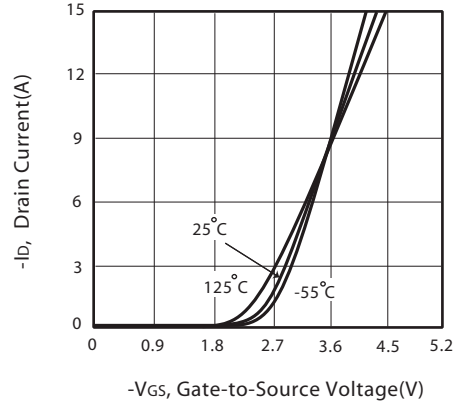

Figure 2. Transfer Characteristics

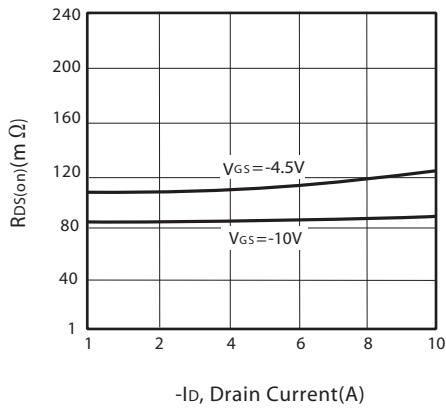

Figure 3. On-Resistance vs. Drain Current and Gate Voltage

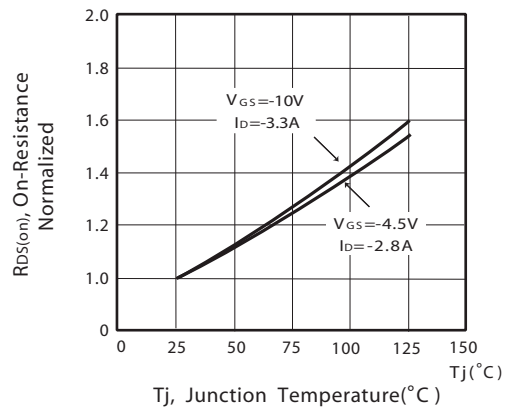

Figure 4. On-Resistance Variation with Drain Current and Temperature

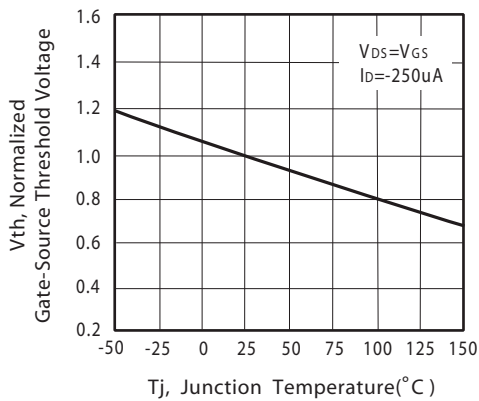

Figure 5. Gate Threshold Variation with Temperature

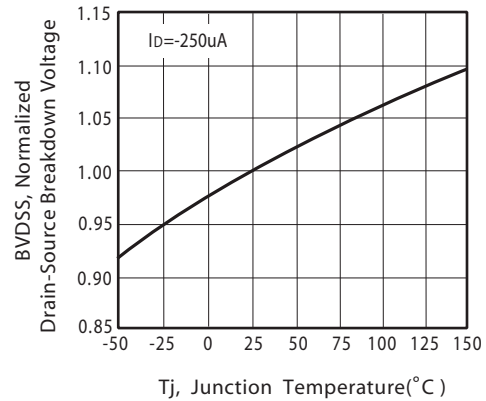

Figure 6. Breakdown Voltage Variation with Temperature

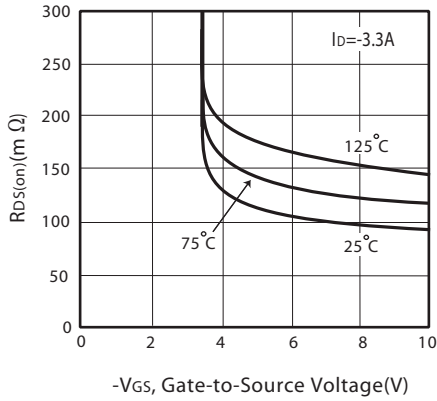

Figure 7. On-Resistance vs. Gate-Source Voltage

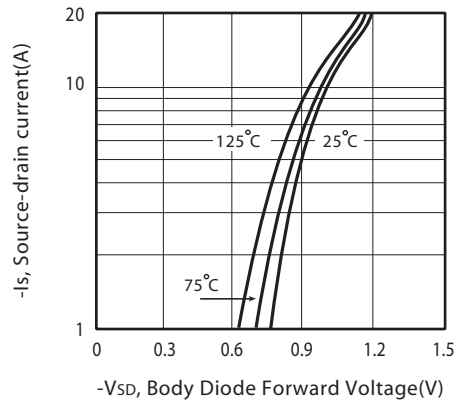

Figure 8. Body Diode Forward Voltage Variation with Source Current

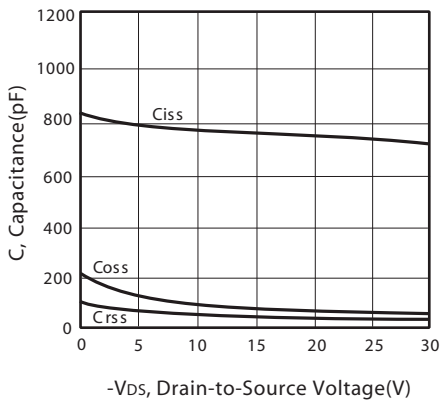

Figure 9. Capacitance

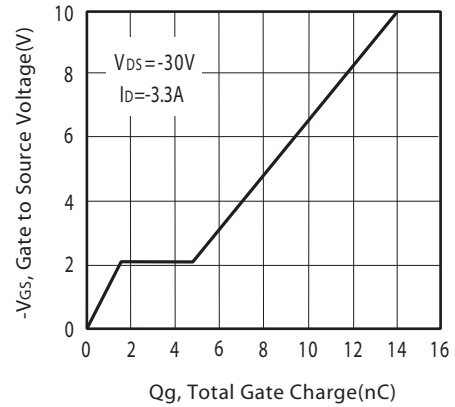

Figure 10. Gate Charge

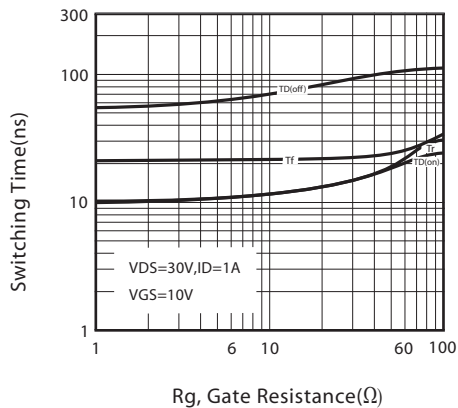

Figure 11. switching characteristics

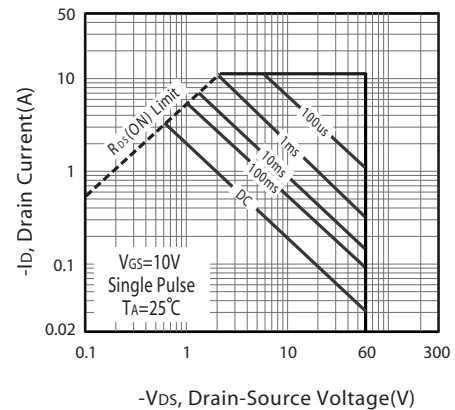
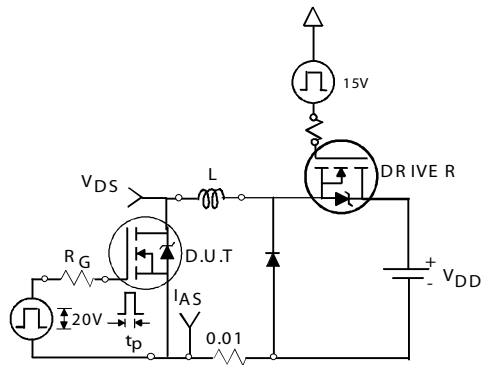
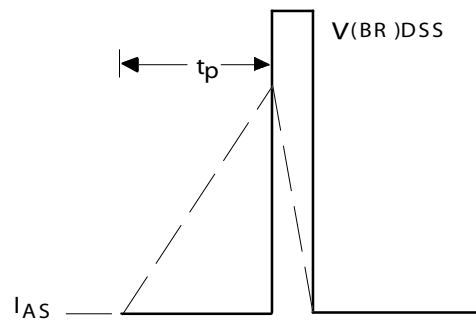

Figure 12. Maximum Safe Operating Area



Unclamped Inductive Test Circuit

Figure 13a.



Unclamped Inductive Waveforms

Figure 13b.

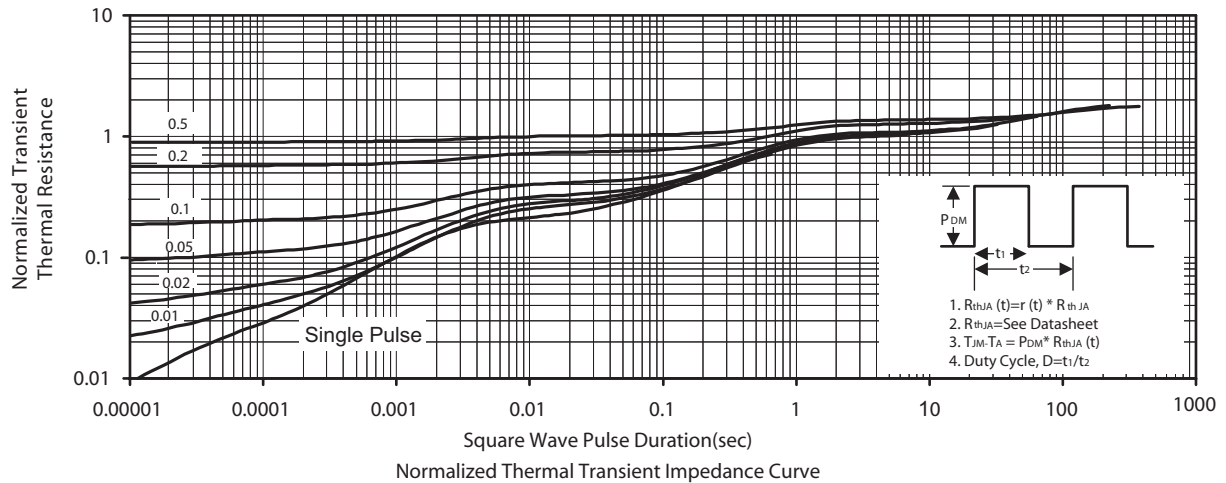

PACKAGE OUTLINE DIMENSIONS

SO-8

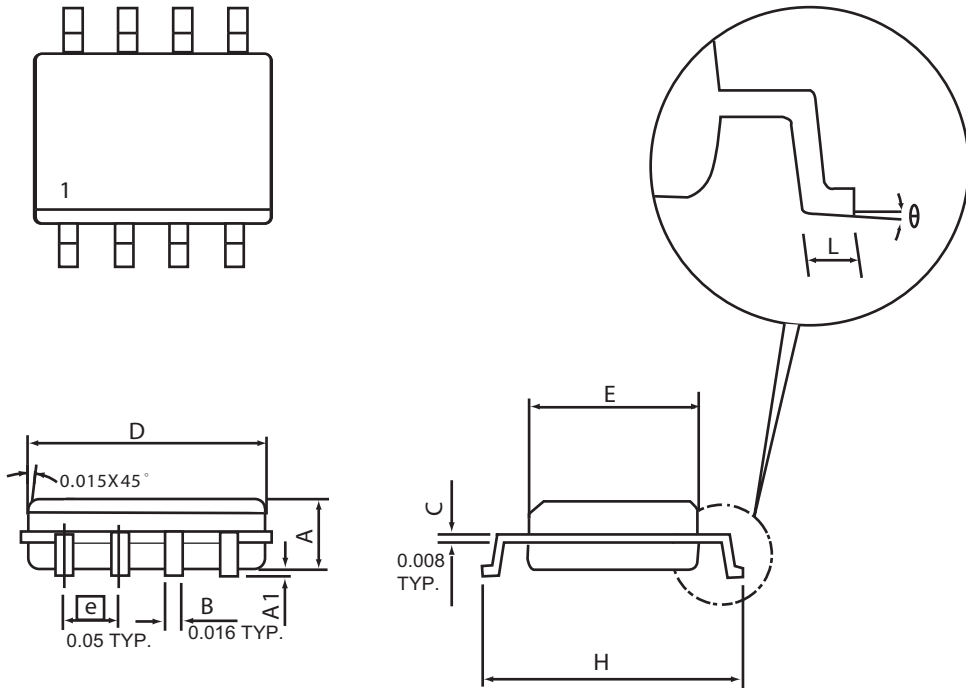

SYMBOLS	MILLIMETERS		INCHES	
	MIN	MAX	MIN	MAX
A	1.35	1.75	0.053	0.069
A1	0.10	0.25	0.004	0.010
D	4.80	4.98	0.189	0.196
E	3.81	3.99	0.150	0.157
H	5.79	6.20	0.228	0.244
L	0.41	1.27	0.016	0.050
θ	0°	8°	0°	8°

SO-8 Tape and Reel Data

SO-8 Carrier Tape

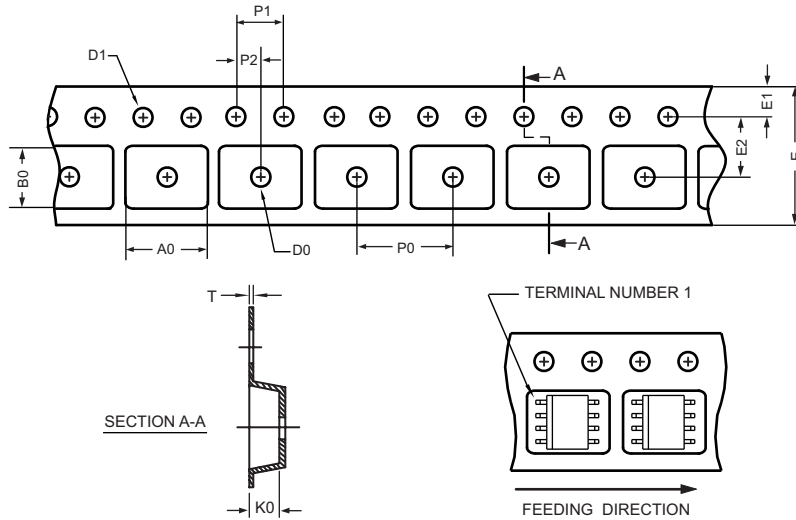

unit:mm

PACKAGE	A0	B0	K0	D0	D1	E	E1	E2	P0	P1	P2	T
SOP 8N 150mil	6.50 ±0.15	5.25 ±0.10	2.10 ±0.10	φ 1.5 (MIN)	φ 1.55 ±0.10	12.0 +0.3 - 0.1	1.75 ±0.10	5.5 ±0.10	8.0 ±0.10	4.0 ±0.10	2.0 ±0.10	0.30 ±0.013

SO-8 Reel

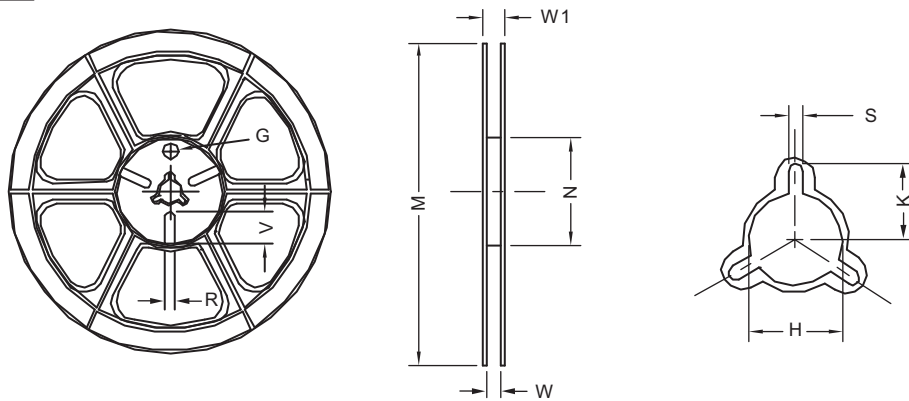

UNIT:mm

TAPE SIZE	REEL SIZE	M	N	W	W1	H	K	S	G	R	V
12 mm	φ 330	330 ± 1	62 ±1.5	12.4 + 0.2	16.8 - 0.4	φ 12.75 + 0.15	---	2.0 ±0.15	---	---	---