

# DATA SHEET

## **SMD common mode chokes EMI-suppression products**

Supersedes data of February 2002

2004 Sep 01

EMI-suppression products

SMD common mode chokes

**SMD COMMON MODE CHOKES FOR EMI-SUPPRESSION**

**General data**

ITEM	SPECIFICATION
Strip material	copper (Cu), tin-lead (SnPb) plated, lead-free (Sn) available on request.
Solderability	"IEC 60068-2-58", Part 2, Test Ta, method 1
Taping method	"IEC 60286-3", "EIA 481-1-A" and "EIA 481-2"

**Grades, parameters and type numbers**

GRADE	$ Z_{typ} ^{(1)}$ ( $\Omega$ )	at f (MHz)	TYPE NUMBER
<b>CMS2-5.6/3/4.8; mass <math>\approx</math>0.3 g</b>			
4S2	21	25	CMS2-5.6/3/4.8-4S2
	35	100	
	50	300	
<b>CMS2-5.6/3/8.9; mass <math>\approx</math>0.6 g</b>			
4S2	38	25	CMS2-5.6/3/8.9-4S2
	60	100	

GRADE	$ Z_{typ} ^{(1)}$ ( $\Omega$ )	at f (MHz)	TYPE NUMBER
<b>CMS4-11/3/4.8; mass <math>\approx</math>0.6 g</b>			
4S2 inner channel	12	25	CMS4-11/3/4.8-4S2
	23	100	
	42	300	
4S2 outer channel	15	25	
	30	100	
	50	300	
<b>CMS4-11/3/8.9; mass <math>\approx</math>1.1 g</b>			
4S2 inner channel	23	25	CMS4-11/3/8.9-4S2
	45	100	
	82	300	
4S2 outer channel	27	25	
	58	100	
	97	300	

**Note**

1. Typical values,  $|Z|_{min}$  is  $-20\%$ .  
DC resistance  $< 0.6 \text{ m}\Omega$ .

**Mechanical data**

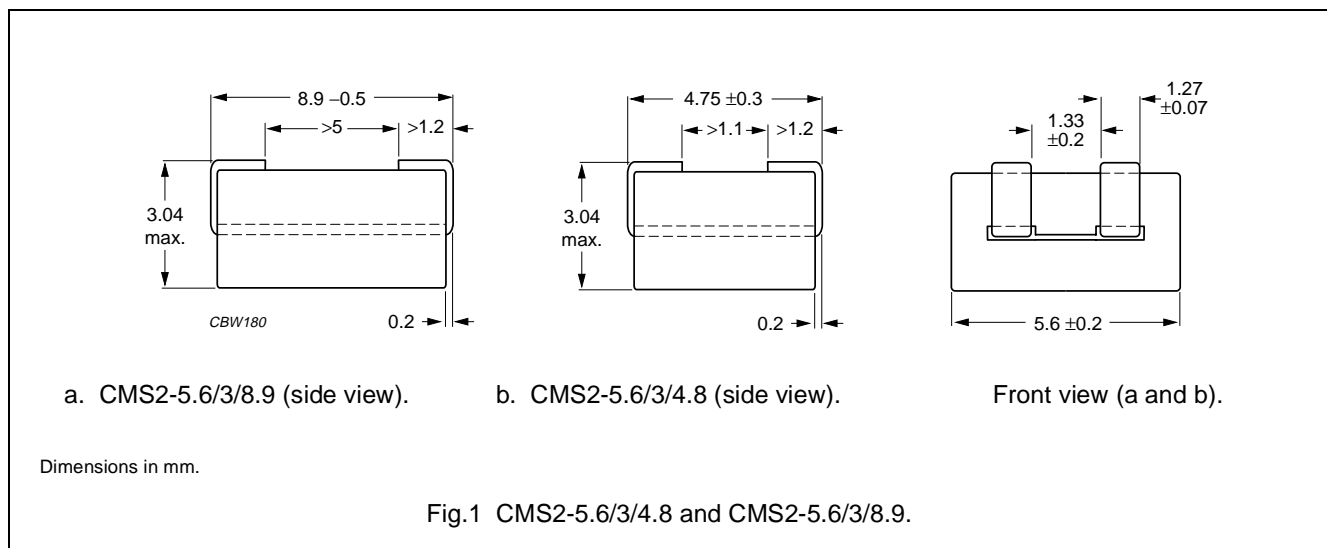

EMI-suppression products

SMD common mode chokes

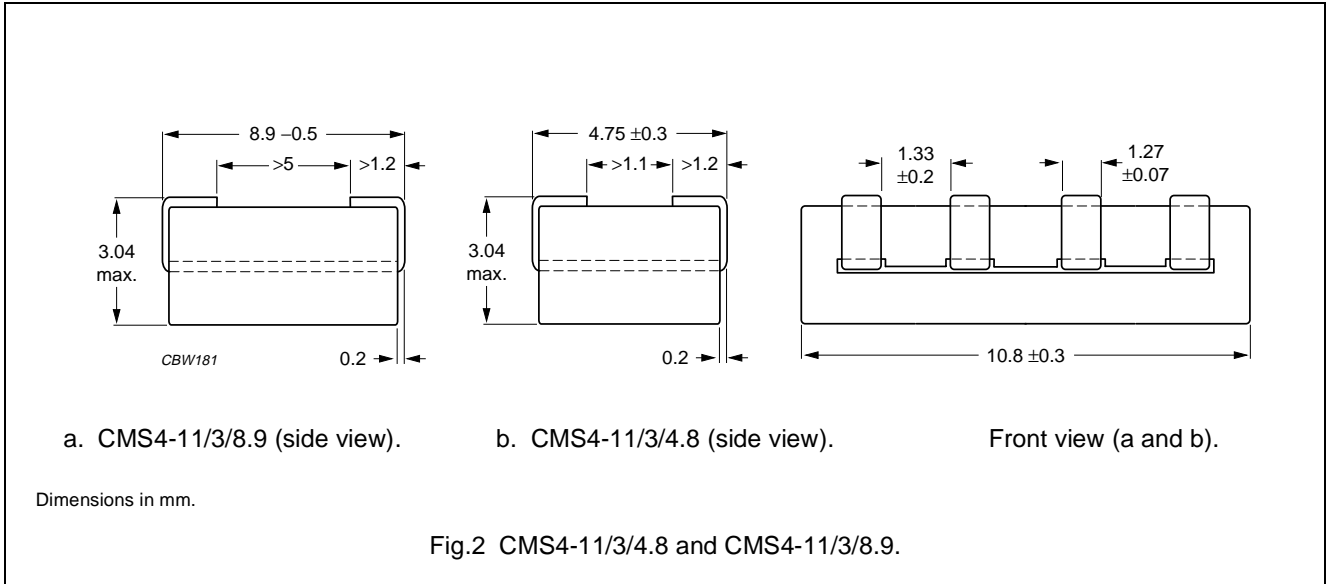

Recommended dimensions of solder lands

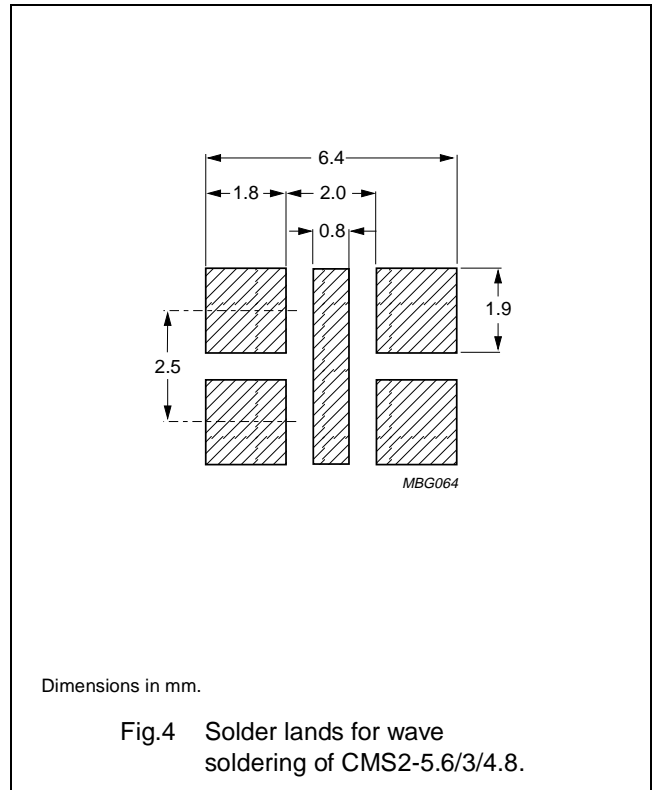
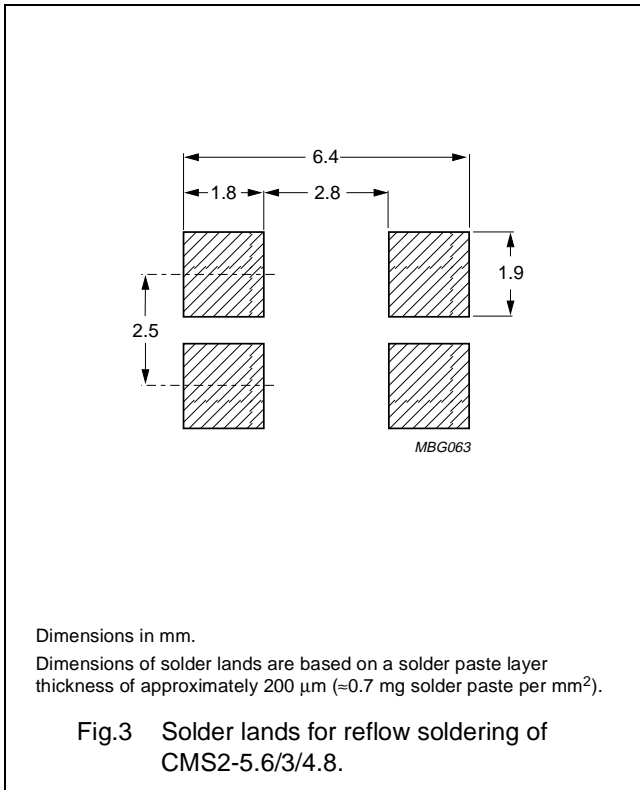

EMI-suppression products

SMD common mode chokes

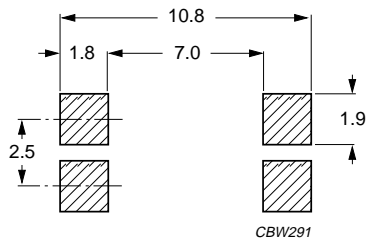

Dimensions in mm.  
 Dimensions of solder lands are based on a solder paste layer thickness of approximately 200 μm (=0.7 mg solder paste per mm<sup>2</sup>).

Fig.5 Solder lands for reflow soldering of CMS2-5.6/3/8.9.

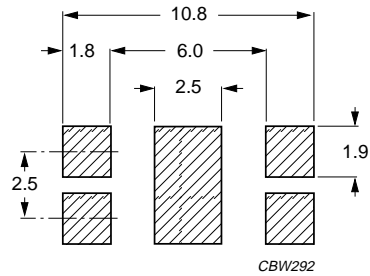

Dimensions in mm.

Fig.6 Solder lands for wave soldering of CMS2-5.6/3/8.9.

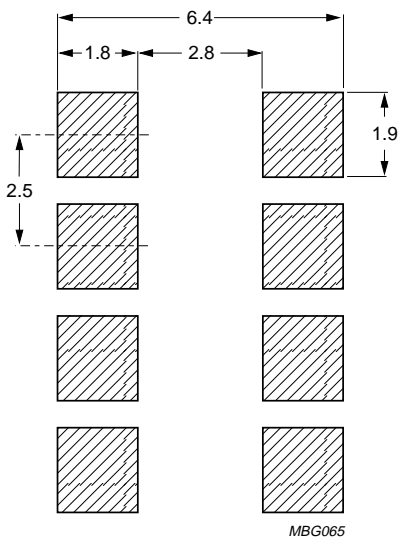

Dimensions in mm.  
 Dimensions of solder lands are based on a solder paste layer thickness of approximately 200 μm (=0.7 mg solder paste per mm<sup>2</sup>).

Fig.7 Solder lands for reflow soldering of CMS4-11/3/4.8.

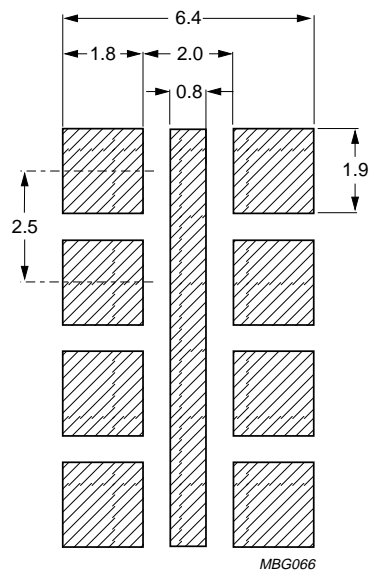

Dimensions in mm.

Fig.8 Solder lands for wave soldering of CMS4-11/3/4.8.

EMI-suppression products

SMD common mode chokes

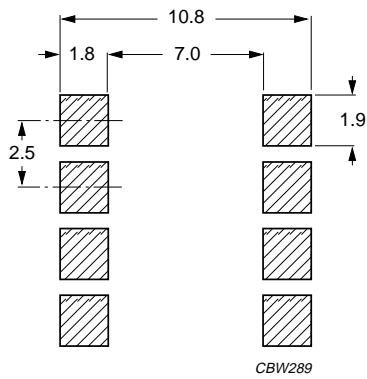

Dimensions in mm.  
 Dimensions of solder lands are based on a solder paste layer thickness of approximately 200  $\mu\text{m}$  (=0.7 mg solder paste per  $\text{mm}^2$ ).

Fig.9 Solder lands for reflow soldering of CMS4-11/3/8.9.

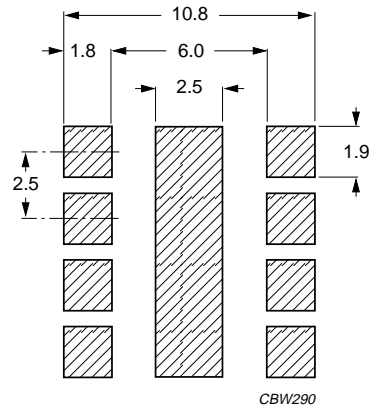

Dimensions in mm.

Fig.10 Solder lands for wave soldering of CMS4-11/3/8.9.

Soldering profiles

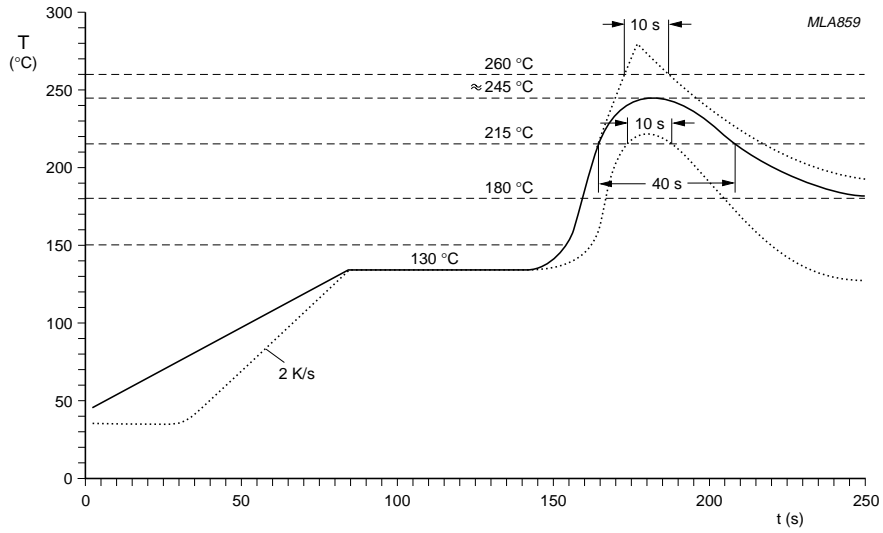

Typical values (solid line).  
Process limits (dotted lines).

Fig.11 Reflow soldering.

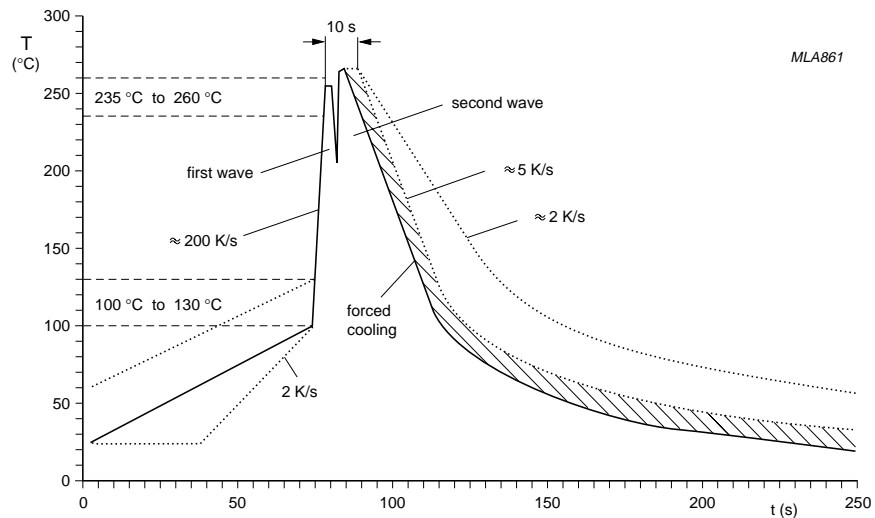

Typical values (solid line).  
Process limits (dotted lines).

Fig.12 Double wave soldering.

**BLISTER TAPE AND REEL DIMENSIONS**

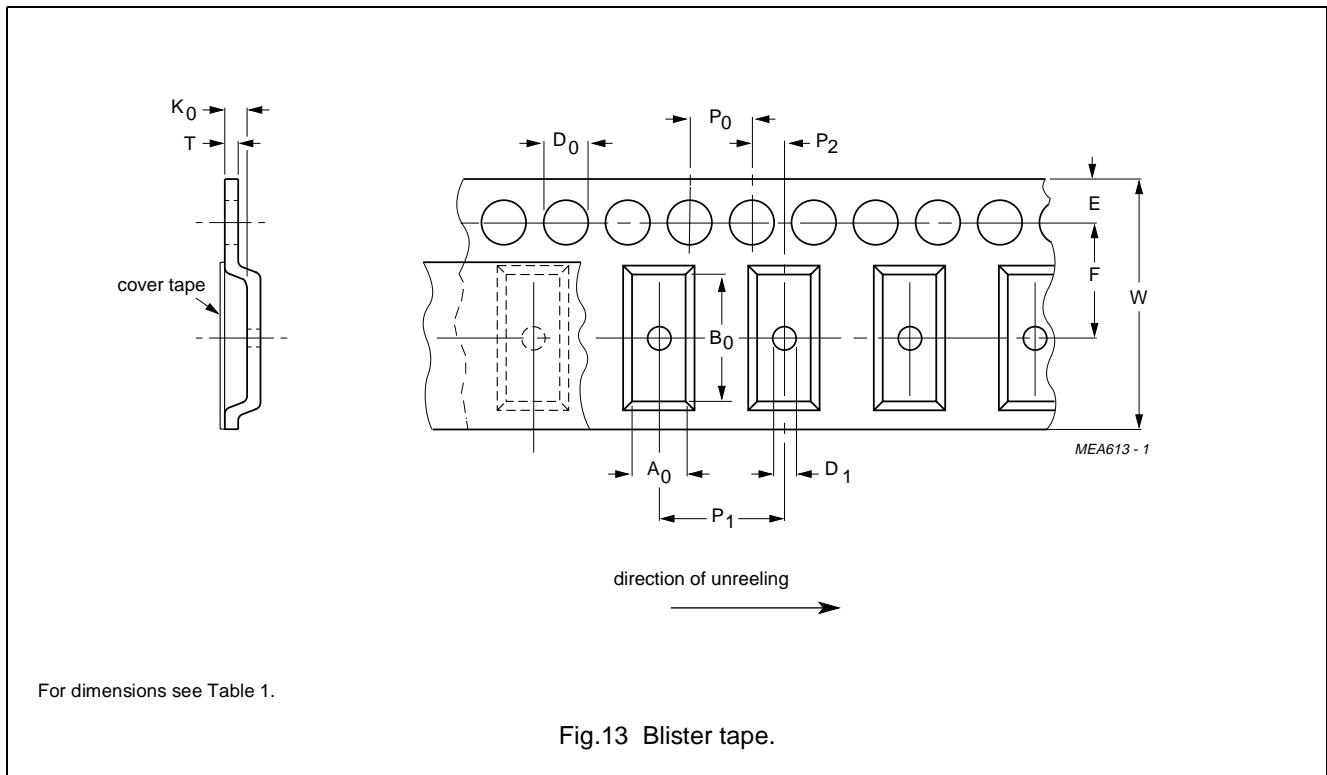

**Table 1** Physical dimensions of blister tape; see Fig.13

SIZE	DIMENSIONS (mm)			
	CMS2-5.6/3/4.8	CMS2-5.6/3/8.9	CMS2-5.6/3/8.9	CMS4-11/3/8.9
A <sub>0</sub>	5.26	5.99	5.23	10.13
B <sub>0</sub>	6.07	9.09	11.18	11.56
K <sub>0</sub>	3.18	3.18	4.5	4.5
T	0.3	0.33	0.34	0.36
W	12	16	24	24
E	1.75	1.75	1.75	1.75
F	5.5	7.5	11.75	11.5
D <sub>0</sub>	1.5	1.5	1.5	1.5
D <sub>1</sub>	≥1.5	≥1.5	≥1.5	≥1.5
P <sub>0</sub>	4.0	4.0	4.0	4.0
P <sub>1</sub>	8.0	8.0	8.0	16.0
P <sub>2</sub>	2.0	2.0	2.0	2.0

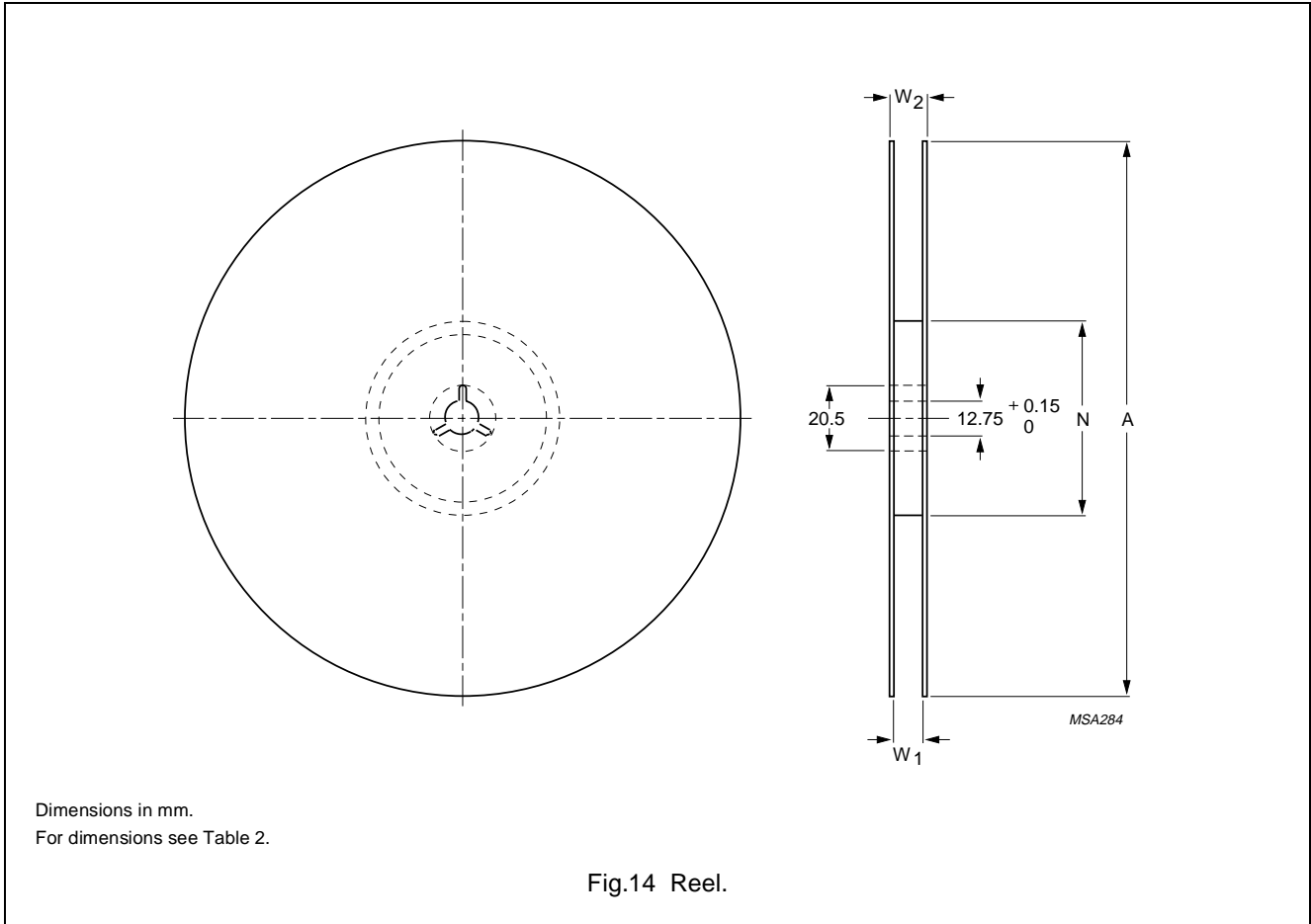

**Table 2** Reel dimensions; see Fig.14

SIZE	DIMENSIONS (mm)			
	A	N	W <sub>1</sub>	W <sub>2</sub>
12	330	100 ±5	12.4	≤16.4
16	330	100 ±5	16.4	≤20.4
24	330	100 ±5	24.4	≤28.4



## EMI-suppression products

## SMD common mode chokes



## DATA SHEET STATUS DEFINITIONS

DATA SHEET STATUS	PRODUCT STATUS	DEFINITIONS
Preliminary specification	Development	This data sheet contains preliminary data. Ferroxcube reserves the right to make changes at any time without notice in order to improve design and supply the best possible product.
Product specification	Production	This data sheet contains final specifications. Ferroxcube reserves the right to make changes at any time without notice in order to improve design and supply the best possible product.

## DISCLAIMER

**Life support applications** — These products are not designed for use in life support appliances, devices, or systems where malfunction of these products can reasonably be expected to result in personal injury. Ferroxcube customers using or selling these products for use in such applications do so at their own risk and agree to fully indemnify Ferroxcube for any damages resulting from such application.

## PRODUCT STATUS DEFINITIONS

STATUS	INDICATION	DEFINITION
<b>Prototype</b>		These are products that have been made as development samples for the purposes of technical evaluation only. The data for these types is provisional and is subject to change.
<b>Design-in</b>		These products are recommended for new designs.
<b>Preferred</b>		These products are recommended for use in current designs and are available via our sales channels.
<b>Support</b>		These products are <b>not</b> recommended for new designs and may not be available through all of our sales channels. Customers are advised to check for availability.