

ST 2SC2884U

NPN Silicon Epitaxial Planar Transistor

for audio frequency amplifier applications

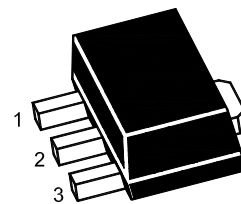

1.Base 2.Collector 3.Emitter
SOT-89 Plastic Package

Absolute Maximum Ratings ($T_a = 25\text{ }^\circ\text{C}$)

Parameter	Symbol	Value	Unit
Collector Base Voltage	V_{CBO}	35	V
Collector Emitter Voltage	V_{CEO}	30	V
Emitter Base Voltage	V_{EBO}	5	V
Collector Current	I_C	800	mA
Collector Power Dissipation	P_C	500	mW
Junction Temperature	T_J	150	$^\circ\text{C}$
Storage Temperature Range	T_S	- 55 to + 150	$^\circ\text{C}$

Characteristics at $T_a = 25\text{ }^\circ\text{C}$

Parameter	Symbol	Min.	Typ.	Max.	Unit	
DC Current Gain at $V_{CE} = 1\text{ V}$, $I_C = 100\text{ mA}$ at $V_{CE} = 1\text{ V}$, $I_C = 700\text{ mA}$	Current Gain Group O	h_{FE}	100	-	200	-
	Current Gain Group Y	h_{FE}	160	-	320	-
	h_{FE}	35	-	-	-	
Collector Base Cutoff Current at $V_{CB} = 35\text{ V}$	I_{CBO}	-	-	0.1	μA	
Emitter Base Cutoff Current at $V_{EB} = 5\text{ V}$	I_{EBO}	-	-	0.1	μA	
Collector Base Breakdown Voltage at $I_C = 100\text{ }\mu\text{A}$	$V_{(BR)CBO}$	35	-	-	V	
Collector Emitter Breakdown Voltage at $I_C = 10\text{ mA}$	$V_{(BR)CEO}$	30	-	-	V	
Emitter Base Breakdown Voltage at $I_E = 100\text{ }\mu\text{A}$	$V_{(BR)EBO}$	5	-	-	V	
Collector Emitter Saturation Voltage at $I_C = 500\text{ mA}$, $I_B = 20\text{ mA}$	$V_{CE(sat)}$	-	-	0.5	V	
Base Emitter On Voltage at $V_{CE} = 1\text{ V}$, $I_C = 10\text{ mA}$	$V_{BE(on)}$	0.5	-	0.8	V	
Transition Frequency at $V_{CE} = 5\text{ V}$, $I_C = 10\text{ mA}$	f_T	-	120	-	MHz	
Output Capacitance at $V_{CB} = 10\text{ V}$, $f = 1\text{ MHz}$	C_{ob}	-	13	-	pF	

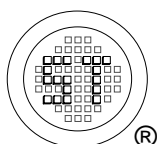

SEMTECH ELECTRONICS LTD.

(Subsidiary of Sino-Tech International Holdings Limited, a company listed on the Hong Kong Stock Exchange, Stock Code: 724)



ISO/TS 16949 : 2002
Certificate No. 05103



ISO 14001:2004
Certificate No. 7116



ISO 9001:2000
Certificate No. 0506098

Dated : 03/01/2008

ST 2SC2884U

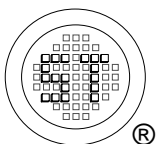
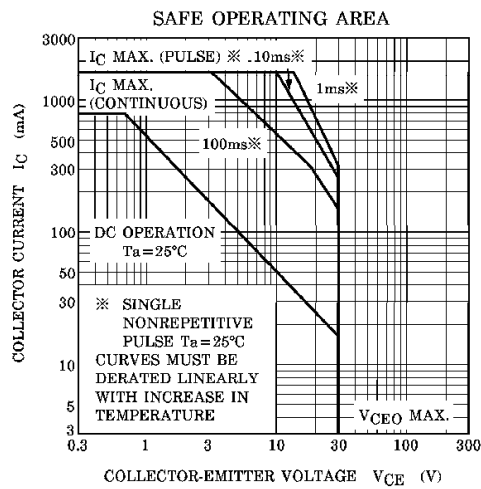
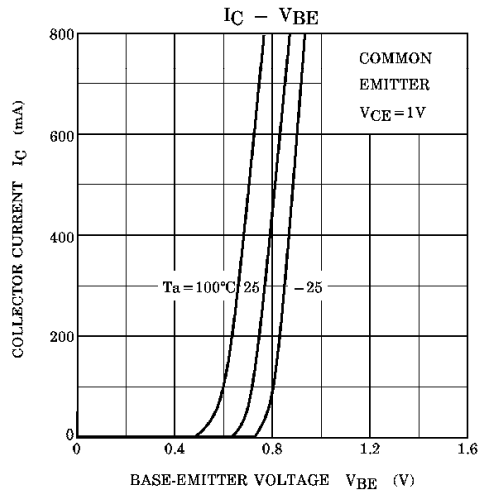
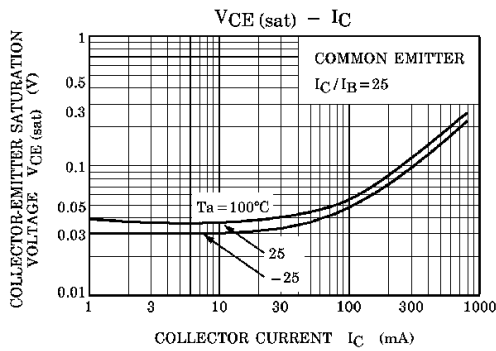
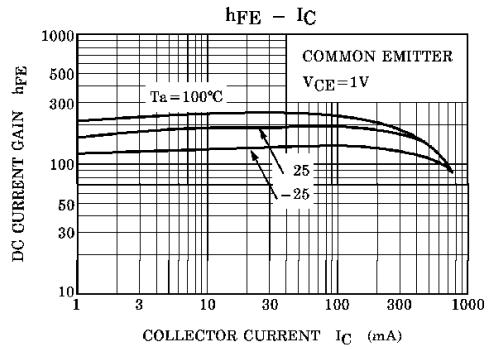
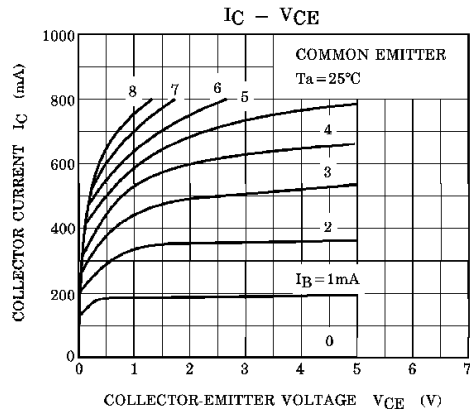

SEMTECH ELECTRONICS LTD.

(Subsidiary of Sino-Tech International Holdings Limited, a company listed on the Hong Kong Stock Exchange, Stock Code: 724)



ISO/TS 16949 : 2002
Certificate No. 05103



ISO 14001:2004
Certificate No. 71116



ISO 9001:2000
Certificate No. 0506098

ST 2SC2884U

SOT-89 PACKAGE OUTLINE

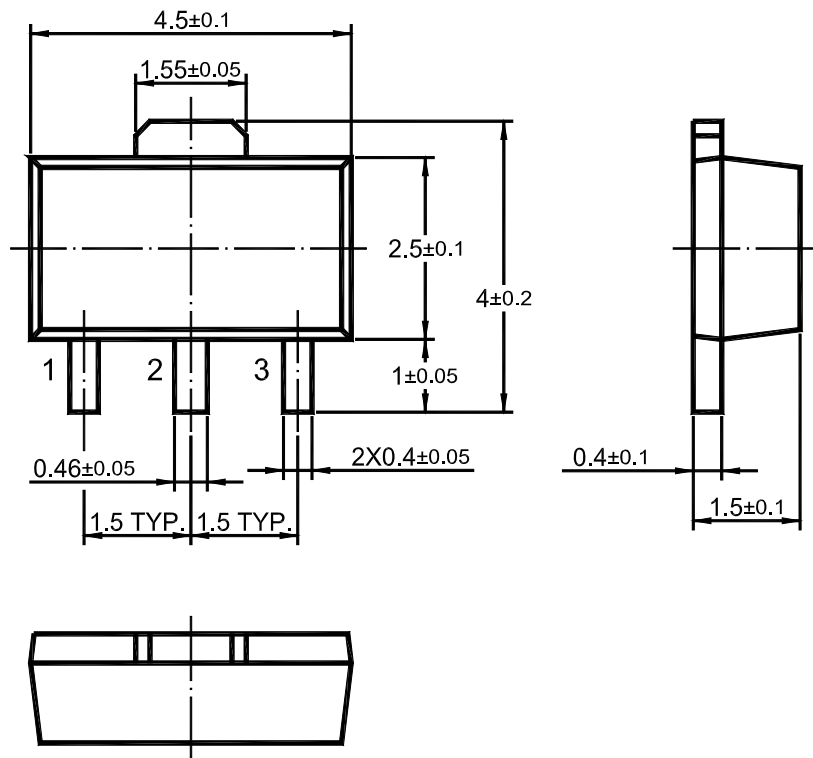

Dimensions in mm

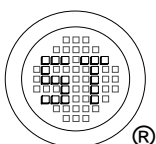

SEMTECH ELECTRONICS LTD.

(Subsidiary of Sino-Tech International Holdings Limited, a company listed on the Hong Kong Stock Exchange, Stock Code: 724)



Dated : 03/01/2008