

Model WS60 with absolute or incremental encoder output

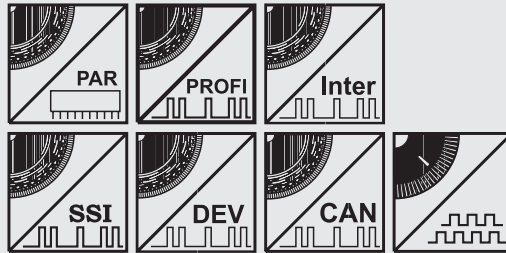

Industrial position sensor for very long measurement ranges

- Protection class IP52
- Measurement ranges:
0 ... 15000 mm, 30000 mm, 60000 mm
- With absolute or incremental encoder output



Specifications	Outputs	Incremental encoder with TTL or HTL output Absolute encoder (see order code)		
	Resolution		15000 mm	30000 mm
	Pulses resp. steps per mm	16	10	8
Material	Aluminium and stainless steel. Cable: stainless steel			
Sensing device	Incremental encoder or absolute encoder			
Connector	Depending on the encoder type			
Linearity	±0.1 % full scale, optional ±0.025 % full scale			
Weight	15 kg max.			
Environmental				
EMC	Refer to output specification			
Temperature	Refer to output specification			

Order Code WS60

absolute/incremental

Model Name

WS60 - [] - [] - [] - []

Measurement Range (in mm)

15000 / 30000 / 60000

Outputs (see pages 61 ff.)

LD5VC = Incremental encoder TTL compatible inverted

PP24VC = Incremental encoder HTL compatible inverted

HSSI = Absolute encoder with synchronous serial output (SSI)

HSSIP = Absolute encoder with synchronous serial output (SSI), programmable

HPROF = Absolute encoder with Profibus interface

HINT = Absolute encoder with Interbus interface

HCAN = Absolute encoder with CAN bus interface

HCANOP = Absolute encoder with CANopen bus interface

HDEV = Absolute encoder with DeviceNet interface

HPAR = Absolute encoder with parallel interface

Linearity (option)

L025 = ±0.025 %

Cable fixing

M4 = M4 cable fixing

SB0 = Cable clip

Order Code Mating Connector (see accessories page 82)

Incremental, SSI: **CONN-CONIN-12F-G**

Order Example: WS60 - 60000 - HSSI - M4

Model WS60 with absolute or incremental encoder output



Cable Forces typical at 20 °C	Range	Maximum Pull-out Force	Minimum Pull-in Force
	[mm]	[N]	[N]
	15000	10.5	5.0
	30000	14.5	6.2
	60000	17.0	6.5

Outline drawing

(WS60-15000)

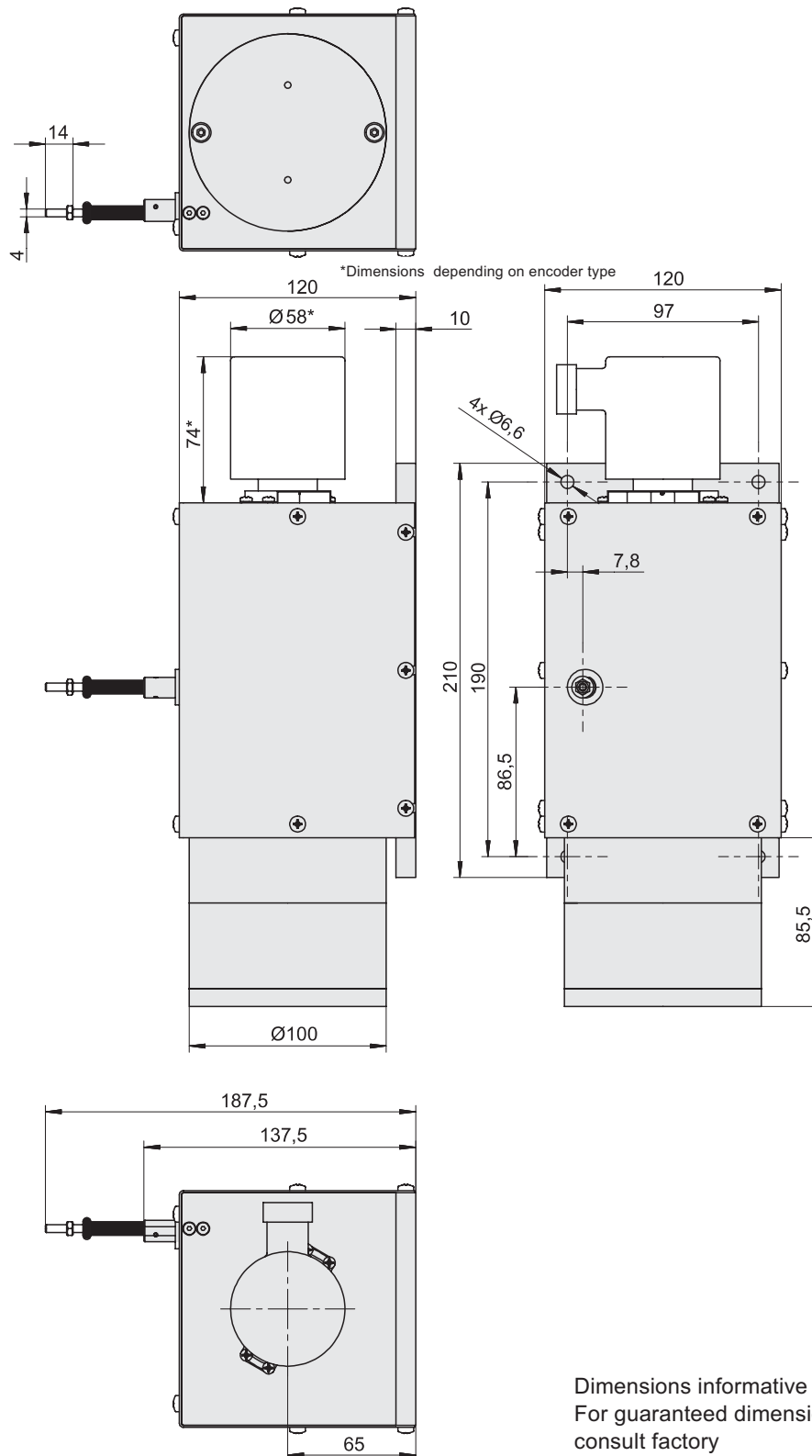

Dimensions informative only.
For guaranteed dimensions
consult factory

Model WS60 with absolute or incremental encoder output



Outline drawing
(WS60-30000)

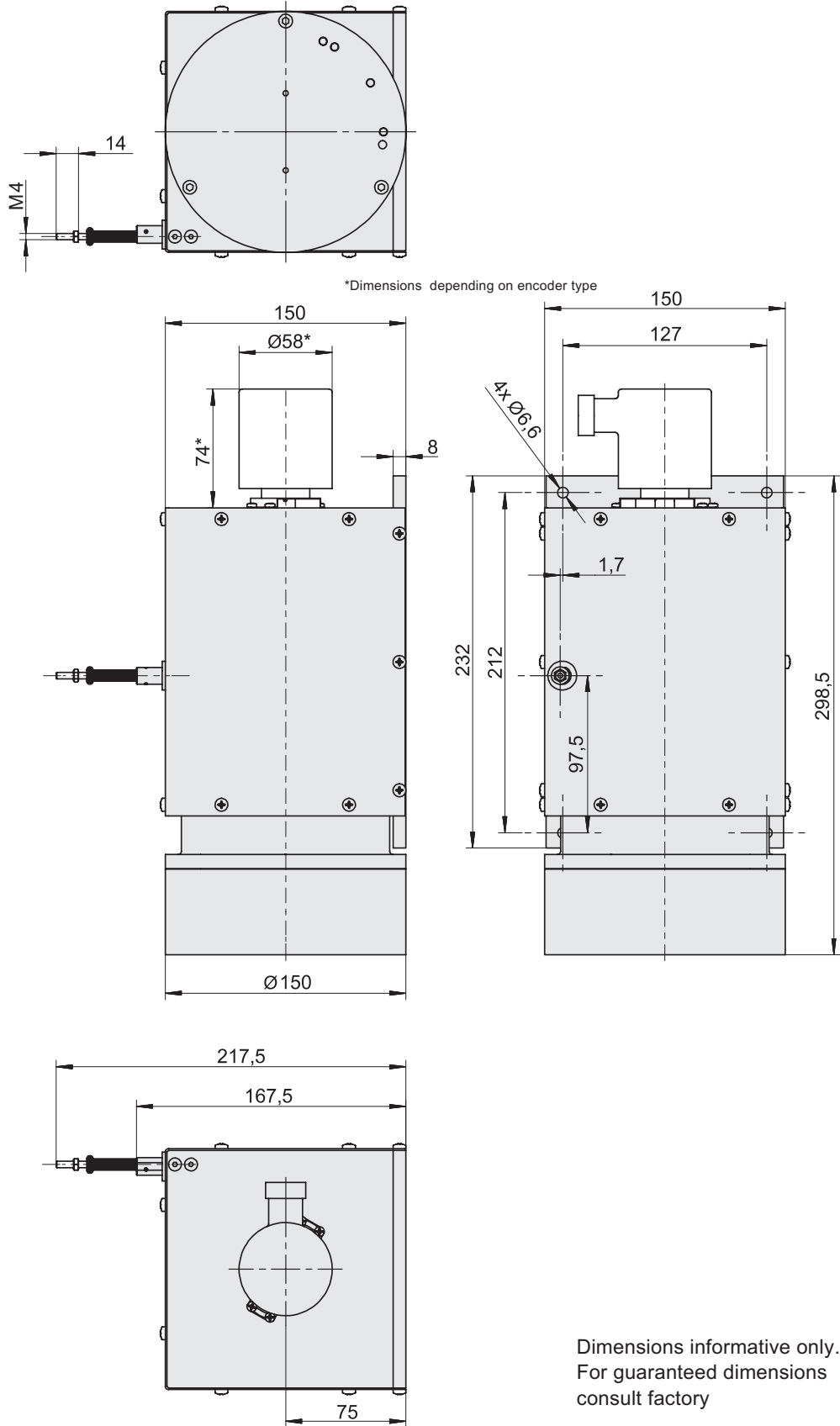

Dimensions informative only.
For guaranteed dimensions
consult factory

Model WS60 with absolute or incremental encoder output



Outline drawing
(WS60-60000)

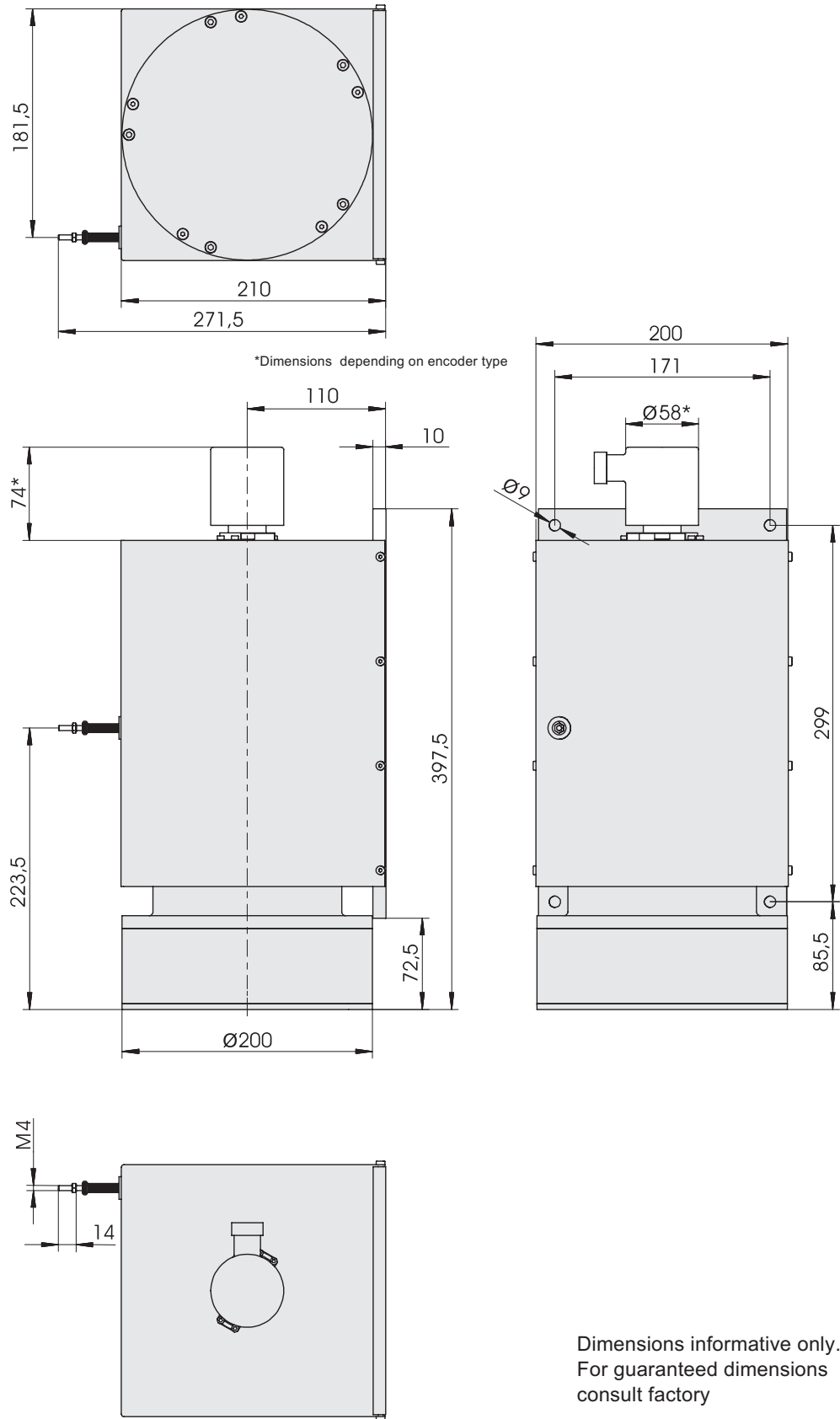

Dimensions informative only.
For guaranteed dimensions
consult factory

Output Specifications

IE58LI and IE58HI (IE41LI and IE41HI)

for WS position sensors



IE58LI and IE58HI incremental		
	IE58LI / IE41LI	IE58HI / IE41HI
	Excitation voltage	5 V DC $\pm 10\%$
	Excitation current	120 mA max.
	Max. frequency	300 kHz
	Output	RS422
	Output current	± 30 mA
	Output voltage	Depending on the excitation voltage
	Stability (temperature)	$\pm 20 \times 10^{-6} / ^\circ\text{C}$ f.s. (sensor mechanism)
	Operation temperature	$-10 \dots +70$ °C
	Protection against short circuit	1 channel for 1 s max.
	EMC	According to EN 61326:2004

Output circuit and recommended processing input circuit

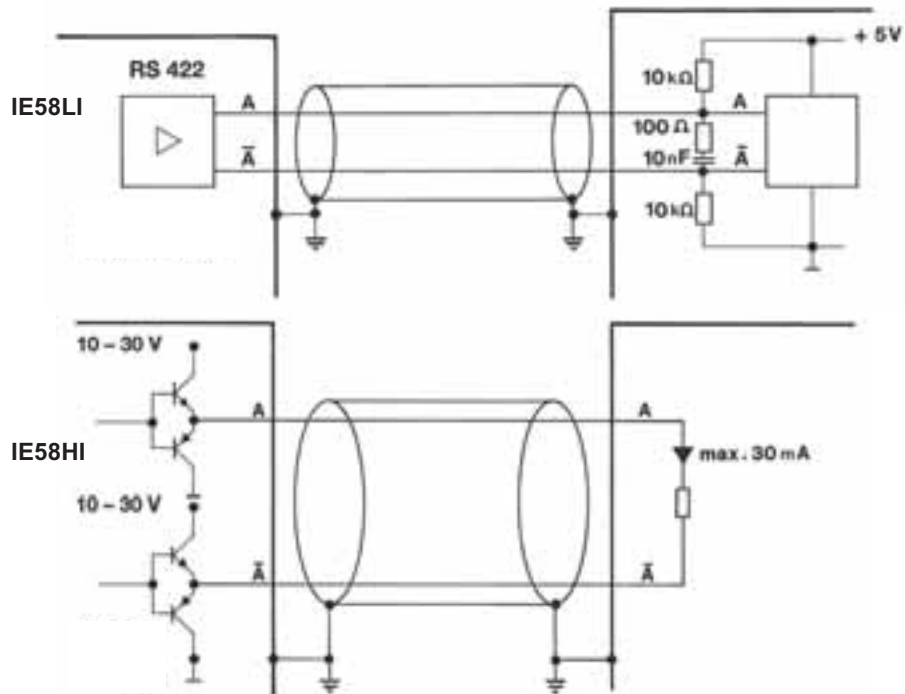

Output signals

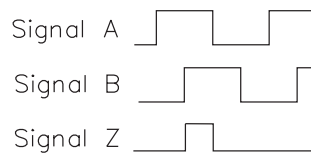

Signal wiring	Output signals	Connector CONN-CONIN-12F
	Excitation +	
Excitation GND (0V)		10
Signal A		5
Signal \bar{A}		6
Signal B		8
Signal \bar{B}		1
Signal Z (reference pulse)		3
Signal \bar{Z}		4

Connection

Mating connector

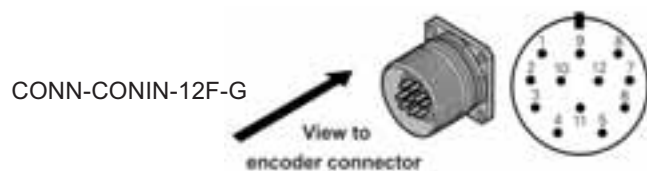

Output Specification for absolute encoders with SSI interface



Signal Conditioner HSSI Absolute Encoder synchronous serial 	Excitation voltage	10 ... 30 V DC
	Excitation current	100 mA
	Interface	Standard SSI
	Lines / drivers	Clock and data / RS-422
	Code	Gray
	Resolution multiturn	12 + 12 bit
	3 dB cutoff frequency	500 kHz
	Control input	Direction
	Alarm output	Alarm bit (SSI option), warning bit
	Status LED	Green = OK, red = alarm
	Connection	Cable or male socket 12 pin

Data format	Resolution	Clock												
		T1 T2 T3 ... T12 T13 ... T21 T22 T23 T24 T25 T26												
		Data bits												
	24 bit	M11 M10 M9 ... M0 S11 ... S3 S2 S1 S0 0												

Mx = multiturn bits, Sx = single turn bits

Transmission rate	Cable length	Baud rate	Note: Extension of the cable length will reduce the maximum transmission rate. The signals <u>CLOCK/CLOCK</u> and <u>DATA/DATA</u> must be connected in a twisted pair cable, shielded per pair and common.
	< 50 m	< 400 kHz	
	< 100 m	< 300 kHz	
	< 200 m	< 200 kHz	
	< 400 m	< 100 kHz	

Signal names	Color	Connector pin no.
Excitation +	white	8
Excitation GND (0V)	brown	1
CLOCK	yellow	3
CLOCK	green	11
DATA	pink	2
DATA	grey	10
Direction *	blue	5
0 V signal output	black	12

* Excitation + = cw increasing code, 0 V = cw decreasing code

Connection

Mating Connector

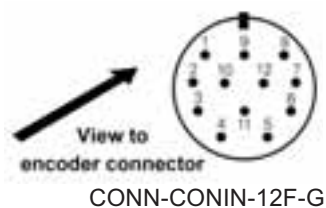

Output Specification for absolute encoders with programmable SSI interface



Programmable Signal Conditioner HSSI Absolute Encoder synchronous serial 	Excitation voltage	10 ... 30 V DC
	Excitation current	250 mA
	Interface	SSI programmable
	Lines/drivers	Clock and data / RS-422
	Code	Binary or Gray, programmable
	Resolution	13 (9 ... 20 bit) + 12 bit
	Format	MSB justified or fir tree
	Programmability	Resolution, code, rotating direction, format, warning, alarm
	Control input	Direction, Preset1, Preset2
	Reset button under housing cover	Lockable by programming
	Alarm output	Alarm bit (SSI option), warning bit
	Status LED	Green = ok, red = alarm
	Connection	Cable or male socket 12 pin

Transmission rate	Cable length	Baud rate	Note: Extension of the cable length will reduce the maximum transmission rate. The signals CLOCK/CLOCK and DATA/DATA must be connected in a twisted pair cable, shielded per pair and common.
	< 50 m	< 400 kHz	
	< 100 m	< 300 kHz	
	< 200 m	< 200 kHz	
	< 400 m	< 100 kHz	

Signal Wiring / Connection	Signal names	Color	CONN-CONIN-12F
	Excitation +	white *	11
	Excitation GND (0V)	brown *	12
	CLOCK	yellow	2
	CLOCK	green	1
	DATA	pink	3
	DATA	grey	4
	Direction	blue	8
	0 V signal output	black	7
	RS-232 TxD	brown	5
	RS-232 RxD	white	6
	Preset 1	red	9
	Preset 2	violet	10

* = larger width 0,5 mm²

Connection Mating Connector

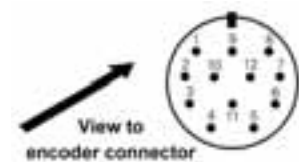

CONN-CONIN-12F-G

Output Specification for absolute encoders with Profibus interface



Interface HPROF Absolute Encoder Profibus 	Excitation voltage	10 ... 30 V DC
	Excitation current	250 mA
	Interface	RS-485
	Protocol	Profibus DP with encoder profile class C2
	Resolution	12 (10 ... 14) + 12 bit
	Output code	Binary
	Baudrate	Automatically selected between 9,6 kBaud and 12 MBaud
	Programmability	Resolution, preset, direction
	Integrated special functions	Velocity, acceleration, operating time
	Bus terminating resistor	Selectable via DIP switch
	Connection	Bus cover with T-manifold
	EMC	EN61326 : class A

Signal name	Cable terminal no. (bus cover)
UB in	1
0V in	2
UB out	3
0V out	4
B in	5
A in	6
B out	7
A out	8

Output Specification for absolute encoders with Parallel interface



Interface HPAR Absolute Encoder Parallel 	Excitation voltage	10 ... 30 V DC
	Excitation current	300 mA
	Interface	Parallel
	Output code	Binary, Gray, Gray Excess
	Resolution	12 bit + 12 bit
	Output current	30 mA per bit short circuit protected
	Alarm output	NPN open collector 5 mA max.
	Control inputs	Latch, Direction, Tristate
	Connection	Cable 0.1 m with SUB-D 37 pin connector

Control inputs	Input name	Level (physical)	Function
	Direction	1 (+UB or open input)	CW increasing code values
		0 (0 V)	CW decreasing code values
	Latch	1 (+UB or open input) 0 (0 V)	Encoder data free running Encoder data stored (data hold)
	Tristate	1 (+UB)	Outputs in tristate condition
		0 (0 V or open input)	Outputs active

Switching delay 10 μs typ. for push-pull operation, for open collector signals an external pull-down resistor (1 kΩ) is necessary.

Signal Wiring / Connection	Signal names	Color	Connector SUB-D 37 pin	
	S0	brown	2	
	S1	green	21	
	S2	yellow	3	
	S3	grey	22	
	S4	pink	4	
	S5	violet	23	
	S6	Singleturn bits	grey/pink	5
	S7		red/blue	24
	S8	white/green	6	
	S9	brown/green	25	
	S10	white/yellow	7	
	S11	yellow/brown	26	
	M0	Multiturn bits	white/grey	8
	M1		grey/brown	27
	M2		white/pink	9
	M3		pink/brown	28
	M4		white/blue	14
	M5		brown/blue	33
	M6		white/red	15
	M7		brown/red	34
	M8		white/black	16
	M9		brown/black	35
	M10		grey/green	17
	M11	yellow/grey	36	
	Alarm		pink/green	18
	Direction		yellow/pink	10
Latch		green/blue	30	
Tristate		yellow/blue	12	
10...30 V DC		red (0.5 mm2)	13	
10...30 V DC		white (0.5 mm2)	31	
0 V		blue (0.5 mm2)	1	
0 V		black (0.5 mm2)	20	

Connection Mating Connector

View to encoder connector

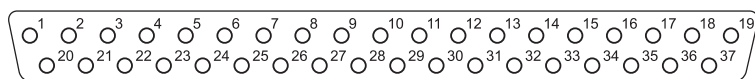

CONN-SUBD-37F

Output Specification for absolute encoders with Interbus interface



Interface HINT Absolute Encoder Interbus 	Excitation voltage	10 ... 30 V
	Excitation current	250 mA
	Interface	Interbus, ENCOM Profile K3 (programmable), K2
	Output code	Binary 32 bit
	Baud rate	500 kBaud
	Data refresh	Every 600 µs
	Resolution	12 (10 ... 12) + 12 bit
	Programmability	Direction, preset, offset, resolution
	Connection	Bus cover with T-manifold
	EMC	EN 50081-2, 50082-2

Data format Interbus K2		Differential signals (RS485) ENCOM profile K3, K2, 32 bit, binary process data				
	DT format	S _{mpi} address	0	1	2	3
	(according to the Phoenix company)	Byte no.	3	2	1	0
	ID code K2		36 H (= 54 dec.)			
	ID code K3		37 H (= 55 dec.)			

Signal wiring / connection	Signal names	Cable terminal no. (bus cover)
		UB +
	GND	2
	DI1	3
	DI1	4
	DO1	5
	DO1	6
	DO2	7
	DO2	8
	DI2	9
	DI2	10
	RBST	11
	GND	12

Output Specification for absolute encoders with DeviceNet interface



Interface HDEV Absolute Encoder DeviceNet 	Excitation voltage	10 ... 30 V DC
	Excitation Current	250 mA
	Interface	CAN highspeed according ISO/DIS 11898 CAN specification 2.0 A (11 bit identifier)
	Protocol	DeviceNet according to Rev. 2.0, programmable encoder
	Resolution	12 (10 ... 14) + 12 bit
	Programmable	Resolution, preset, direction
	Output code	Binary
	MAC ID	Selectable via DIP switch
	Data refresh	Every 5 ms
	Baud rate	Selectable 125, 250, 500 kBaud, DIP switch
	Bus terminating resistor	Selectable via DIP switch
	Connection	Bus cover with T-manifold
	EMC	EN 50081-2, 50082-2

Recommended transmission	Characteristic impedance	135 ... 165 Ω (3...20 MHz)
	Operating capacity	< 30 pF
	Loop resistance	< 110 Ω /km
	Wire diameter	> 0.63 mm
	Wire width	> 0.34 mm ²

Transmission rate	Segment length	Kbit/s
	500 m	125
	250 m	250
	100 m	500

Signal Wiring / Connection	Signal name	Cable terminal no. (bus cover)
	UB in	1
	0V in	2
	CAN-L	3
	CAN-H	4
	Drain	5
	Drain	6
	CAN-H	7
CAN-L	8	

Output Specification for absolute encoders with CAN interface



Interface HCAN/HCANOP Absolute Encoder CANopen/CAN Layer 2 	Excitation voltage	10 ... 30 V DC
	Excitation current	250 mA
	Interface	CAN highspeed according ISO/DIS 11898
	Protocol	CANopen according to DS301 with encoder profile DSP 406, programmable encoder according to class 2
	Resolution	12 (10 ... 14) + 12 bit
	Programmable	CANopen: direction, resolution, preset, offset; CAN L2: direction, limit values
	Output code	Binary
	Data refresh	Every millisecond (adjustable), on request
	Baud rate	Selectable 10 to 1000 kBaud
	Base identifier	Selectable via DIP switches
	Integrated special functions	CANopen: speed, acceleration, limit values CAN L2: direction, limit values
	Connection	Bus cover with T-manifold
	EMC	EN 50081-2, EN50082-2

Signal wiring / connection	Signal names	Cable terminal no. (bus cover)
	UB in	1
	0V in	2
	CAN in – (dominant L)	3
	CAN in + (dominant H)	4
	CAN GND in	5
	CAN GND out	6
	CAN out + (dominant H)	7
	CAN out - (dominant L)	8
	0V out	9
	UB out	10