

Specifications are subject to change without notice.

DESCRIPTION

MGFS36E3436A is a GaAs RF amplifier designed for WiMAX CPE.

FEATURES

- InGaP HBT Device
- 6V Operation
- 30dB Linear Gain
- 2.5% EVM at an Output power of 25dBm
- 4% EVM at an Output power of 27dBm
- Integrated Output Power Detector
- Integrated 1-bit 21dB Step Attenuator
- 50Ω Matched Input/Output Ports
- Surface Mount Package
- RoHS Compliant Package

APPLICATIONS

IEEE802.16-2004, IEEE802.16e-2005

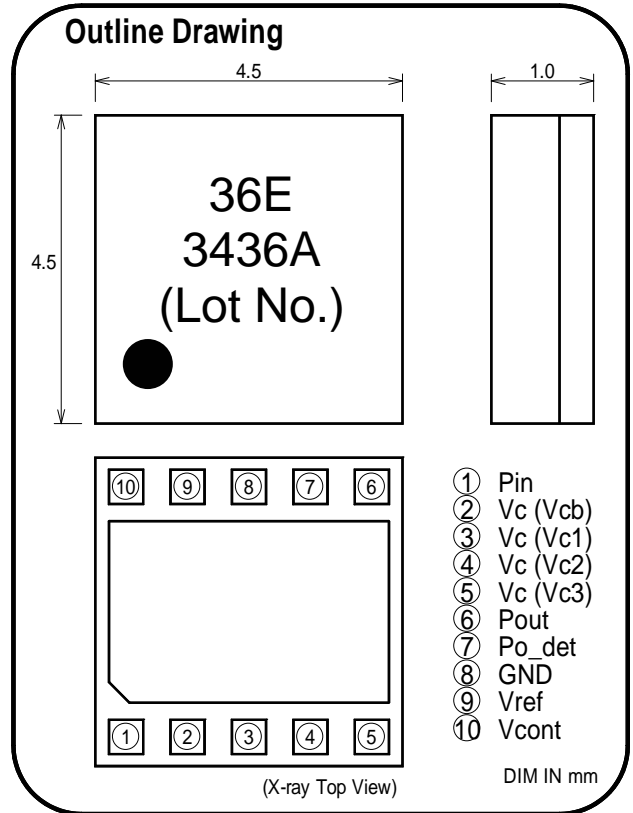

FUNCTIONAL BLOCK DIAGRAM

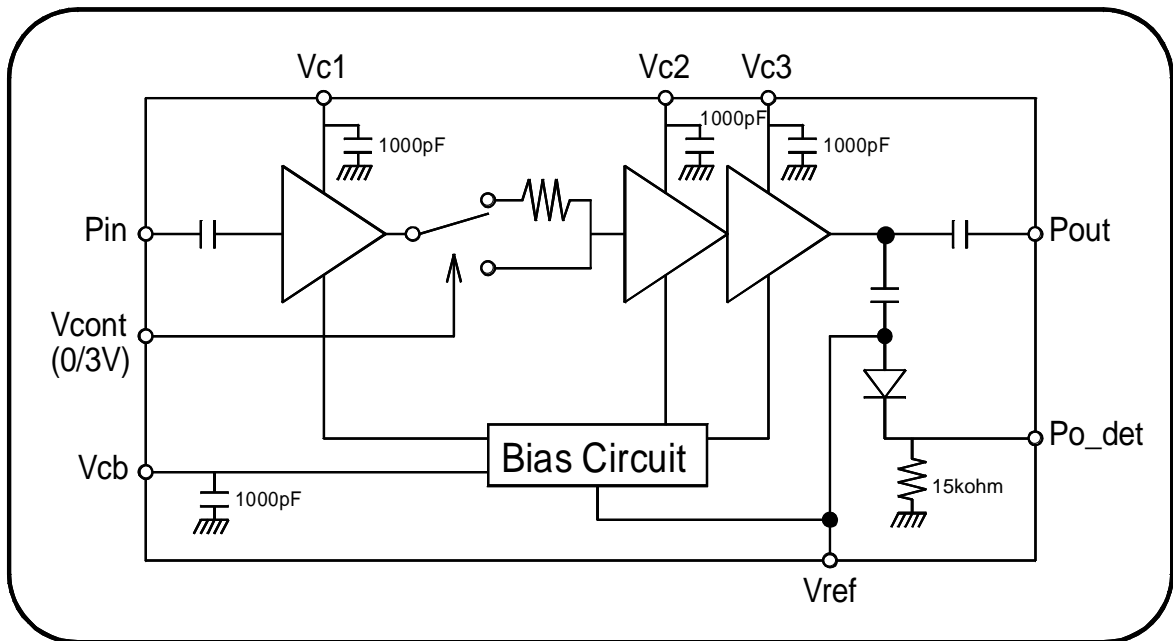

Mitsubishi Electric Corporation puts the maximum effort into making semiconductor products better and more reliable, but there is always the possibility that trouble may occur with them. Trouble with semiconductors may lead to personal injury, fire or property damage. Remember to give due consideration to safety when making your circuit designs, with appropriate measures such as (i) placement of substitutive, auxiliary, circuits, (ii) use of non-flammable material or (iii) prevention against any malfunction or mishap.

Specifications are subject to change without notice.

ABSOLUTE MAXIMUM RATINGS (Tc=25°C)

Symbol	Parameter	Conditions*	Value	Unit
Vc1, Vc2 Vc3, Vcb	Collector Supply Voltage	Pout≤27.0dBm	8	V
Vref	Reference Voltage	Pout≤27.0dBm	3	V
Vcont	ATT Control Voltage	Pout≤27.0dBm	3.3	V
Ic1	Operation Current	Pout≤27.0dBm	180	mA
Ic2			250	mA
Ic3			900	mA
Pin	Input Power	Pout≤27.0dBm	5	dBm
-	Duty Cycle	Pout≤27.0dBm	50	%
Tc(op)	Operation Temperature	Pout≤27.0dBm	-40~+85	°C
Tstg	Storage Temperature	-	-40~+125	°C

*NOTE : Zin=Zout=50Ω

Each maximum rating is guaranteed independently.

Please take care that MGFS36E3436A is operated under these conditions at the worst case on your terminal.

ELECTRICAL CHARACTERISTICS

(Tc=25°C, Vc=6V, Vref=2.85V, Duty Cycle < 50%, 64QAM OFDM Modulation)

Symbol	Parameter	Test Conditions*	Limits			Unit
			Min	Typ	Max	
f	Frequency	-	3.4		3.6	GHz
Gp	Gain			30		dB
ηt	Efficiency	Pout=27dBm		11		%
Pout	Output Power Meets Spectrum Mask	ETSI EN302-326, EqC-PET=0, EqC-EMO=4		28		dBm
		ETSI EN302-326, EqC-PET=0, EqC-EMO=6		26		
EVM	EVM	Pout=25dBm		2.5		%
		Pout=27dBm		4		
Vdet	Power Detector Voltage	Pout=25dBm		1.7		V
		Pout=27dBm		2.0		
ATT	Control Gain Step	Vcont=3V		21		dB
Ileak	Leakage Current	Vc=6V, Vref=0V			10	μA

*NOTE : Zin=Zout=50Ω

ESD RATING - Class 1A (HBM)

MOISTURE SENSITIVITY LEVEL - Level 3

THERMAL RESISTANCE : 30°C/W

Specifications are subject to change without notice.

PERFORMANCE DATA

Vc=6V, Vref=2.85V, Vcont=0V, Duty Cycle=50%
 WiMAX OFDM 64QAM signal input. Tc=25degC.

Output Power vs. Input Power

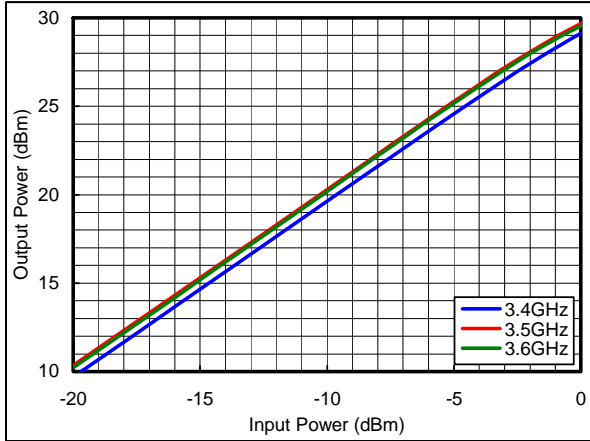

Efficiency vs. Output Power

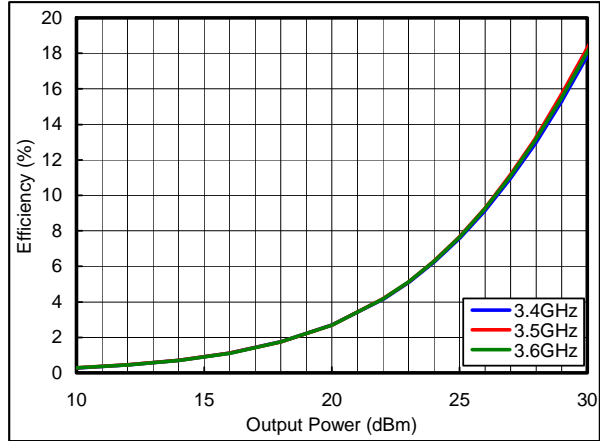

EVM vs. Output Power

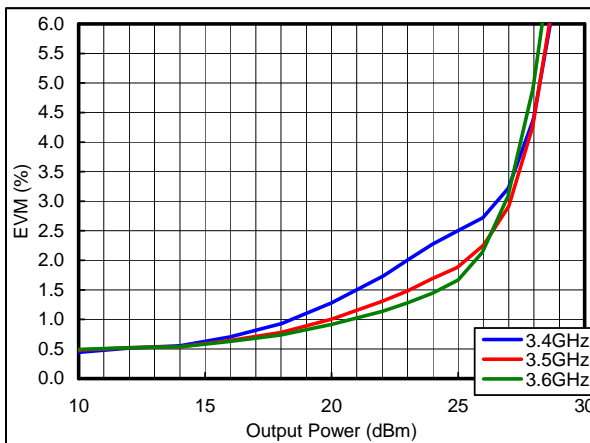

Detector Voltage vs. Output Power

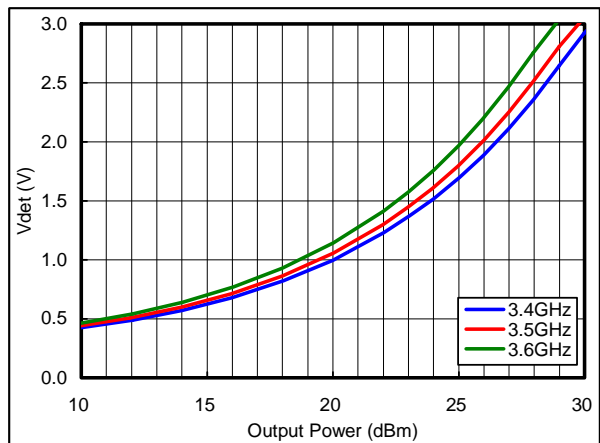

Attenuation Performance

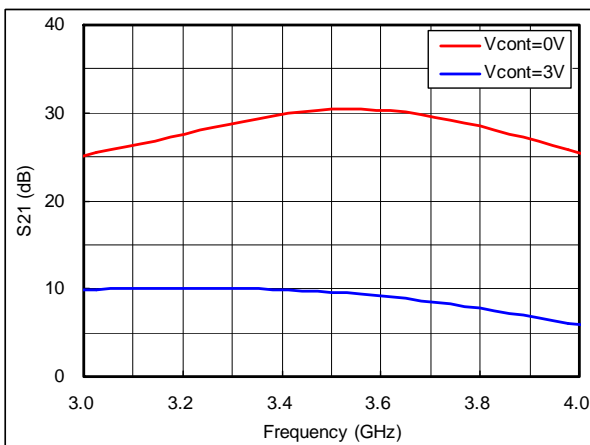

Specifications are subject to change without notice.

$V_c=6V$, $V_{ref}=2.85V$, $V_{cont}=0V$, Duty Cycle=50%
 $f=3.5GHz$, WiMAX OFDM 64QAM signal input.

Output Power vs. Input Power

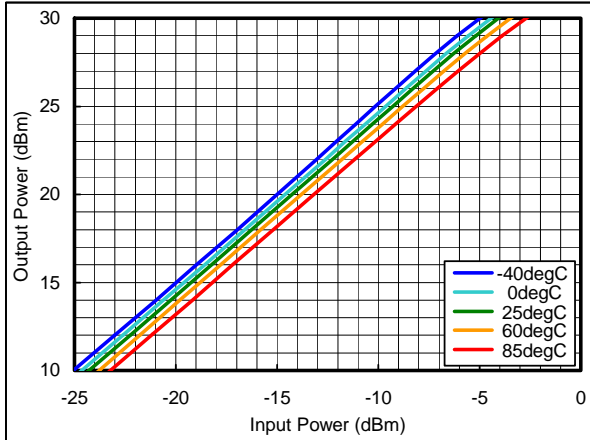

Efficiency vs. Output Power

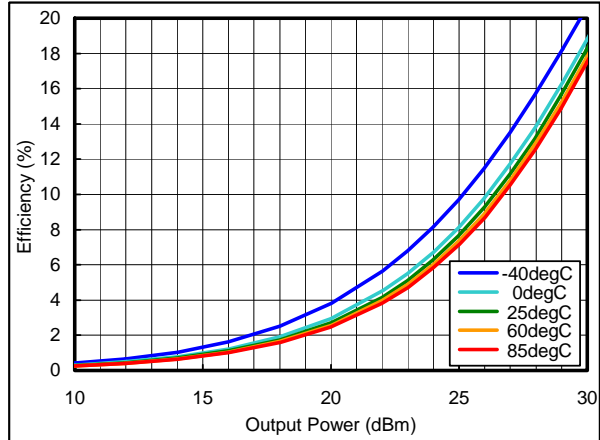

EVM vs. Output Power

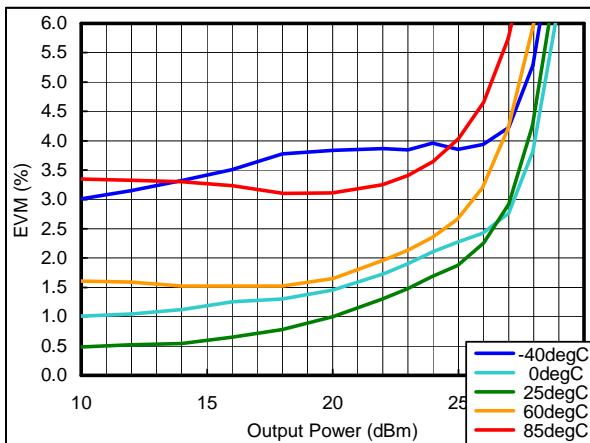

Detector Voltage vs. Output Power

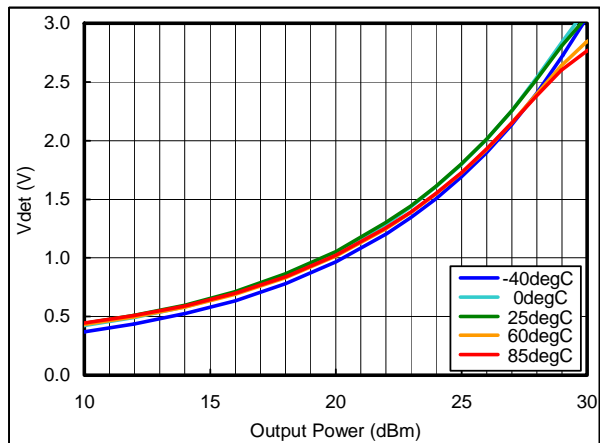

Attenuation Level

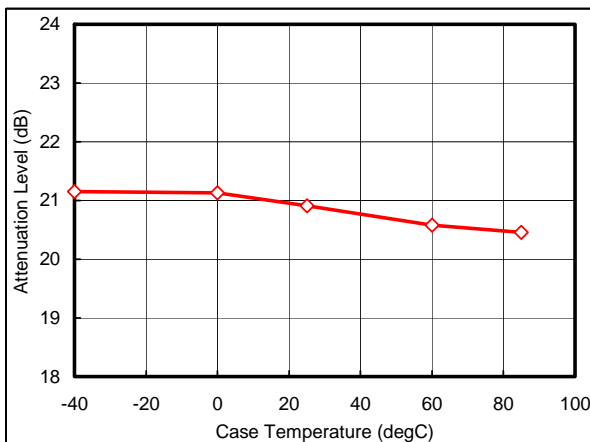

Specifications are subject to change without notice.

Vc=6V, Vref=2.85V, Vcont=0V, Duty Cycle=50%
WiMAX OFDM 64QAM signal input. Tc=25degC.

Output Power vs. Distortion

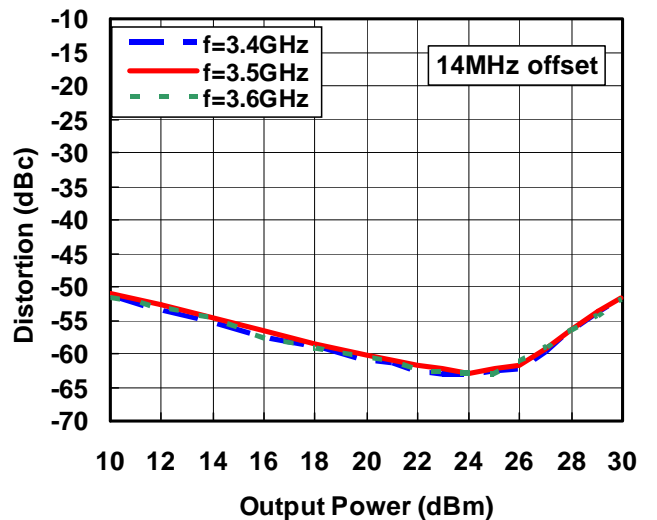
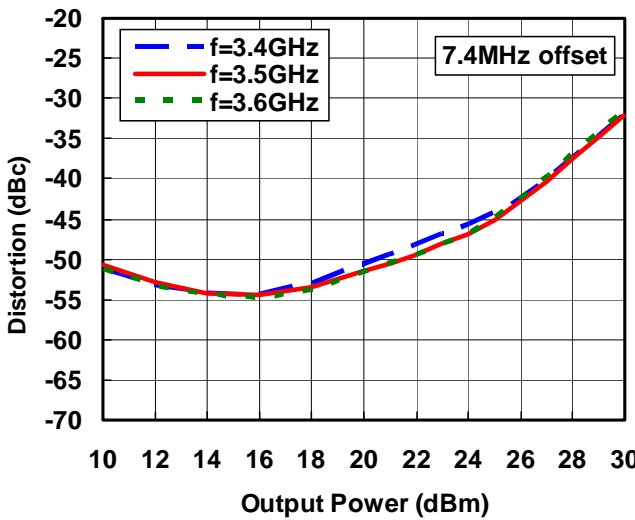
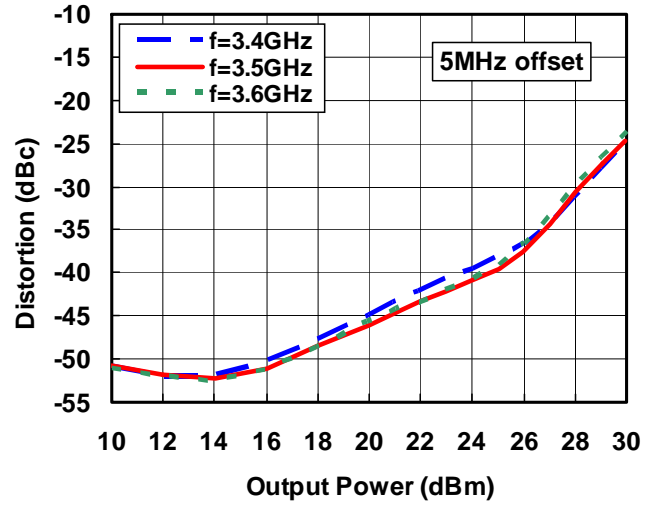
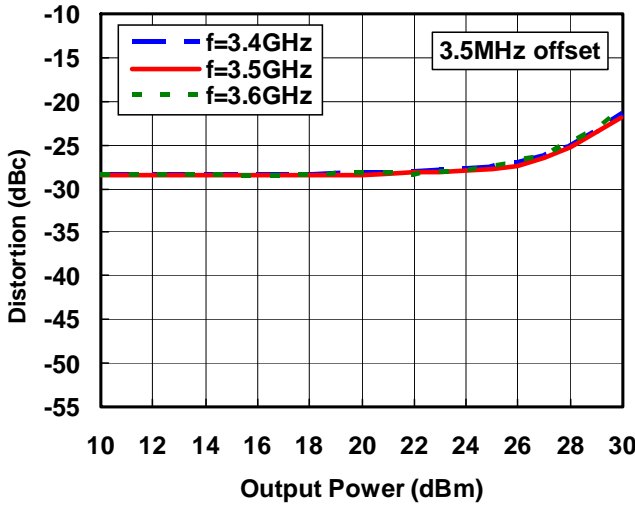

Spectrum Emission Mask

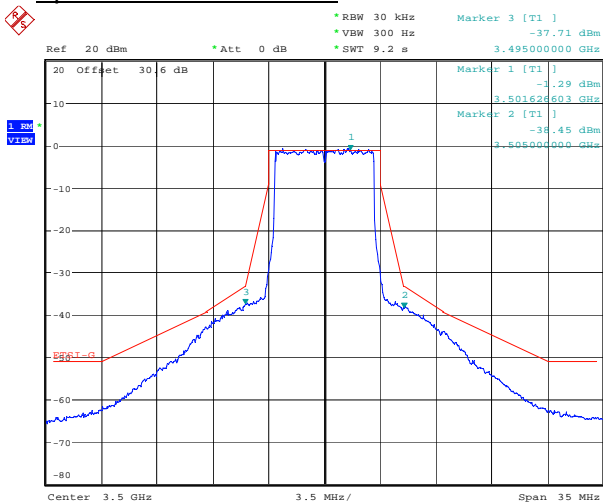

Pout(max.)=26dBm for EqC-EMO=6

Date: 20.DEC.2007 13:40:42

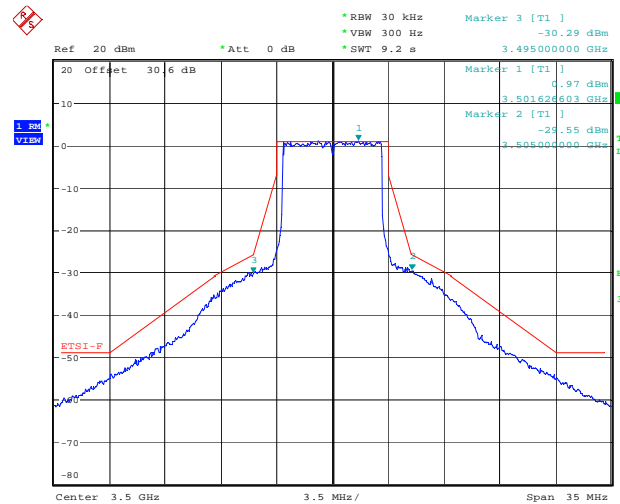

Pout(max.)=28dBm for EqC-EMO=4

Date: 20.DEC.2007 13:59:42

Specifications are subject to change without notice.

Vc=6V, Vref=2.85V, Vcont=0V, Duty Cycle=50%
 f=3.5GHz, WiMAX OFDM 64QAM signal input.

Output Power vs. Distortion

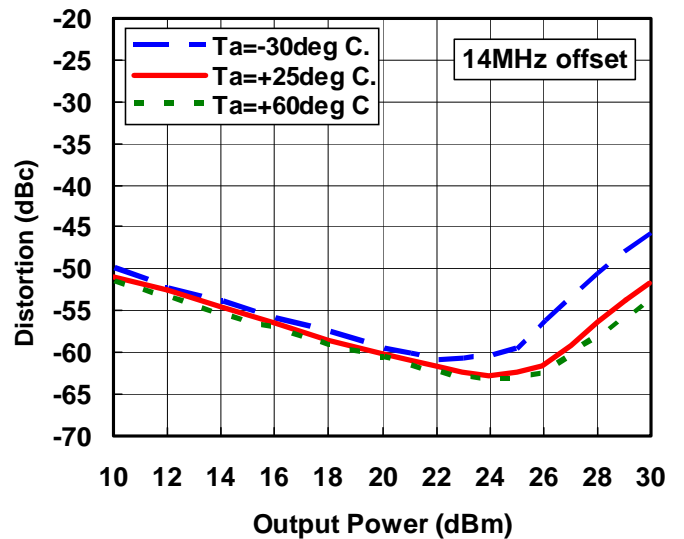
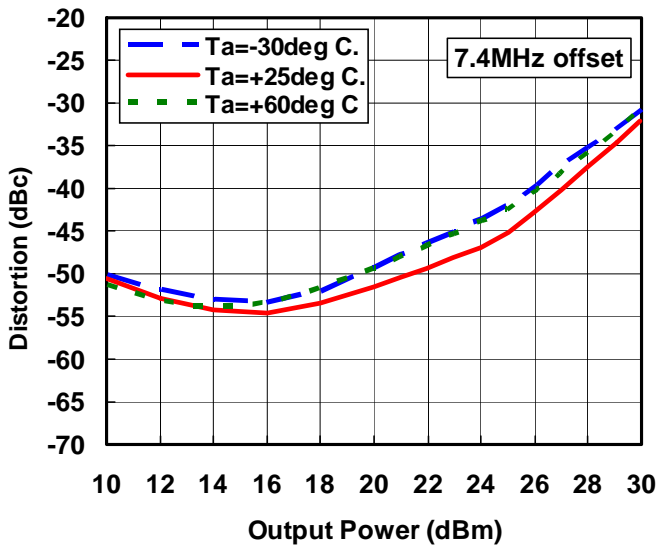
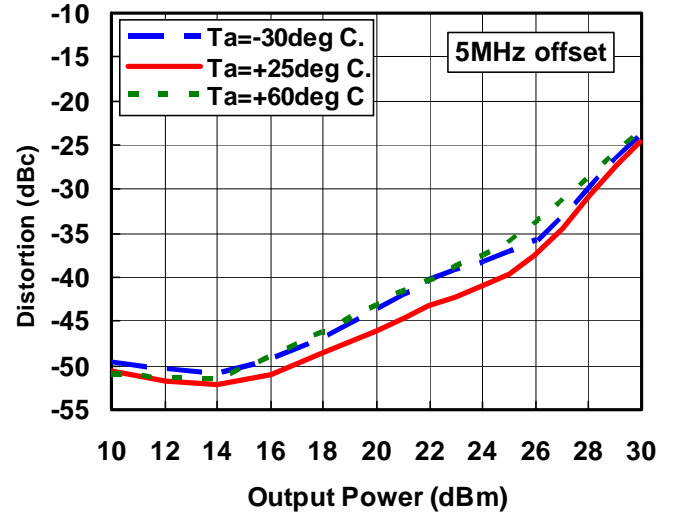
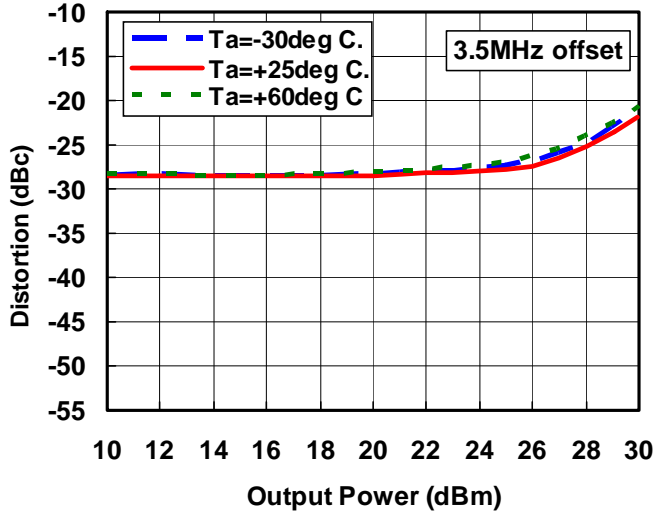

Specifications are subject to change without notice.

APPLICATION CIRCUIT

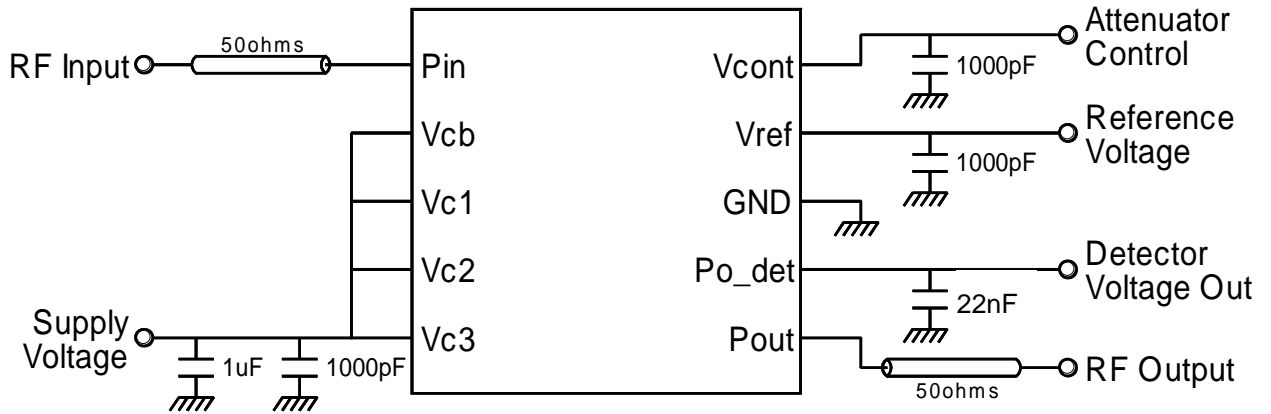

Pulse Operation is controlled by Vref

PACKAGE OUTLINE

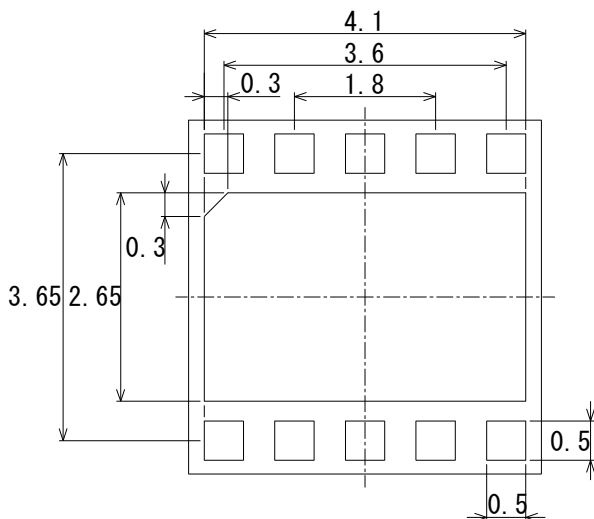
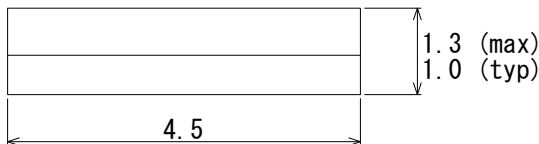
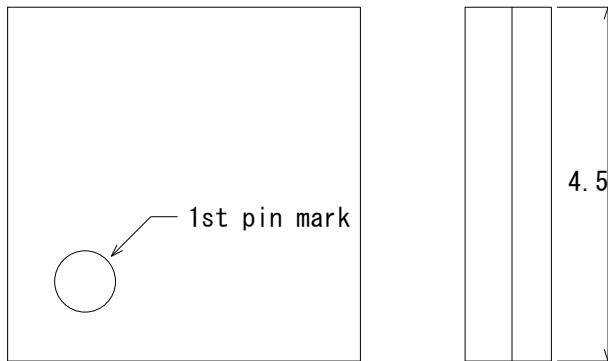

Dimension in millimeters.
Unless specified tolerance $\pm 0.2\text{mm}$.

Specifications are subject to change without notice.

HANDLING PRECAUTION

- 1) Work desk, test equipment, soldering iron and worker should be grounded before mounting and testing. Please note that electric discharge of GaAs HBT is much more sensitive than that of Si transistor. Handling without ground possibly damages GaAs HBT.
- 2) The surface of a board on which this product is mounted should be as flat and clean as possible to prevent a substrate from cracking by bending this product.
- 3) IR reflow soldering condition is confirmed following profile.

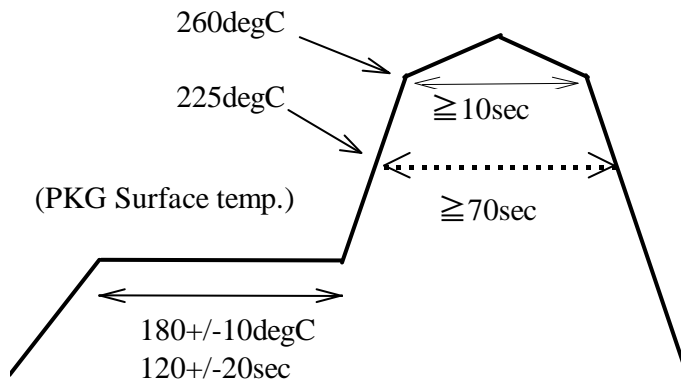

- 4) Handling precaution at high temperature
This product has the structure of sealing with epoxy resin on glass epoxy substrate. This epoxy resin gets soft if the temperature exceeds glass transition temperature=120degC, and the thermic decomposition is occurred if the temperature exceeds 350degC. Therefore, in case of heating this product, please keep the same heat profile as recommended reflow one.
Please note that crack, flaw or modification may be generated if softened epoxy resin part is handled with tweezers and etc at high temperature.
- 5) Cleaning condition
Please select after confirming administrative guidance, legal restrictions, and the mass of the residual ion contaminant etc., and use it.
- 6) After soldering, please remove the flux. Please take care that solvent does not penetrate into this product.
- 7) GaAs HBT contains As(Arsenic). This product should be dumped as particular industrial waste.