

# SPECIFICATION FOR APPROVAL

REF : 20080805-B

PAGE: 1

PROD. NAME	SHIELDED SMD POWER INDUCTOR	ABC'S DWG NO.	SU1028□□□□F□-□□□
		ABC'S ITEM NO.	

## I . CONFIGURATION & DIMENSIONS :

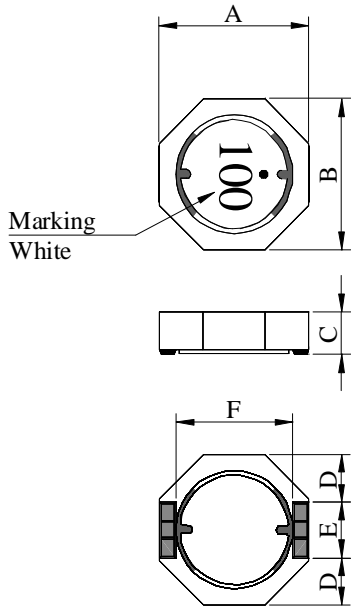

- A : 10.0 ±0.3 m/m
- B : 10.0 ±0.3 m/m
- C : 2.8 ±0.3 m/m
- D : 3.4 typ. m/m
- E : 3.2 typ. m/m
- F : 7.4 typ. m/m
- G : 4.0 ref. m/m
- H : 7.2 ref. m/m
- I : 1.8 ref. m/m

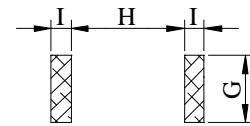

( PCB Pattern suggestion )

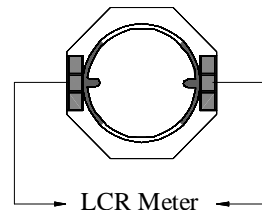

## II . SCHEMATIC DIAGRAM :



## III . MATERIALS :

- a . Core : Ferrite DR core
- b . Core : Ferrite RI core
- c . Wire : Enamelled copper wire ( Class F & H )
- d . Adhesive : Epoxy resin
- e . Terminal : Ag/Ni/ Sn
- f . Remark : Products comply with RoHS' requirements

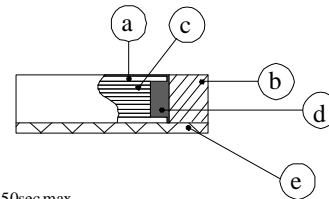

Peak Temp : 260°C max.  
 Max time above 230°C : 50sec max.  
 Max time above 200°C : 70sec max.

## IV . GENERAL SPECIFICATION :

- a . Temp. rise : 40°C max.
- b . Storage temp. : -40°C ----+125°C
- c . Operating temp. : -40°C ----+105°C
- d . Resistance to solder heat : 260°C.10 secs.

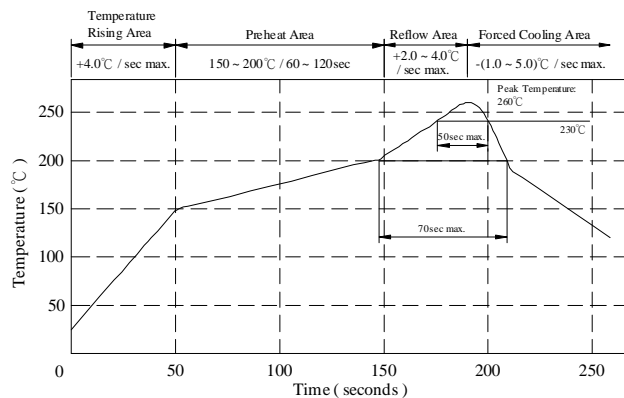

AR-001A

# SPECIFICATION FOR APPROVAL

PROD. NAME	SHIELDED SMD POWER INDUCTOR	ABC'S DWG NO.	SU1028□□□□F□-□□□
		ABC'S ITEM NO.	

**V . ELECTRICAL CHARACTERISTICS :**

DWG No.	Inductance ( μH )	Q ref.	SRF ( MHz ) typ.	RDC ( mΩ )		Irms ( A ) max.	Isat ( A ) typ.
				typ.	max.		
SU10281R0YF□-□□□	1.00 ± 30 %	14	100	4.9	6.5	7.00	8.00
SU10281R5YF□-□□□	1.50 ± 30 %	12	80	7.3	10.0	6.50	6.50
SU10282R2YF□-□□□	2.20 ± 30 %	12	65	11.0	15.0	5.30	4.80
SU10283R3YF□-□□□	3.30 ± 30 %	14	55	15.0	20.0	4.60	4.30
SU10284R7YF□-□□□	4.70 ± 30 %	12	40	16.5	23.0	4.50	3.80
SU10286R8YF□-□□□	6.80 ± 30 %	12	30	25.0	33.0	3.50	3.00
SU10288R2YF□-□□□	8.20 ± 30 %	12	28	28.5	37.0	3.30	2.70
SU1028100YF□-□□□	10.00 ± 30 %	20	25	40.0	53.0	2.80	2.40
SU1028150YF□-□□□	15.00 ± 30 %	26	22	69.0	90.0	2.00	2.00
SU1028220YF□-□□□	22.00 ± 30 %	26	16	104.0	135.0	1.60	1.40
SU1028330YF□-□□□	33.00 ± 30 %	24	12	139.0	180.0	1.25	1.20
SU1028470YF□-□□□	47.00 ± 30 %	20	11	167.0	230.0	1.30	1.10
SU1028560YF□-□□□	56.00 ± 30 %	22	10	208.0	270.0	1.10	1.00
SU1028680YF□-□□□	68.00 ± 30 %	20	9	232.0	300.0	1.00	0.90
SU1028820YF□-□□□	82.00 ± 30 %	20	8	323.0	420.0	0.90	0.85
SU1028101YF□-□□□	100.00 ± 30 %	20	7	365.0	470.0	0.85	0.80
SU1028121YF□-□□□	120.00 ± 30 %	18	6	428.0	560.0	0.65	0.70
SU1028151YF□-□□□	150.00 ± 30 %	18	5	518.0	680.0	0.70	0.65

- 1) . □ : Packaging Information... [A] : Bulk [B] : Taping Reel
- 2) ."- □□□":Reference code
- 3) . Inductance Test Freq. : 100KHz / 1V
- 4) . Q Test Freq. : 1R0~8R2--7.96MHz , 100~820--2.52MHz , 101~151--0.796MHz
- 5) . Isat base on ΔL / L0A=35% typ.
- 6) . Irms base on Temp. rise 40°C max.

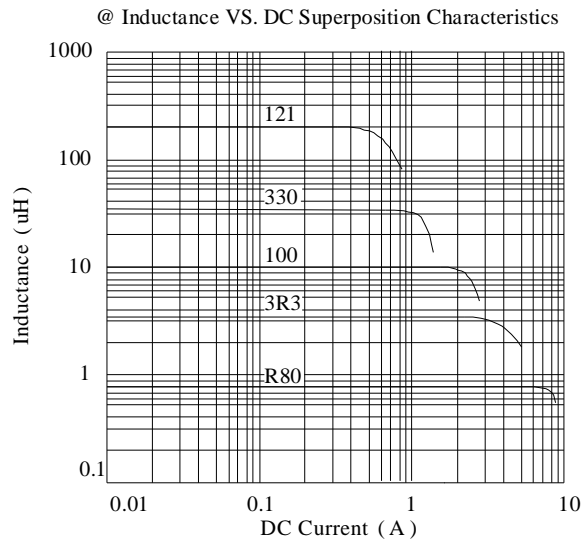

# SPECIFICATION FOR APPROVAL

REF : 20080805-B

PAGE: 3

PROD. NAME	SHIELDED SMD POWER INDUCTOR	ABC'S DWG NO.	SU1028□□□□F□-□□□
		ABC'S ITEM NO.	

## VI . PACKAGING INFORMATION :

### ( 1 ) Configuration

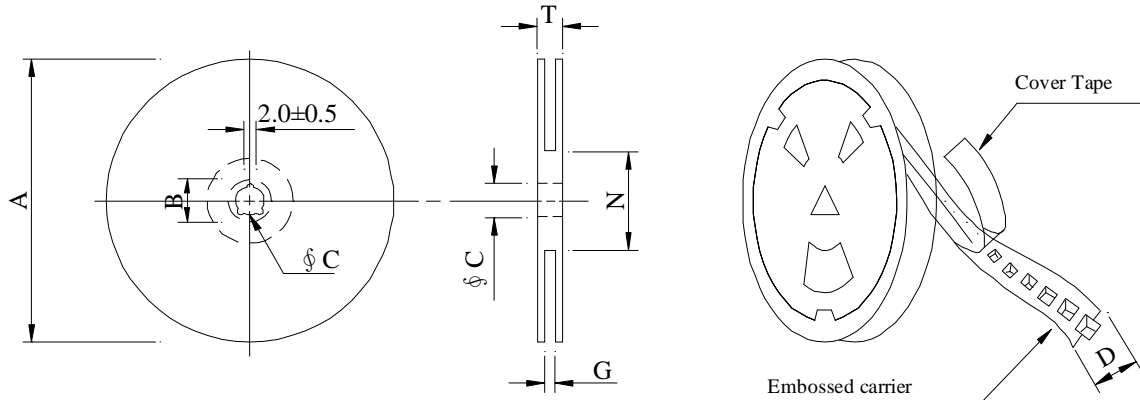

※Carrier tape width : D

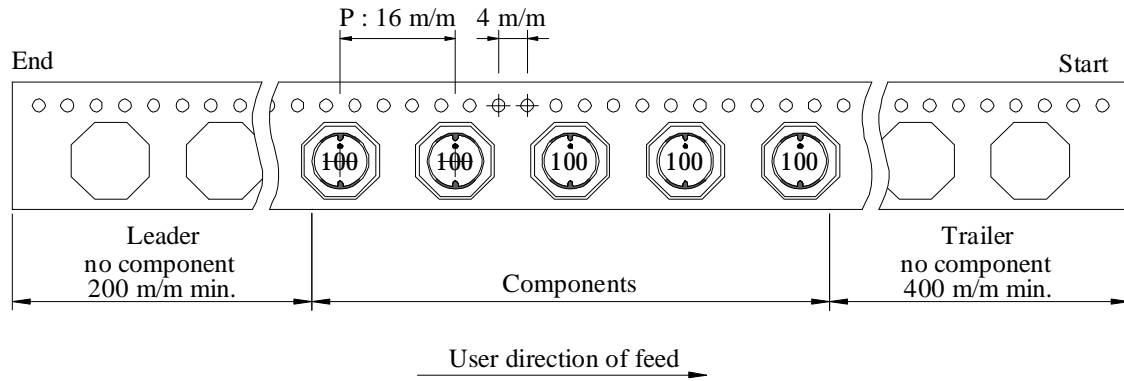

### ( 2 ) Dimensions

Unit:m/m

Style	A	B	C	D	G	N	T
13 - 24	330	21±0.8	13±0.5	24	26 <sup>+0</sup>	50 <sup>-0</sup>	30.4

### ( 3 ) Q'TY & G.W. Per package

Series	Inner : Reel			Outer : Carton		
	Q'TY (pcs)	G.W. (gw)	Style	Q'TY (pcs)	G.W. (Kg)	Size (cm)
SU1028	1000	1800	13 - 24	4000	8.0	40 x 40 x 24

AR-001A

# SPECIFICATION FOR APPROVAL

REF : 20080805-B

PAGE: 4

PROD. NAME	SHIELDED SMD POWER INDUCTOR	ABC'S DWG NO.	SU1028□□□□F□-□□□
		ABC'S ITEM NO.	

**VII . DWGING NUMBER EXPRESSION :**

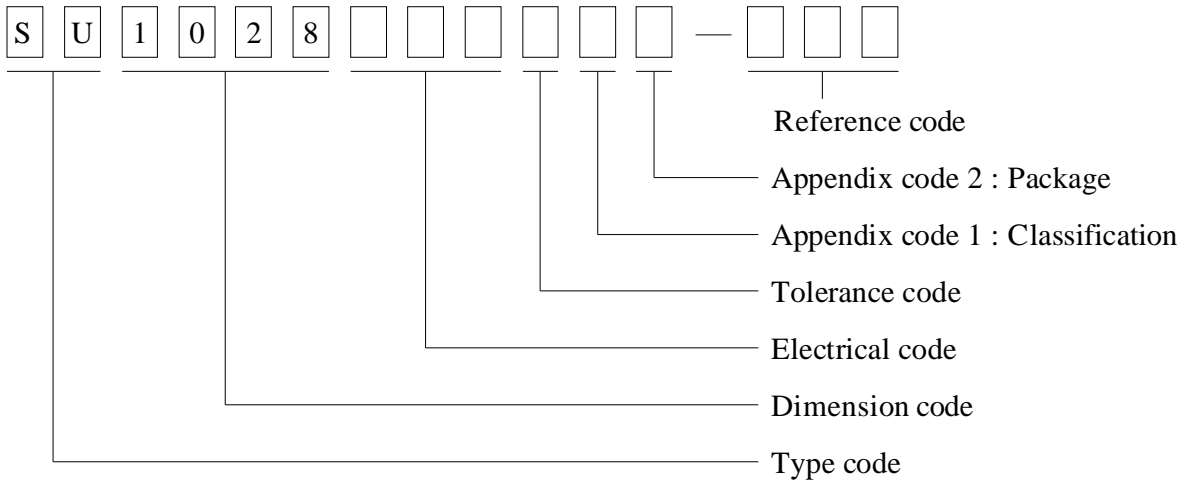

**Appendix code 1 : Product Classification**

- F : Lead Free Standard products comply with RoHS' requirements
- 1 ~ 9 : Lead Free Special products comply with RoHS' requirements

**Appendix code 2 : Package Information**

Code	Inner package	Inner package Q'TY	Remark
A	T.B.D.	T.B.D.	
B	T / R ( Reel package )	1,000 pcs	

# SPECIFICATION FOR APPROVAL

REF : 20080805-B

PAGE: 5

PROD. NAME	SHIELDED SMD POWER INDUCTOR	ABC'S DWG NO.	SU1028□□□□F□-□□□
		ABC'S ITEM NO.	

**VIII . RELIABILITY TEST :**

Test item	Specification	Test condition						
Solderability	More than 95% of the terminal electrode shall be covered With fresh solder.	Preheat : 155°C / 4 hours. Solder : Sn96.5 / Ag3 / Cu0.5 or equivalent Solder temp. : 235±5°C Flux : Rosin Dip time : 5±0.5 seconds						
Thermal shock test ( Temp. cycle )	Electrical oharacteristics shall not change more than ±20%	<table style="width: 100%; border: none;"> <tr> <td style="text-align: center;">Room temp. 15 minutes</td> <td style="text-align: center;">→</td> <td style="text-align: center;">-40 °C 30 minutes</td> </tr> <tr> <td style="text-align: center;">Room temp. 15 minutes</td> <td style="text-align: center;">→</td> <td style="text-align: center;">+105 °C 30 minutes</td> </tr> </table> <p>Total : 50 cycles</p>	Room temp. 15 minutes	→	-40 °C 30 minutes	Room temp. 15 minutes	→	+105 °C 30 minutes
Room temp. 15 minutes		→	-40 °C 30 minutes					
Room temp. 15 minutes		→	+105 °C 30 minutes					
Humidity test		Temperature : 40±2°C Humidity : 90±5% Time : 1000 hours						
High temp. Resistance test	Temperature : 105±5°C Applied current : Per spec. Time : 96 hours							

AR-001A





# SPECIFICATION FOR APPROVAL

REF :20080805-B

PAGE: 7

PROD. NAME	SHIELDED SMD POWER INDUCTOR	ABC'S DWG NO. ABC'S ITEM NO.	SU1028□□□□F□-□□□
---------------	--------------------------------	---------------------------------	------------------

OBMW2 August 27, 1999  
 Magnet Wire-Component

ELEKTRISOLA (MALAYSIA) SDN BHD E143312  
 IALAN DAMN SATU IANDA BAIK 28750 BENTONG, PAHANG  
 DARUL MAKMUR MALAYSIA

Mtl Dsg	Mark Dsg	Coating Type		ANSI Typ	Temp Class
		BC	OC		
Estersol 160	E180	Polyesterimide (solderable)	----	MW-77	180
Amldester 200	A200	Polyesterimide	----	MW-74	200
Polysol-N 155	PN155	Polyurethane	Nylon	MW-80, MW-28	155, 100
Polysol 155	P155	Polyurethane	----	MW-79, MW-79	155, 130
Polysol 155g	Pg155	Polyurethane	----	MW-79	130
Polysol 155p	Pp155,Gp155	Polyurethane	----	MW-79	155
Polysol 160	P160	Polyurethane	----	MW-79	155
Polysol 180	P180	Polyurethane	----	MW-79	155
Polysol 170	P170 or G170	Polyurethane	----	MW-79	156
Polysol-N 180	PN180	Polyurethane	Nylon	----	180

Marking : Company name/material designation or marked designation and factory identification on package ok reel

---

See General Information preceding These Recognitions  
 For use only in equipment where the acceptability of the combination is determined by Underwriters Laboratories Inc.

AR-001A

