

## FEATURES

- Plastic package has Underwriters Laboratory Flammability Classification 94V-0
- Metal silicon junction ,majority carrier conduction
- For surface mount applications
- Low power loss ,high efficiency
- High current capability ,Low forward voltage drop
- Low profile package
- built-in strain relief ,ideal for automated placement
- For use in low voltage ,high frequency inverters, free wheeling ,and polarity protection applications
- High temperature soldering guaranteed:260°C/10 seconds at terminals
- Component in accordance to RoHS 2002/95/EC and WEEE 2002/96/EC

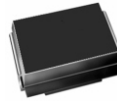

## SMB(DO-214AA)

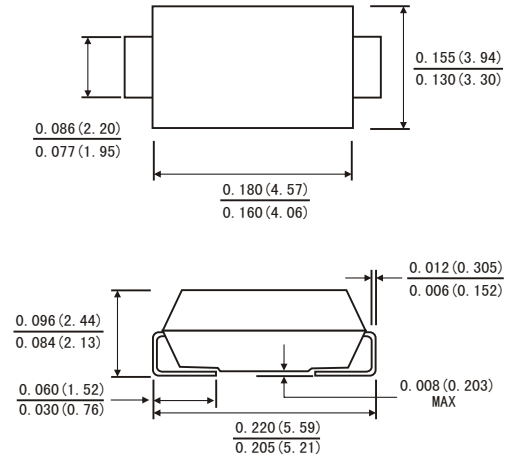

Dimensions in inches and (millimeters)

## MECHANICAL DATA

- Case: JEDEC SMB(DO-214AA) molded plastic body
- Terminals: solder plated ,solderable per MIL-STD-750,method 2026
- Polarity: color band denotes cathode end
- Weight: 0.003ounce,0.093 gram

## MAXIMUM RATINGS AND ELECTRICAL CHARACTERISTICS

(Ratings at 25°C ambient temperature unless otherwise specified ,Single phase ,half wave ,resistive or inductive load. For capacitive load,derate by 20%.)

	Symbols	SK 32	SK 33	SK 34	SK 35	SK 36	SK 38	SK 3A	Units
Maximum repetitive peak reverse voltage	V <sub>RRM</sub>	20	30	40	50	60	80	100	Volts
Maximum RMS voltage	V <sub>RMS</sub>	14	21	28	35	42	57	71	Volts
Maximum DC blocking voltage	V <sub>DC</sub>	20	30	40	50	60	80	100	Volts
Maximum average forward rectified current 0.375"(9.5mm) lead length (See Fig.1)	I(AV)	3.0							Amps
Peak forward surge current 8.3ms single half sine-wave superimposed on rated load (JEDEC method)	I <sub>FSM</sub>	80.0							Amps
Maximum instantaneous forward voltage at 3.0 A(Note 1)	V <sub>F</sub>	0.55		0.75		0.85		Volts	
Maximum instantaneous reverse current at rated DC blocking voltage(Note 1)	T <sub>a</sub> =25°C	0.5							mA
	T <sub>a</sub> =100°C	20		10					
Typical junction capacitance(Note 3)	C <sub>J</sub>	250			160			PF	
Typical thermal resistance (Note 2)	R <sub>θJA</sub>	55.0							°C/W
	R <sub>θJL</sub>	17.0							
Operating junction temperature range	T <sub>J</sub>	-65 to+125			-65 to+150			°C	
Storage temperature range	T <sub>STG</sub>	-65 to+150							°C

Notes: 1.Pulse test: 300 μs pulse width,1% duty cycle

2. P.C.B. mounted 0.55 X 0.55"(14 X 14mm)copper pad areas

3. Measured at 1MHz and reverse voltage of 4.0volts

# RATINGS AND CHARACTERISTIC CURVES SK32-SK3A

FIG.1-FORWARD CURRENT DERATING CURVE

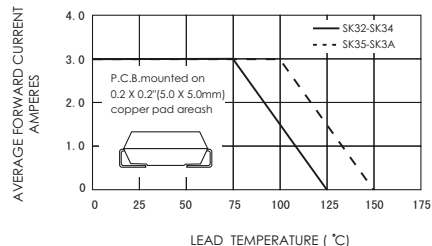

FIG.2-MAXIMUM NON-REPETITIVE PEAK FORWARD SURGE CURRENT

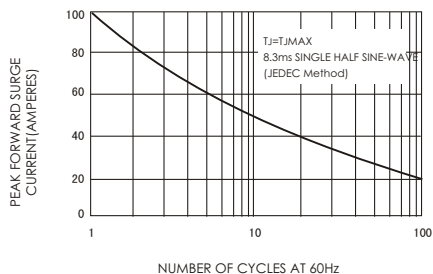

FIG.3-TYPICAL INSTANTANEOUS FORWARD CHARACTERISTICS

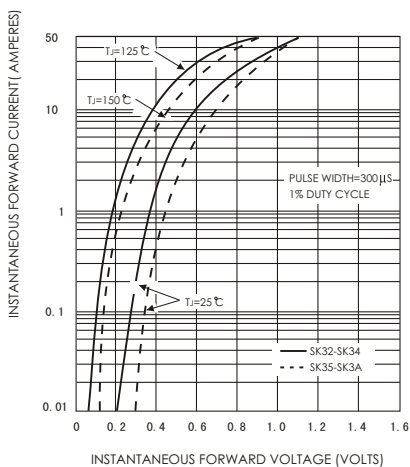

FIG.4-TYPICAL REVERSE CHARACTERISTICS

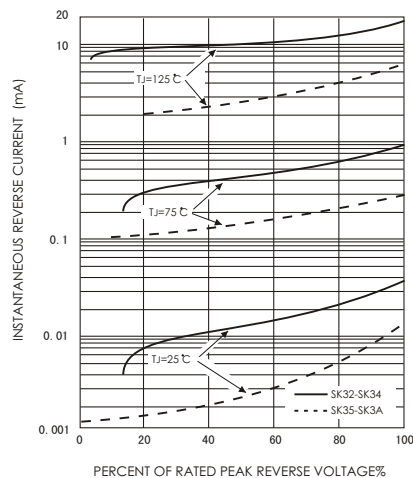

FIG.5-TYPICAL JUNCTION CAPACITANCE

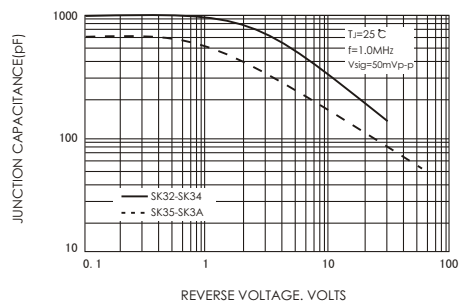

FIG.6-TYPICAL TRANSIENT THERMAL IMPEDANCE

