

**1310 nm Single-mode Transceiver (S1.1)**  
**1x9, SC Duplex Connector, 3.3 V**  
**155 Mbps ATM/SONET OC-3/SDH STM-1**



**Features**

- Compliant with 155 Mbps ATM and SONET OC-3 SDH STM-1 (S1.1)
- Industry standard 1×9 footprint
- SC duplex connector
- Single power supply 3.3 V
- Differential LVPECL inputs and outputs
- Compatible with solder and aqueous wash processes
- Class 1 laser product complies with EN 60825-1

**Description**

The TS3-0155-32S-P1-X transceivers utilizing 1310 nm MQW laser diodes are fully compliance to the 155 Mbps ATM and SONET OC-3 SDH STM-1 standard, and designed in industry standard 1×9 package with SC duplex connector. The transmitter section is a class 1 laser which is compliant to International Safety Standard EN 60825-1.

**Ordering Information**

| <i>PART NUMBER</i> | <i>INPUT/OUTPUT</i> | <i>SIGNAL DETECT</i> | <i>VOLTAGE</i> | <i>TEMPERATURE</i> |
|--------------------|---------------------|----------------------|----------------|--------------------|
| TS3-0155-32S-P1    | DC/DC               | LVPECL               | 3.3 V          | 0°C to 70°C        |
| TS3-0155-32S-P1-E  | DC/DC               | LVPECL               | 3.3 V          | -40°C to 85°C      |

**Absolute Maximum Ratings**

| <i>PARAMETER</i>      | <i>SYMBOL</i> | <i>MIN</i> | <i>MAX</i> | <i>UNITS</i> | <i>NOTE</i>         |
|-----------------------|---------------|------------|------------|--------------|---------------------|
| Storage Temperature   | $T_S$         | -40        | 85         | °C           |                     |
| Supply Voltage        | $V_{cc}$      | -0.5       | 6.0        | V            |                     |
| Input Voltage         | $V_{IN}$      | -0.5       | $V_{cc}$   | V            |                     |
| Output Current        | $I_o$         | ---        | 50         | mA           |                     |
| Operating Current     | $I_{OP}$      | ---        | 400        | mA           |                     |
| Soldering Temperature | $T_{SOLD}$    | ---        | 260        | °C           | 10 seconds on leads |



http:// www.ritekom.com

Version 3.3

Headquarters :  
 No. 669, Sec. 4 Chung Hsing Road  
 Chudung, HsinChu, Taiwan 310, ROC  
 Tel: +886-3-582-8270  
 Fax: +886-3-582-8416

**1310 nm Single-mode Transceiver (S1.1)**  
**1x9, SC Duplex Connector, 3.3 V**  
**155 Mbps ATM/SONET OC-3/SDH STM-1**



**Operating Environment**

| PARAMETER   | SYMBOL    | MIN | MAX | UNITS | NOTE |
|---|-----------|-----|-----|-------|------|
| Ambient Operating Temperature (TS3-0155-32S-P1)   | $T_{AMB}$ | 0   | 70  | °C    |      |
| Ambient Operating Temperature (TS3-0155-32S-P1-E) | $T_{AMB}$ | -40 | 85  | °C    |      |
| Supply Voltage                                    | $V_{CC}$  | 3.1 | 3.5 | V     |      |

**Transmitter Electro-optical Characteristics**

( $V_{CC} = 3.1 \text{ V to } 3.5 \text{ V}$ , TS3-0155-32S-P1:  $T_A = 0^\circ \text{C to } 70^\circ \text{C}$ , TS3-0155-32S-P1-E:  $T_A = -40^\circ \text{C to } 85^\circ \text{C}$ )

| PARAMETER   | SYMBOL  | MIN  | TYP. | MAX   | UNITS         | NOTE    |
|---|---|------|------|-------|---------------|---------|
| Data Rate   | $B$   | 50   | 155  | 200   | Mb/s          |         |
| Output Optical Power<br>9/125 $\mu\text{m}$ fiber | $P_{out}$   | -15  | ---  | -8    | dBm           | Average |
| Extinction Ratio                                  | $ER$  | 8.2  | ---  | ---   | dB            |         |
| Center Wavelength                                 | $\lambda_C$   | 1261 | 1310 | 1360  | nm            |         |
| Spectral Width (RMS)                              | $\Delta\lambda$   | ---  | ---  | 4     | nm            |         |
| Rise/Fall Time (10–90%)                           | $T_{r,f}$   | ---  | 1    | 2     | ns            |         |
| Output Eye  | Compliant with Telcordia GR-253-CORE Issue 3 and ITU-T recommendation G-957 |      |      |       |               |         |
| Power Supply Current                              | $I_{CC}$  | ---  | ---  | 140   | mA            | Note 1  |
| Data Input Current-Low                            | $I_{IL}$  | -350 | ---  | ---   | $\mu\text{A}$ |         |
| Data Input Current-High                           | $I_{IH}$  | ---  | ---  | 350   | $\mu\text{A}$ |         |
| Transmitter Data Input Voltage-High               | $V_{IH} - V_{CC}$   | -1.1 | ---  | -0.74 | V             | Note 2  |
| Transmitter Data Input Voltage-Low                | $V_{IL} - V_{CC}$   | -2.0 | ---  | -1.58 | V             | Note 2  |
| Transmitter Data Input Differential Voltage       | $V_{DIFF}$  | 0.3  | ---  | 1.6   | V             | Note 2  |

Note 1: Not including the terminations.

Note 2: These inputs are compatible with 10K, 10KH and 100K ECL and PECL input.



http://www.ritekom.com

Version 3.3

Headquarters :  
 No. 669, Sec. 4 Chung Hsing Road  
 Chudung, HsinChu, Taiwan 310, ROC  
 Tel: +886-3-582-8270  
 Fax: +886-3-582-8416

**1310 nm Single-mode Transceiver (S1.1)**  
**1x9, SC Duplex Connector, 3.3 V**  
**155 Mbps ATM/SONET OC-3/SDH STM-1**



**Receiver Electro-optical Characteristics**

( $V_{CC} = 3.1 \text{ V to } 3.5 \text{ V}$ , TS3-0155-32S-P1:  $T_A = 0^\circ \text{C to } 70^\circ \text{C}$ , TS3-0155-32S-P1-E:  $T_A = -40^\circ \text{C to } 85^\circ \text{C}$ )

| PARAMETER                                 | SYMBOL            | MIN  | TYP | MAX   | UNITS         | NOTE    |
|---|-------------------|------|-----|-------|---------------|---------|
| Data Rate                                 | $B$               | 50   | 155 | 200   | Mb/s          |         |
| Optical Input Power-maximum               | $P_{IN}$          | 0    | --- | ---   | dBm           | Note 1  |
| Optical Input Power-minimum (Sensitivity) | $P_{IN}$          | ---  | --- | -34   | dBm           | Note 1  |
| Operating Center Wavelength               | $\lambda_C$       | 1100 | --- | 1600  | nm            |         |
| Signal Detect-Asserted                    | $P_A$             | ---  | --- | -34   | dBm           | Average |
| Signal Detect-Deasserted                  | $P_D$             | -47  | --- | ---   | dBm           | Average |
| Signal Detect-Hysteresis                  | $P_A - P_D$       | 1.0  | --- | ---   | dB            |         |
| Signal Detect Assert Time                 | $T_{SD+}$         | ---  | --- | 100   | $\mu\text{s}$ |         |
| Signal Detect Dessert Time                | $T_{SD-}$         | ---  | --- | 100   | $\mu\text{s}$ |         |
| Signal Detect Output voltage-High         | $V_{OH} - V_{CC}$ | -1.1 | --- | -0.74 | V             | Note 2  |
| Signal Detect Output voltage-Low          | $V_{OL} - V_{CC}$ | -2.0 | --- | -1.58 | V             | Note 2  |
| Power Supply Current                      | $I_{CC}$          | ---  | --- | 100   | mA            | Note 3  |
| Data Output Rise, Fall Time (10–90%)      | $T_{r,f}$         | ---  | 1   | 2     | ns            |         |
| Data Output Voltage-High                  | $V_{OH} - V_{CC}$ | -1.1 | --- | -0.74 | V             | Note 2  |
| Data Output Voltage-Low                   | $V_{OL} - V_{CC}$ | -2.0 | --- | -1.58 | V             | Note 2  |

Note 1: The input data is at 155.52 Mbps,  $2^{23}-1$  PRBS data pattern with 72 “1”s and 72 “0”s inserted per the ITU-T recommendation G958 Appendix 1. The receiver is guaranteed to provide output data with Bit Error Rate (BER) better than or equal to  $1 \times 10^{-10}$ .

Note 2: These outputs are compatible with 10K, 10KH and 100K ECL and PECL input.

Note 3: The current exclude the output load current.



http:// www.ritekom.com

Version 3.3

Headquarters :  
 No. 669, Sec. 4 Chung Hsing Road  
 Chudung, HsinChu, Taiwan 310, ROC  
 Tel: +886-3-582-8270  
 Fax: +886-3-582-8416

**1310 nm Single-mode Transceiver (S1.1)**  
**1x9, SC Duplex Connector, 3.3 V**  
**155 Mbps ATM/SONET OC-3/SDH STM-1**



**Block Diagram of Transceiver**

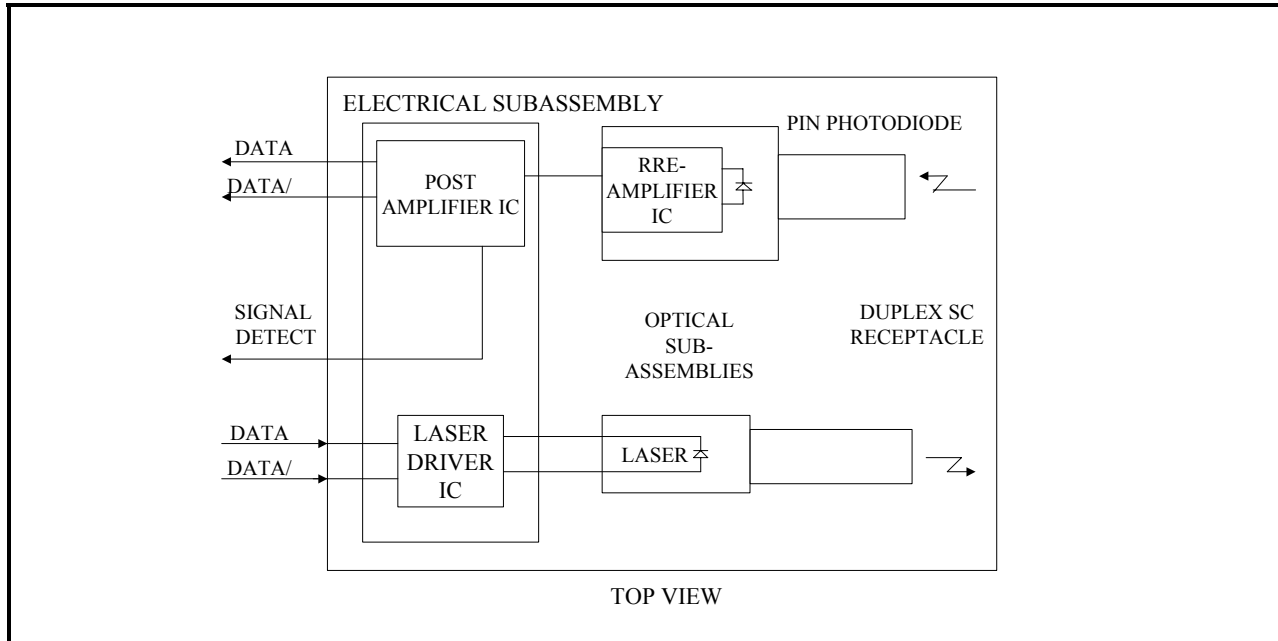

**Transmitter Section**

The transmitter section consists of a 1310 nm InGaAsP laser in an eye safe optical subassembly (OSA) which mates to the fiber cable. The laser OSA is driven by a LD driver IC which converts differential input LVPECL logic signals into an analog laser driving current.

**Receiver Section**

The receiver utilizes an InGaAs PIN photodiode mounted together with a trans-impedance preamplifier IC in an OSA. This OSA is connected to a circuit providing post-amplification quantization, and optical signal detection.

**Receiver Signal Detect**

Signal Detect is a basic fiber failure indicator. This is a single-ended LVPECL output. As the input optical power is decreased, Signal Detect will switch from high to low (deassert point) somewhere between sensitivity and the no light input level. As the input optical power is increased from very low levels, Signal Detect will switch back from low to high (assert point). The assert level will be at least 1.0 dB higher than the deassert level.



[http:// www.ritekom.com](http://www.ritekom.com)

Version 3.3

Headquarters :  
 No. 669, Sec. 4 Chung Hsing Road  
 Chudung, HsinChu, Taiwan 310, ROC  
 Tel: +886-3-582-8270  
 Fax: +886-3-582-8416

**1310 nm Single-mode Transceiver (S1.1)**  
**1x9, SC Duplex Connector, 3.3 V**  
**155 Mbps ATM/SONET OC-3/SDH STM-1**



**Typical BER Performance of Receiver versus Input Optical Power Level**

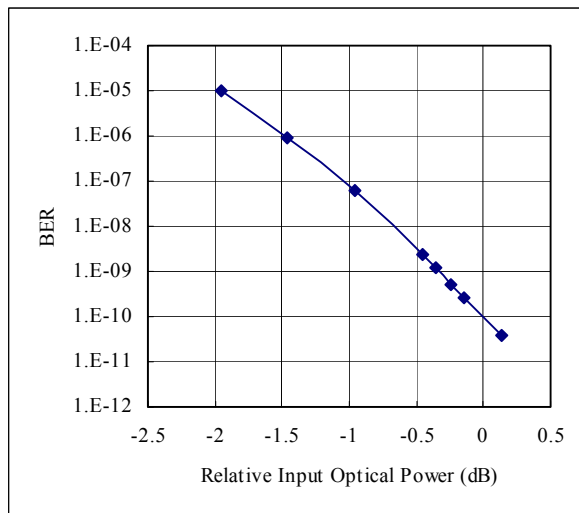

The figure shows the relationship between typical trade-off of BER and Relative Input Optical Power. Besides the required BER =  $1 \times 10^{-10}$  of the ATM Forum 155.52 Mbps Physical Layer Standard, The transceiver can be operated at other Bit-Error-Rate conditions. The Relative Input Optical Power in dB is referenced to the actual sensitivity of the device. For BER conditions better than  $1 \times 10^{-10}$ , more input signal is needed (+dB).

**Eye Diagram**

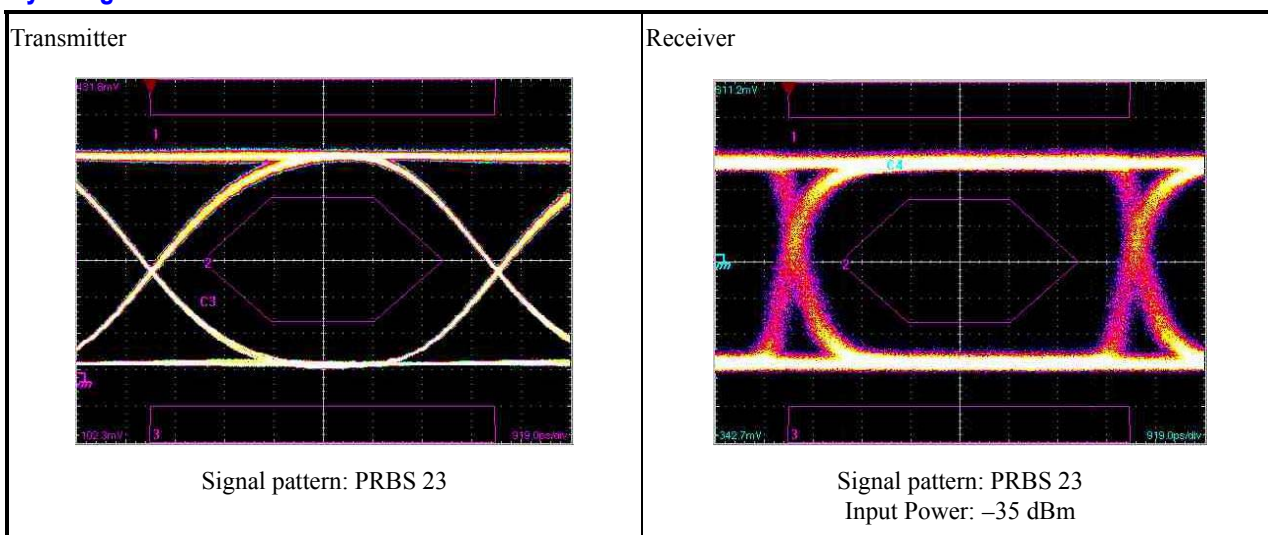

**1310 nm Single-mode Transceiver (S1.1)**  
**1x9, SC Duplex Connector, 3.3 V**  
**155 Mbps ATM/SONET OC-3/SDH STM-1**



**Connection Diagram**

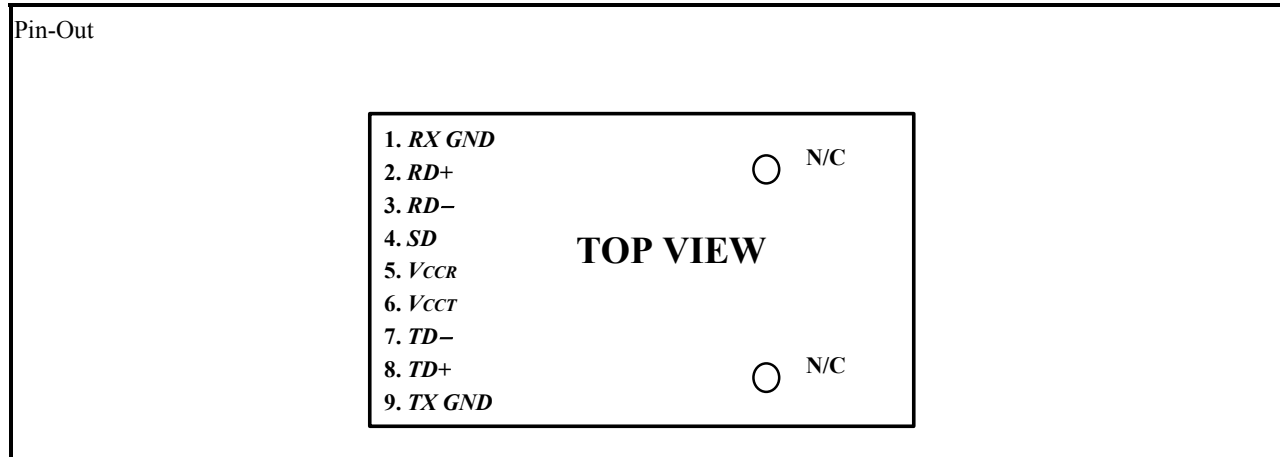

| PIN | SYMBOL                 | DESCRIPTION  |
|-----|------------------------|--|
| 1   | <i>RX GND</i>          | Receiver Signal Ground.<br>Directly connect this pin to the receiver ground plane.   |
| 2   | <i>RD+</i>             | <i>RD+</i> is an open-emitter output circuit.<br>Terminate this high-speed differential LVPECL output with standard LVPECL techniques at the follow-on device input pin. (See recommended circuit schematic)   |
| 3   | <i>RD-</i>             | <i>RD-</i> is an open-emitter output circuit.<br>Terminate this high-speed differential LVPECL output with standard LVPECL techniques at the follow-on device input pin. (See recommended circuit schematic)   |
| 4   | <i>SD</i>              | Signal Detect.<br>Normal optical input levels to the receiver result in a logic “1” output, $V_{OH}$ , asserted. Low input optical levels to the receiver result in a fault condition indicated by a logic “0” output $V_{OL}$ , deasserted. Signal Detect is a single-ended LVPECL output. <i>SD</i> can be terminated with LVPECL techniques via $50 \Omega$ to $V_{CCR} - 2 \text{ V}$ . Alternatively, <i>SD</i> can be loaded with a $180 \Omega$ resistor to <i>RX GND</i> to conserve electrical power with small compromise to signal quality. If Signal Detect output is not used, leave it open-circuited. This Signal Detect output can be used to drive a LVPECL input on an upstream circuit, such as, Signal Detect input or Loss of Signal-bar. |
| 5   | <i>V<sub>CCR</sub></i> | Receiver Power Supply.<br>Provide +3.3 Vdc via the recommended receiver power supply filter circuit. Locate the power supply filter circuit as close as possible to the <i>V<sub>CCR</sub></i> pin.  |
| 6   | <i>V<sub>CCT</sub></i> | Transmitter Power Supply.<br>Provide +3.3 Vdc via the recommended transmitter power supply filter circuit. Locate the power supply filter circuit as close as possible to the <i>V<sub>CCT</sub></i> pin.  |
| 7   | <i>TD-</i>             | Transmitter Data In-Bar.<br>Terminate this high-speed differential LVPECL input with standard LVPECL techniques at the transmitter input pin. (See recommended circuit schematic)  |
| 8   | <i>TD+</i>             | Transmitter Data In.<br>Terminate this high-speed differential LVPECL input with standard LVPECL techniques at the transmitter input pin. (See recommended circuit schematic)  |
| 9   | <i>TX GND</i>          | Transmitter Signal Ground.<br>Directly connect this pin to the transmitter signal ground plane. Directly connect this pin to the transmitter ground plane.   |





**1310 nm Single-mode Transceiver (S1.1)**  
**1x9, SC Duplex Connector, 3.3 V**  
**155 Mbps ATM/SONET OC-3/SDH STM-1**



**Recommended Board Layout Hole Pattern**

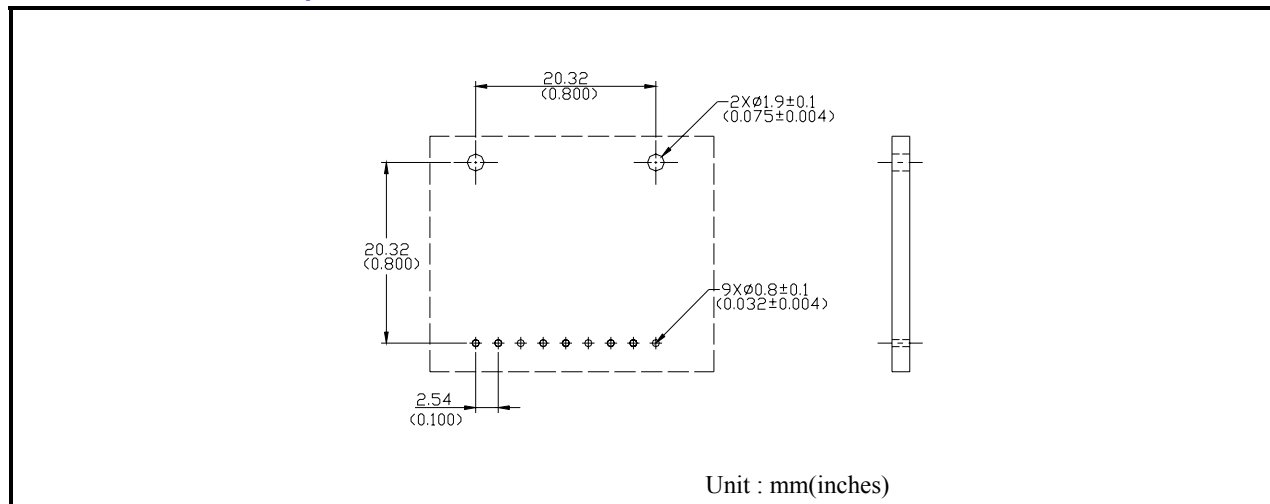

This transceiver is compatible with industry standard wave or hand solder processes. After wash process, all moisture must be completely remove from the module. The transceiver is supplied with a process plug to prevent contamination during wave solder and aqueous rinse as well as during handling, shipping or storage.

Solder fluxes should be water-soluble, organic solder fluxes. Recommended cleaning and degreasing chemicals for these transceivers are alcohol's (methyl, isopropyl, isobutyl), aliphatics (hexane, heptane) and other chemicals, such as soap solution or naphtha. Do not use partially halogenated hydrocarbons for cleaning/degreasing.



[http:// www.ritekom.com](http://www.ritekom.com)

Version 3.3

Headquarters :  
No. 669, Sec. 4 Chung Hsing Road  
Chudung, HsinChu, Taiwan 310, ROC  
Tel: +886-3-582-8270  
Fax: +886-3-582-8416



**1310 nm Single-mode Transceiver (S1.1)**  
**1x9, SC Duplex Connector, 3.3 V**  
**155 Mbps ATM/SONET OC-3/SDH STM-1**



**Drawing Dimensions**

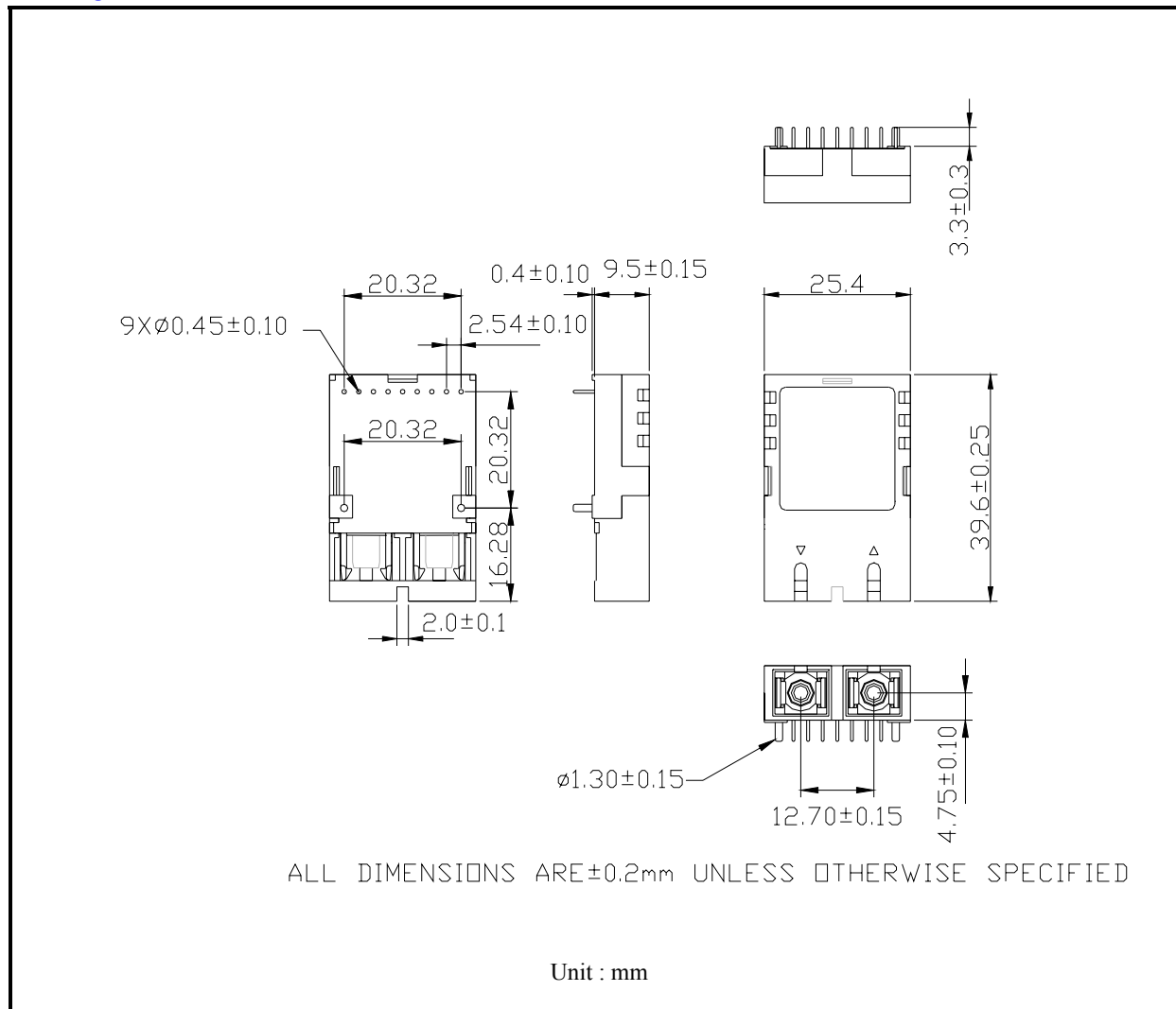

**1310 nm Single-mode Transceiver (S1.1)**  
**1x9, SC Duplex Connector, 3.3 V**  
**155 Mbps ATM/SONET OC-3/SDH STM-1**



**Regulatory Compliance**

| <i>FEATURE</i>                                       | <i>TEST METHOD</i>   | <i>PERFORMANCE</i>   |
|--|--|--|
| Electrostatic discharge (ESD) to the electrical pins | MIL-STD-883D Method 3015.7   | Class 1(>1 kV) – Human Body Model  |
| Electromagnetic interference (EMI)                   | FCC Class B<br>EN55022 Class B   | The transceiver is mounded on a circuit card without a chassis enclosure at frequencies up to 1000 MHz. Margins will be dependent on customer's board and chassis designs. |
| Immunity   | Variation of IEC801-3  | Typically show no measurable effect from a 10 V/m filed swept from 30 MHz to 1000 MHz applied to the transceiver without a chassis enclosure.                              |
| Eye safety   | FDA 21 CFR 1040.10 and 1040.11<br>Class 1                                    | FDA Accession Number: 0012715-01   |
|  | EN 60825-1:1994+A11<br>EN 60950: 1992+A1+A2+A3+A4+A11<br>EN 60825-2: 1994+A1 | TUV certificated Number: R 3-50005227  |

**Eye Safety Mark**

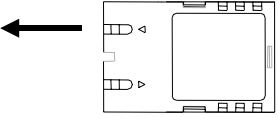
|   |  |
|---|--|
| <p>The TS3 series Single-mode transceiver is a class 1 laser product. It complies with EN 60825-1 and FDA 21 CFR 1040.10 and 1040.11. In order to meet laser safety requirements the transceiver shall be operated within the Absolute Maximum Ratings.</p> <p><b><u>Caution</u></b><br/> <b>All adjustments have been done at the factory before the shipment of the devices. No maintenance and user serviceable part is required. Tampering with and modifying the performance of the device will result in voided product warranty.</b></p> | <p><b><u>Required Mark</u></b></p> <div style="border: 1px solid black; padding: 5px; text-align: center;"> <p><b>Class 1 Laser Product<br/>Complies with<br/>21 CFR 1040.10 and 1040.11</b></p> </div> <p><b><u>Laser Emission</u></b></p> <p>Indication of Laser Aperture and Beam</p>  |
|---|--|

Note : All information contained in this document is subject to change without notice.



http:// www.ritekom.com

Version 3.3

Headquarters :  
 No. 669, Sec. 4 Chung Hsing Road  
 Chudung, HsinChu, Taiwan 310, ROC  
 Tel: +886-3-582-8270  
 Fax: +886-3-582-8416