

### IGBT Module

PSII 30/12\*

$I_{C80} = 33 \text{ A}$   
 $V_{CES} = 1200 \text{ V}$   
 $V_{CE(sat)typ.} = 3.1 \text{ V}$

Short Circuit SOA Capability  
 Square RBSOA

Preliminary Data Sheet

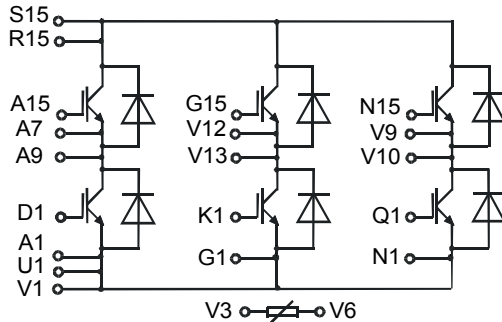

### ECO-TOP™ 1

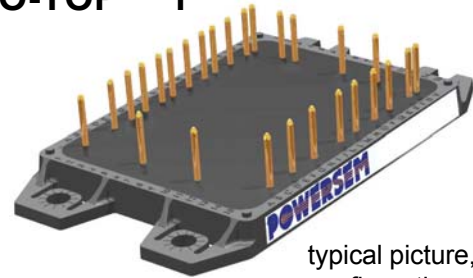

typical picture, for pin configuration see outline drawing

### IGBTs

Symbol	Conditions	Maximum Ratings	
$V_{CES}$	$T_{VJ} = 25^\circ\text{C to } 150^\circ\text{C}$	1200	V
$V_{GES}$		$\pm 20$	V
$I_{C25}$	$T_C = 25^\circ\text{C}$	49	A
$I_{C80}$	$T_C = 80^\circ\text{C}$	33	A
$I_{CM}$ $V_{CEK}$	$V_{GE} = \pm 15 \text{ V}; R_G = 47 \Omega; T_{VJ} = 125^\circ\text{C}$ RBSOA, Clamped inductive load; $L = 100 \mu\text{H}$	50	A
		$V_{CES}$	
$t_{SC}$ (SCSOA)	$V_{CE} = V_{CES}; V_{GE} = \pm 15 \text{ V}; R_G = 47 \Omega; T_{VJ} = 125^\circ\text{C}$ non-repetitive	10	$\mu\text{s}$
$P_{tot}$	$T_C = 25^\circ\text{C}$	208	W

\*NTC optional

Symbol	Conditions	Characteristic Values ( $T_{VJ} = 25^\circ\text{C}$ , unless otherwise specified)		
		min.	typ.	max.
$V_{CE(sat)}$	$I_C = 50 \text{ A}; V_{GE} = 15 \text{ V}; T_{VJ} = 25^\circ\text{C}$ $T_{VJ} = 125^\circ\text{C}$	3.1	3.7	V
			3.5	V
$V_{GE(th)}$	$I_C = 1 \text{ mA}; V_{GE} = V_{CE}$	4.5		6.5 V
$I_{CES}$	$V_{CE} = V_{CES}; V_{GE} = 0 \text{ V}; T_{VJ} = 25^\circ\text{C}$ $T_{VJ} = 125^\circ\text{C}$			1.1 mA 4.2 mA
$I_{GES}$	$V_{CE} = 0 \text{ V}; V_{GE} = \pm 20 \text{ V}$			180 nA
$t_{d(on)}$ $t_r$ $t_{d(off)}$ $t_f$	Inductive load, $T_{VJ} = 125^\circ\text{C}$ $V_{CE} = 600 \text{ V}; I_C = 30 \text{ A}$ $V_{GE} = 15/0 \text{ V}; R_G = 47 \Omega$	100		ns
		70		ns
		500		ns
		70		ns
$E_{on}$ $E_{off}$		4.6 3.4		mJ mJ
$C_{ies}$	$V_{CE} = 25 \text{ V}; V_{GE} = 0 \text{ V}; f = 1 \text{ MHz}$	1.65		nF
$R_{thJC}$ $R_{thJH}$	(per IGBT) with heatsink compound ( $0.42 \text{ K/m.K}; 50 \mu\text{m}$ )		0.6	K/W K/W

### Features

- Package with DCB ceramic base plate
- Isolation voltage 3000 V~
- Planar glass passivated chips
- Low forward voltage drop
- Leads suitable for PC board soldering
- UL Release applied

### Applications

- AC and DC motor control
- AC servo and robot drives
- Power supplies
- Welding inverters

### Advantages

- Easy to mount with four screws
- Space and weight savings
- Improved temperature and power cycling capability
- High power density
- Small and light weight

**Caution:** These Devices are sensitive to electrostatic discharge. Users should observe proper ESD handling precautions.

## Reverse diodes (FRED)

Symbol	Conditions	Maximum Ratings	
$I_{F25}$	$T_C = 25^\circ\text{C}$	49	A
$I_{F80}$	$T_C = 80^\circ\text{C}$	30	A

Symbol	Conditions	Characteristic Values		
		min.	typ.	max.
$V_F$	$I_F = 30\text{ A}; T_{VJ} = 25^\circ\text{C}$ $T_{VJ} = 125^\circ\text{C}$	2.4	2.7	V
		1.77		V
$I_{RM}$ $t_{rr}$	$I_F = 30\text{ A}; di_F/dt = 500\text{ A}/\mu\text{s}; T_{VJ} = 125^\circ\text{C}$ $V_R = 600\text{ V}; V_{GE} = 0\text{ V}$	27		A
		150		ns
$R_{thJC}$ $R_{thJH}$	with heatsink compound (0.42 K/m.K; 50 $\mu\text{m}$ )	2.6		1.3 K/W K/W

## Temperature Sensor NTC

Symbol	Conditions	Characteristic Values		
		min.	typ.	max.
$R_{25}$	$T = 25^\circ\text{C}$	4.75	5.0	5.25 k $\Omega$
$B_{25/50}$			3375	K

## Module

Symbol	Conditions	Maximum Ratings	
$T_{VJ}$		-40...+125	$^\circ\text{C}$
$T_{stg}$		-40...+150	$^\circ\text{C}$
$V_{ISOL}$	$I_{ISOL} \leq 1\text{ mA}; 50/60\text{ Hz}$	3000	V~
$M_d$	Mounting torque (M5)	3	Nm
		26	lb.in.
a	Max. allowable acceleration	50	$\text{m/s}^2$

Symbol	Conditions	Characteristic Values		
		min.	typ.	max.
$d_s$	Creepage distance on surface (Pin to heatsink)	11.2		mm
$d_A$	Strike distance in air (Pin to heatsink)	11.2		mm
Weight		86		g

## Package style and outline

Dimensions in mm (1mm = 0.0394")

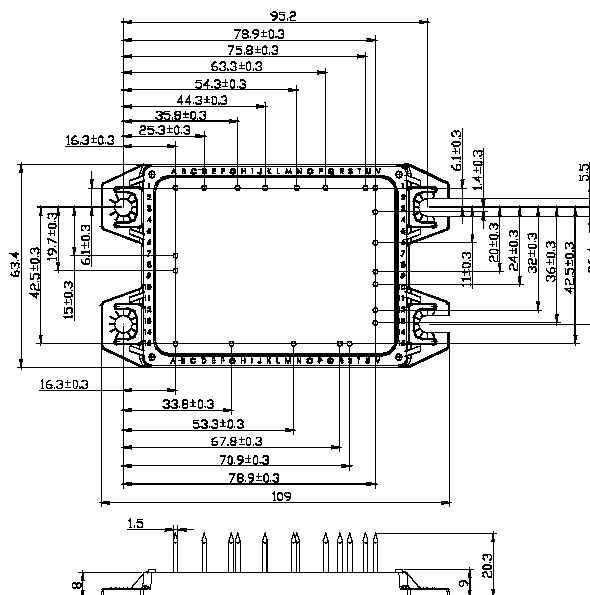

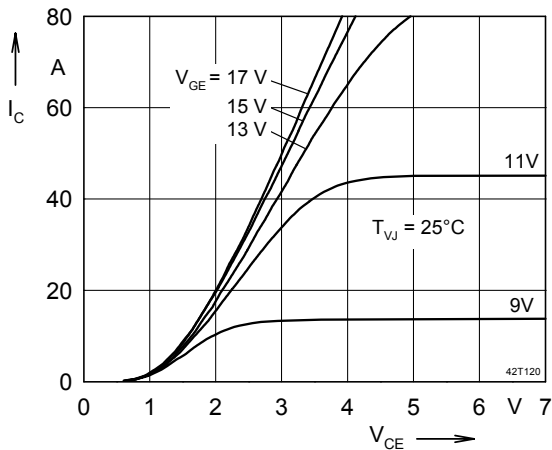

Fig. 1 Typ. output characteristics

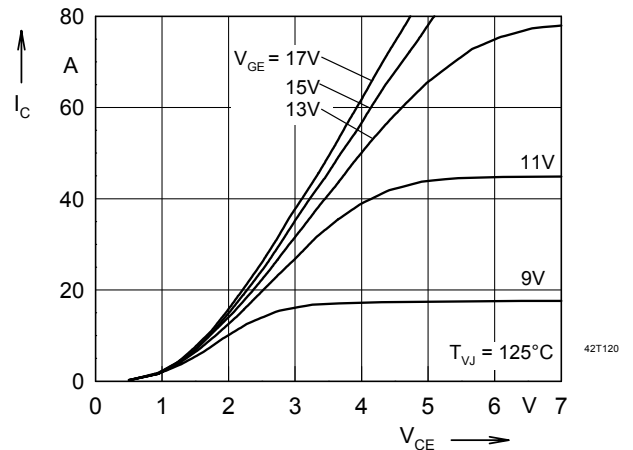

Fig. 2 Typ. output characteristics

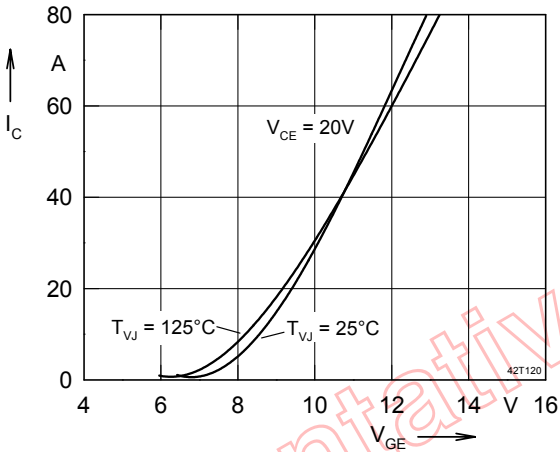

Fig. 3 Typ. transfer characteristics

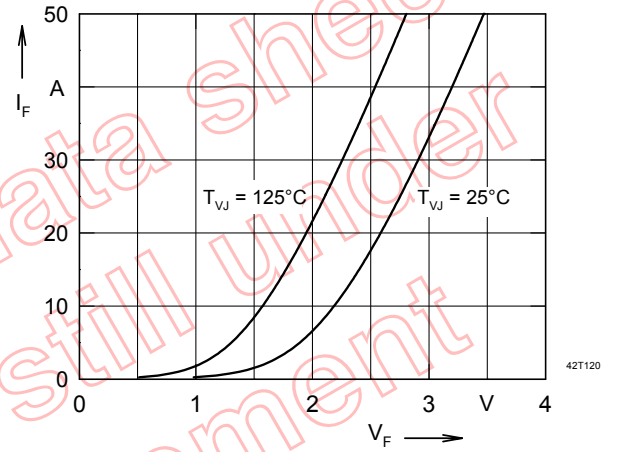

Fig. 4 Typ. forward characteristics of free wheeling diode

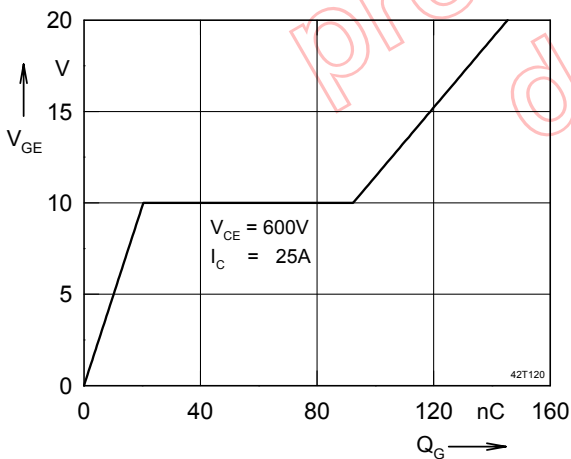

Fig. 5 Typ. turn on gate charge

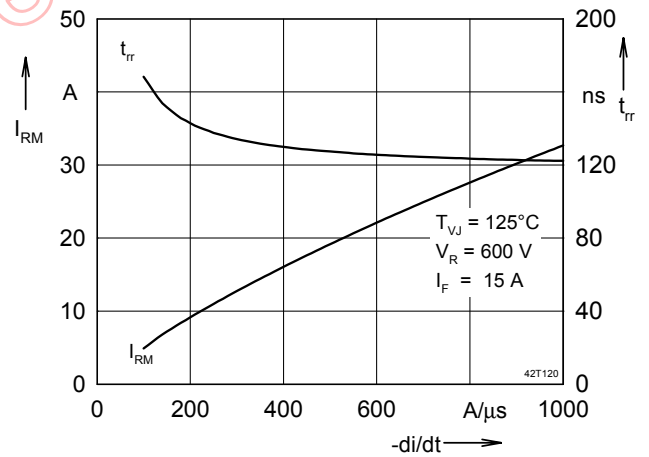

Fig. 6 Typ. turn off characteristics of free wheeling diode

