

BH-25 COIN CELL BATTERY HOLDER

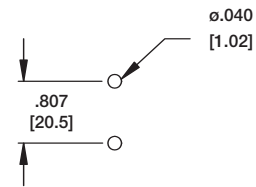

Recommended PCB Layout

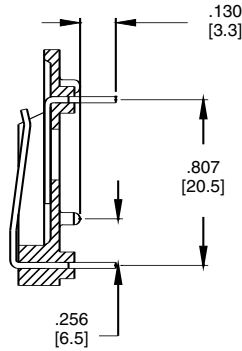
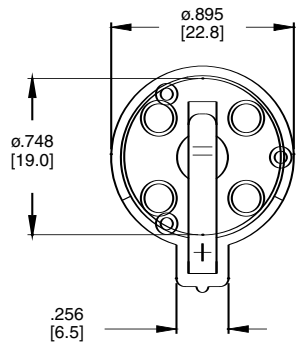
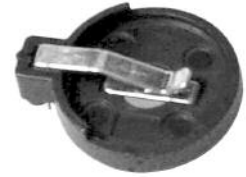

BH-25-1

BH-26 COIN CELL BATTERY HOLDER

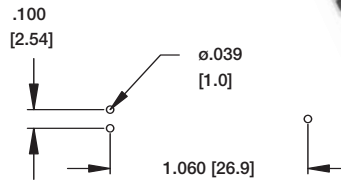
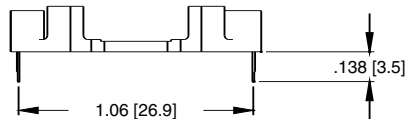
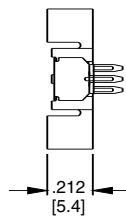
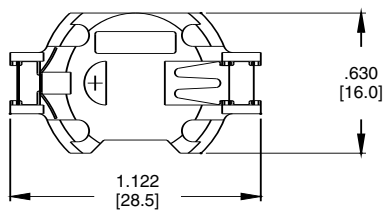

Recommended PCB Layout



BH-26-1

BH-27 COIN CELL BATTERY HOLDER

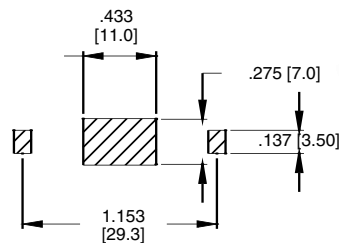
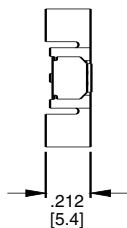
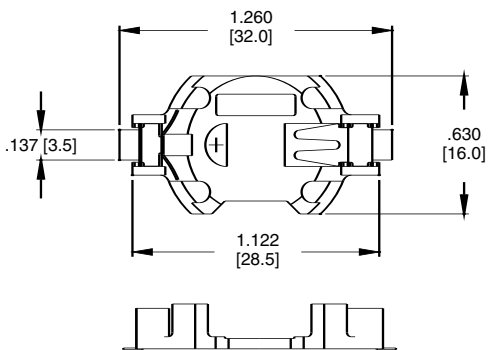

Recommended PCB Layout



BH-27-5