



LIGITEK ELECTRONICS CO.,LTD.
Property of Ligitek Only

SURFACE MOUNT LED TAPE AND REEL



Lead-Free Parts

LHYS9553

DATA SHEET

DOC. NO : QW0905- LHYS9553

REV. : A

DATE : 27 - Dec. - 2005



Package Dimensions

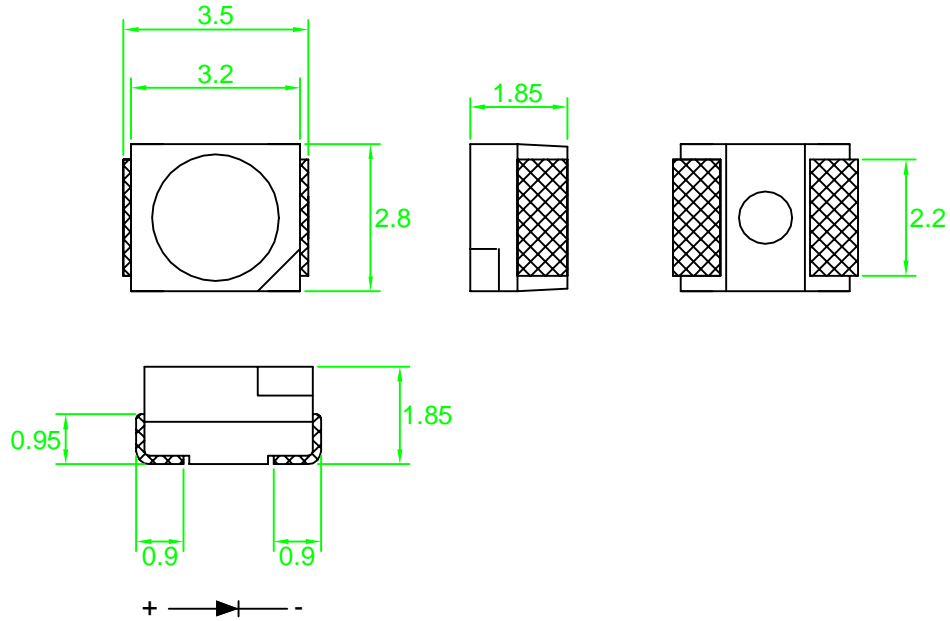

Note : 1.All dimension are in millimeter tolerance is $\pm 0.25\text{mm}$ unless otherwise noted.
2.Specifications are subject to change without notice.

Directivity Radiation

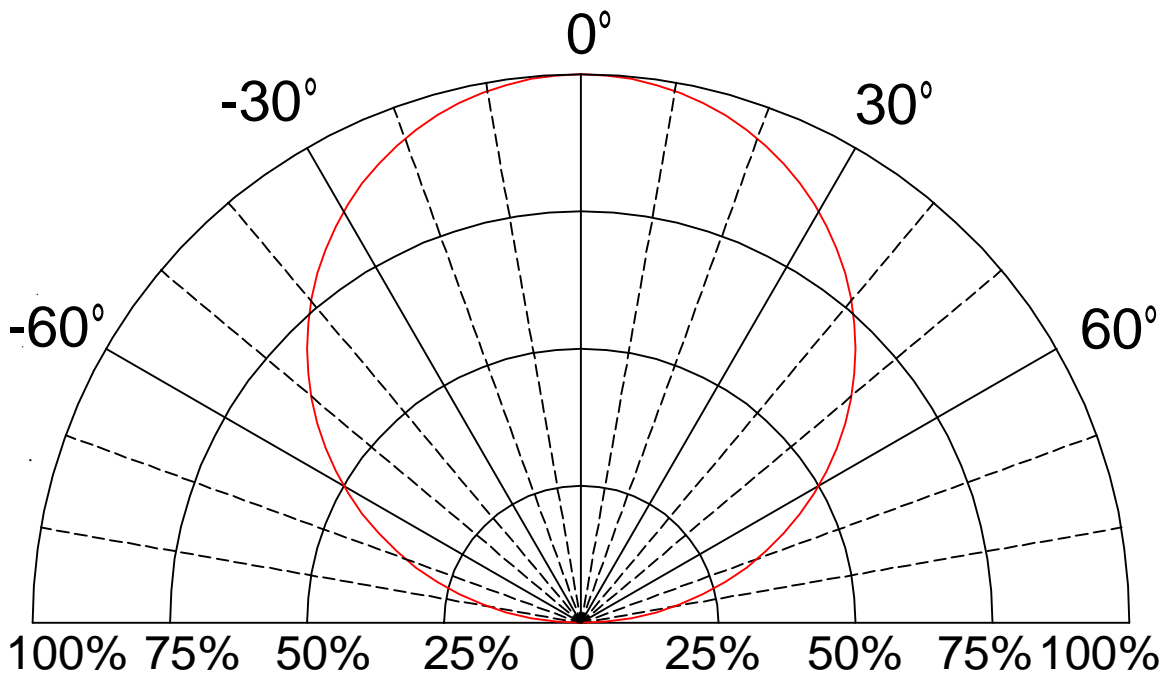

**Absolute Maximum Ratings at Ta=25 °C**

| Parameter | Symbol | Ratings | UNIT |
|-----------------------------------------|------------------|------------|------|
| | | HYS | |
| Forward Current | I _F | 30 | mA |
| Peak Forward Current Duty 1/10@10KHz | I _{FP} | 60 | mA |
| Power Dissipation | PD | 75 | mW |
| Reverse Current @5V | I _r | 10 | μA |
| Electrostatic Discharge(*) | ESD | 2000 | V |
| Operating Temperature | T _{opr} | -40 ~ +85 | °C |
| Storage Temperature | T _{stg} | -40 ~ +100 | °C |

Typical Electrical & Optical Characteristics (Ta=25 °C)

| PART NO | MATERIAL | COLOR | | Dominant wave length λ Dnm | Spectral halfwidth Δ λ nm | Forward voltage @20mA(V) | | Luminous intensity @20mA(mcd) | | Viewing angle 2θ 1/2 (deg) |
|----------|----------|---------|-------------|-------------------------------|------------------------------|-----------------------------|------|----------------------------------|------|----------------------------------|
| | | Emitted | Lens | | | Min. | Max. | Min. | Typ. | |
| LHYS9553 | AlGaInP | Yellow | Water Clear | 587 | 15 | 1.7 | 2.6 | 80 | 200 | 120 |

Note : 1. The forward voltage data did not including ±0.1V testing tolerance.
2. The luminous intensity data did not including ±15% testing tolerance.



Typical Electro-Optical Characteristics Curve

HYS CHIP

Fig.1 Forward current vs. Forward Voltage

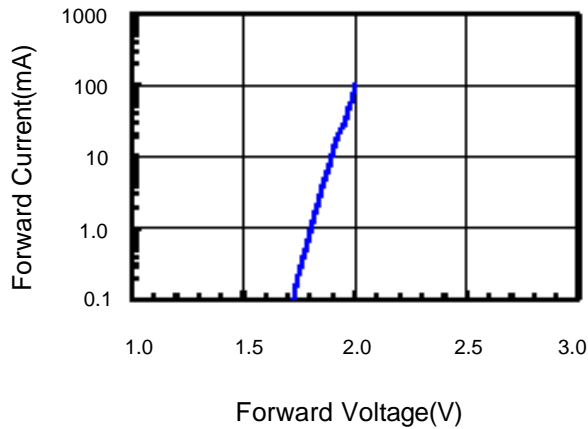

Fig.2 Relative Intensity vs. Forward Current

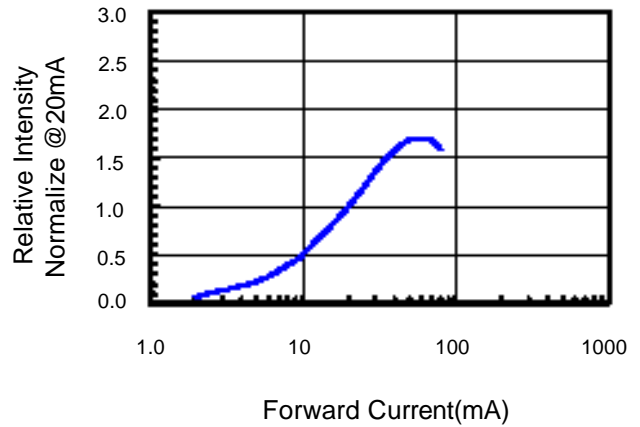

Fig.3 Forward Voltage vs. Temperature

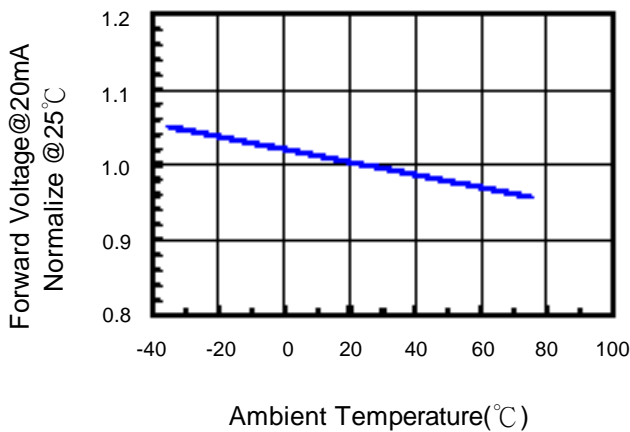

Fig.4 Relative Intensity vs. Temperature

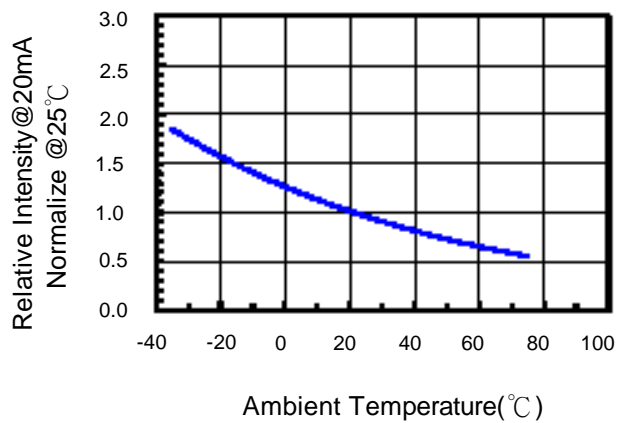
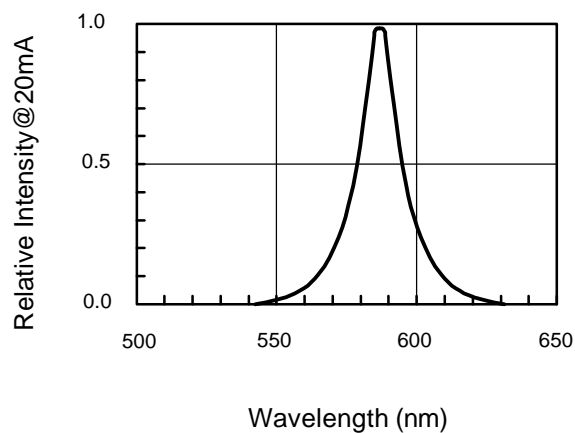

Fig.5 Relative Intensity vs. Wavelength





Recommended Soldering Conditions

1. Hand Solder

Basic spec is $\leq 280^{\circ}\text{C}$ 3 sec one time only.

2. Wave Solder

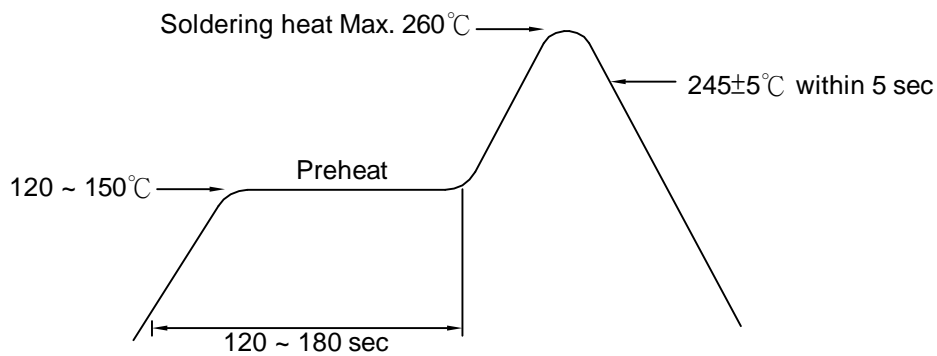

3-1. LEAD Reflow Solder

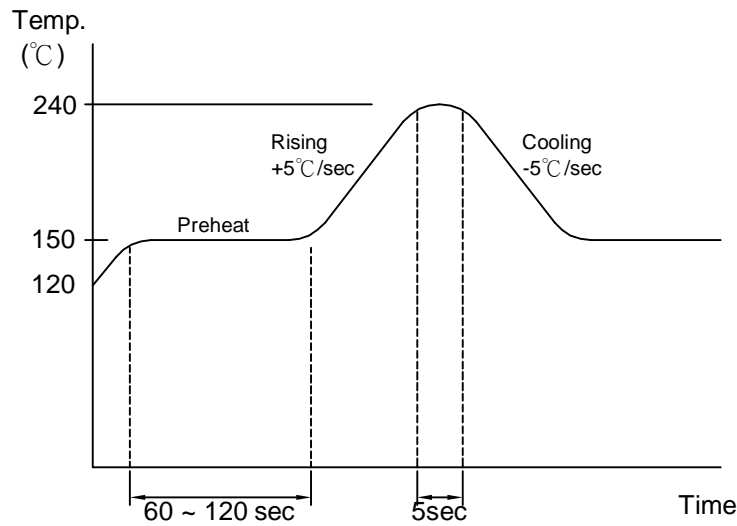

3-2 PB-Free Reflow Solder

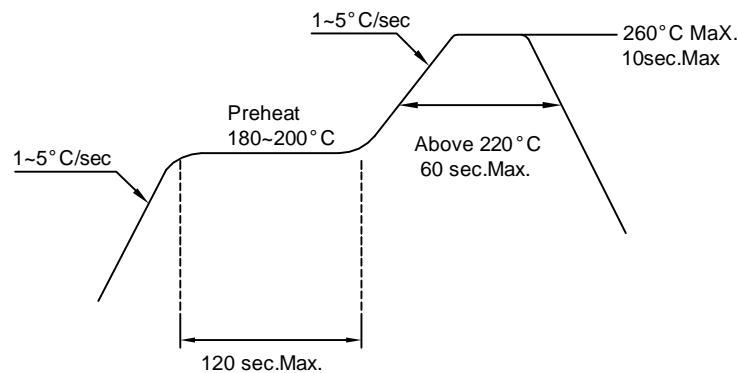

Reflow Soldering should not be done more than two times.

Precautions For Use:
Storage time:

- 1.The operation of Temperatures and RH are : $5^{\circ}\text{C} \sim 35^{\circ}\text{C}$,RH<60%.
- 2.Once the package is opened, the products should be used within a week.
 Otherwise, they should be kept in a damp proof box with descanting agent.
 Considering the tape life, we suggest our customers to use our products within a year(from production date).
- 3.If opened more than one week in an atmosphere $5^{\circ}\text{C} \sim 35^{\circ}\text{C}$,RH<60%, they should be treated at $60^{\circ}\text{C} \pm 5^{\circ}\text{C}$ fo r 15hrs.

Drive Method:

LED is a current operated device, and therefore, requirer some kind of current limiting incorporated into the driver circuit. This current limiting typically takes the form of a current limiting resistor placed in series with the LED.

Consider worst case voltage variations than could occur across the current limiting resistor. The forwr current should not be allowed to change by more than 40% of its desired value.

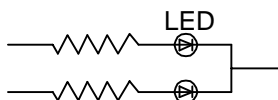
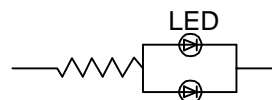
Circuit model A

Circuit model B

(A) Recommended circuit.

(B) The difference of brightness between LED could be found due to the VF-IF characteristics of LED.

Cleaning:

Use alcohol-based cleaning solvents such as isopropyl alcohol to clean the LED.

ESD(Electrostatic Discharge):

Static Electricity or power surge will damage the LED. Use of a conductive wrist band or anti-electrosatic glove is recommended when handing these LED. All devices, equipment and machinery must be properly grounded.



Reliability Test:

| Classification | Test Item | Test Condition | Reference Standard |
|--------------------|---------------------------------------------|------------------------------------------------------------------------------------------------------------------------------------------------------------------------------------------------------------------------------------------------------------------------------------------------|-------------------------------------------------------------------------------------------------------|
| Endurance Test | Operating Life Test | 1.Ta=Under Room Temperature As Per Data Sheet Maximum Rating. 2.If=20mA 3.t=1000 hrs (-24hrs, +72hrs) | MIL-STD-750D: 1026 MIL-STD-883D: 1005 JIS C 7021: B-1 |
| | High Temperature Storage Test | 1.Ta=105 °C±5°C 2.t=1000 hrs (-24hrs, +72hrs) | MIL-STD-883D:1008 JIS C 7021: B-10 |
| | Low Temperature Storage Test | 1.Ta=-40 °C±5°C 2.t=1000 hrs (-24hrs, +72hrs) | JIS C 7021: B-12 |
| | High Temperature High Humidity Storage Test | 1.Ta=65 °C±5°C 2.RH=90%~95% 3.t=1000hrs ±2hrs | MIL-STD-202F:103B JIS C 7021: B-11 |
| Environmental Test | Thermal Shock Test | 1.Ta=105 °C ±5°C & -40 °C ±5°C (10min) (10min) 2.total 10 cycles | MIL-STD-202F: 107D MIL-STD-750D: 1051 MIL-STD-883D: 1011 |
| | Solderability Test | 1.T.Sol=235 °C±5°C 2.Immersion time 2 ±0.5sec 3.Coverage ≥95% of the dipped surface | MIL-STD-202F: 208D MIL-STD-750D: 2026 MIL-STD-883D: 2003 IEC 68 Part 2-20 JIS C 7021: A-2 |
| | Temperature Cycling | 1.105 °C ~ 25 °C ~ -55 °C ~ 25 °C 30mins 5mins 30mins 5mins 2.10 Cyeles | MIL-STD-202F: 107D MIL-STD-750D: 1051 MIL-STD-883D: 1010 JIS C 7021: A-4 |
| | IR Reflow | Ramp-up rate(183 °C to Peak) +3 °C second max Temp. maintain at 125(±25) °C 120 seconds max Temp. maintain above 183 °C 60-150 seconds Peak temperature range 235 °C +5/-0 °C Time within 5 °C of actual Peak Temperature(tp) 10-30 seconds Ramp-down rate +6 °C/second max | MIL-STD-750D:2031.2 J-STD-020 |