

# 1SS314

## SILICON EPITAXIAL PLANAR DIODE

### Applications

- VHF Tuner Band Switch

### PINNING

PIN	DESCRIPTION
1	Cathode
2	Anode

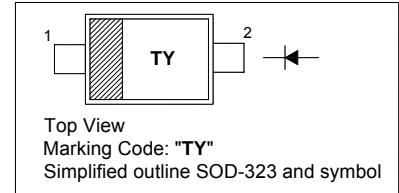

### Absolute Maximum Ratings ( $T_a = 25\text{ }^\circ\text{C}$ )

Parameter	Symbol	Value	Unit
Reverse Voltage	$V_R$	30	V
Forward Current	$I_F$	100	mA
Junction Temperature	$T_J$	125	$^\circ\text{C}$
Storage Temperature Range	$T_{stg}$	- 55 to + 125	$^\circ\text{C}$

### Characteristics at $T_a = 25\text{ }^\circ\text{C}$

Parameter	Symbol	Min.	Max.	Unit
Forward Voltage at $I_F = 2\text{ mA}$	$V_F$	-	0.85	V
Reverse Current at $V_R = 15\text{ V}$	$I_R$	-	0.1	$\mu\text{A}$
Reverse Voltage at $I_R = 1\text{ }\mu\text{A}$	$V_R$	30	-	V
Total Capacitance at $V_R = 6\text{ V}$ , $f = 1\text{ MHz}$	$C_T$	-	1.2	pF
Series Resistance at $I_F = 2\text{ mA}$ , $f = 100\text{ MHz}$	$r_s$	-	0.9	$\Omega$

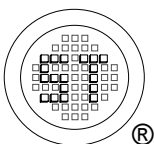

**SEMTECH ELECTRONICS LTD.**

(Subsidiary of Sino-Tech International Holdings Limited, a company  
listed on the Hong Kong Stock Exchange, Stock Code: 724)



ISO/TS 16949 : 2002  
Certificate No. 05103



ISO 14001:2004  
Certificate No. 7116



ISO 9001:2000  
Certificate No. 0506098

Dated : 01/09/2005

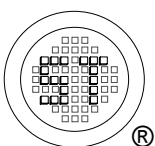
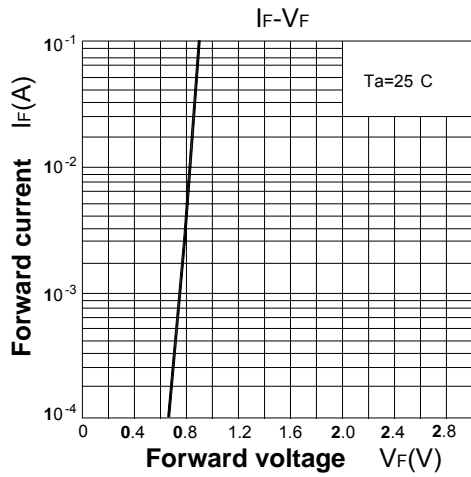
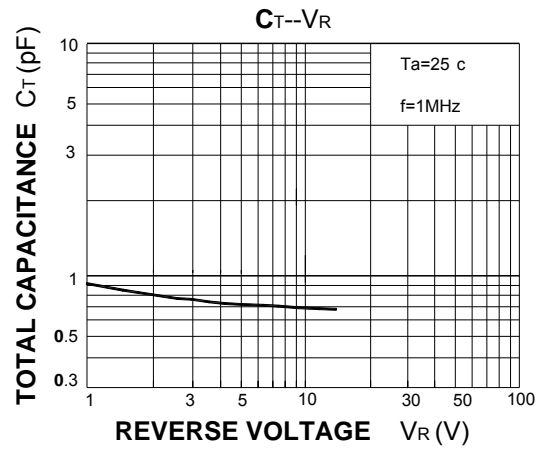
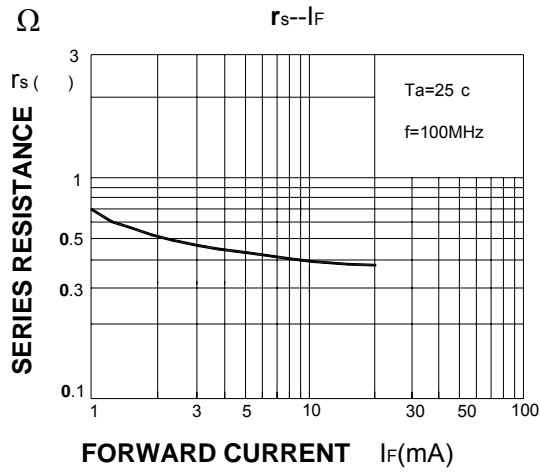

**SEMTECH ELECTRONICS LTD.**  
 (Subsidiary of Sino-Tech International Holdings Limited, a company listed on the Hong Kong Stock Exchange, Stock Code: 724)



## PACKAGE OUTLINE

Plastic surface mounted package; 2 leads

SOD-323

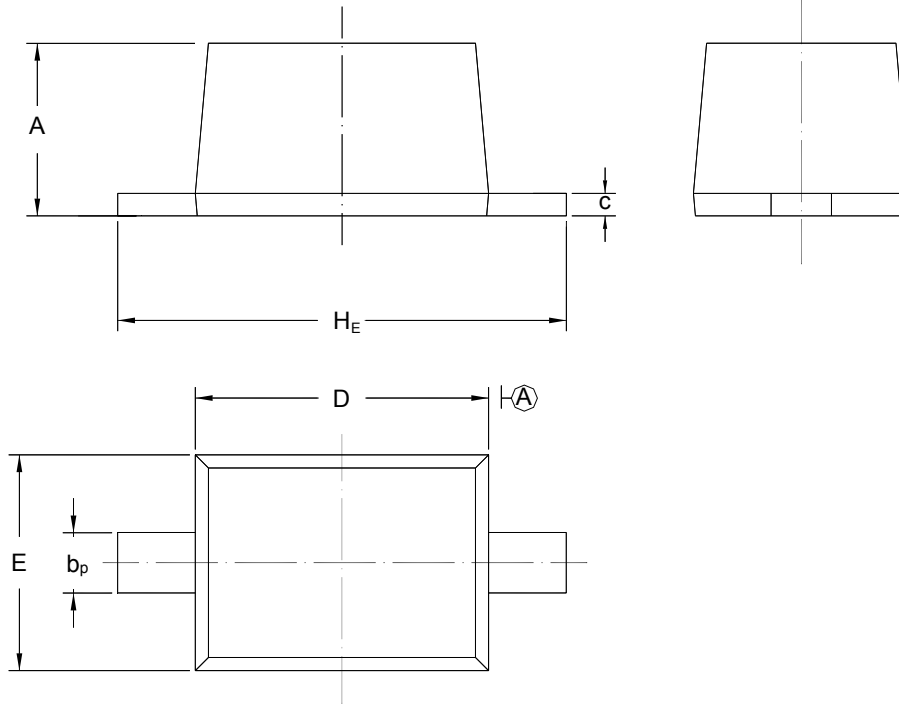

UNIT	A	$b_p$	C	D	E	$H_E$
mm	1.10 0.80	0.40 0.25	0.15 0.00	1.80 1.60	1.35 1.15	2.80 2.30

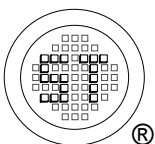

**SEMTECH ELECTRONICS LTD.**  
 (Subsidiary of Sino-Tech International Holdings Limited, a company  
 listed on the Hong Kong Stock Exchange, Stock Code: 724)



Dated : 01/09/2005