

Triple-Balanced Mixer

Rev. V3

Features

- LO 2 TO 24 GHz
- RF 2 TO 24 GHz
- IF 0.1 TO 5 GHz
- LO DRIVE: +10 dBm (NOMINAL)
- HIGH COMPRESSION POINT
- VERY WIDE BANDWIDTH

Description

MY52 is a triple balanced mixer, designed for use in military, commercial and test equipment applications. The design utilizes Schottky ring quad diodes and broadband soft dielectric baluns to attain excellent performance. The use of high temperature solder assembly processes used internally makes it ideal for use in manual, semi-automated assembly. Environmental screening available to MIL-STD-883, MIL-STD-202 or MIL-DTL-28837, consult factory.

Ordering Information

Part Number	Package
MY52	Versapac
MY52C	SMA Connectorized

Product Image



Electrical Specifications: $Z_0 = 50\Omega$ $Lo = +10$ dBm (Downconverter Application only)

Parameter	Test Conditions	Units	Typical	Guaranteed	
				+25°C	-54° to +85°C
SSB Conversion Loss (max) & SSB Noise Figure (max)	$f_R = 8$ to 18 GHz, $f_L = 8$ to 18 GHz, $f_I = 0.1$ to 4 GHz	dB	7.5	9.5	10.0
	$f_R = 2$ to 8 GHz, $f_L = 2$ to 8 GHz, $f_I = 1$ to 4 GHz	dB	8.0	10.0	10.5
	$f_R = 2$ to 18 GHz, $f_L = 2$ to 18 GHz, $f_I = 0.1$ to 5 GHz	dB	8.5	10.5	11.0
	$f_R = 18$ to 24 GHz, $f_L = 13$ to 24 GHz, $f_I = 0.1$ to 5 GHz	dB	9.5	12.5	13.0
Isolation, L to R (min)	$f_L = 2$ to 24 GHz	dB	18	15	13
	$f_L = 4$ to 19 GHz	dB	25	20	18
Isolation, L to I (min)	$f_L = 2$ to 20 GHz	dB	30	22	20
	$f_L = 20$ to 24 GHz	dB	20	15	13
1 dB Conversion Comp.	$f_L = +10$ dBm	dBm	+5		
Input IP3	$f_{R1} = 3.75$ GHz at -6 dBm, $f_{R2} = 3.76$ GHz at -6 dBm, $f_L = 4$ GHz at +10 dBm	dBm	+16		
	$f_{R1} = 13$ GHz at -6 dBm, $f_{R2} = 13.01$ GHz at -6 dBm, $f_L = 11$ GHz at +10 dBm	dBm	+16		
	$f_{R1} = 20$ GHz at -6 dBm, $f_{R2} = 20.01$ GHz at -6 dBm, $f_L = 24$ GHz at +10 dBm	dBm	+13		

1

ADVANCED: Data Sheets contain information regarding a product M/A-COM Technology Solutions is considering for development. Performance is based on target specifications, simulated results, and/or prototype measurements. Commitment to develop is not guaranteed.

PRELIMINARY: Data Sheets contain information regarding a product M/A-COM Technology Solutions has under development. Performance is based on engineering tests. Specifications are typical. Mechanical outline has been fixed. Engineering samples and/or test data may be available. Commitment to produce in volume is not guaranteed.

• **North America** Tel: 800.366.2266 • **Europe** Tel: +353.21.244.6400
 • **India** Tel: +91.80.4155721 • **China** Tel: +86.21.2407.1588
 Visit www.macomtech.com for additional data sheets and product information.

M/A-COM Technology Solutions Inc. and its affiliates reserve the right to make changes to the product(s) or information contained herein without notice.

Typical Performance Curves

Conversion Loss vs. Frequency

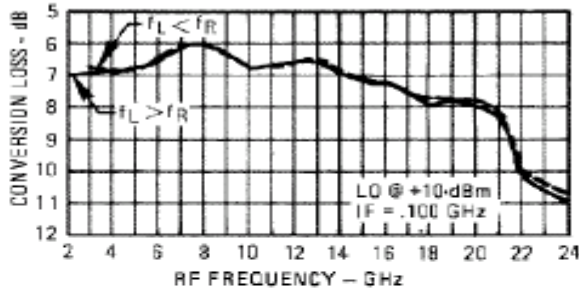

Drive Level

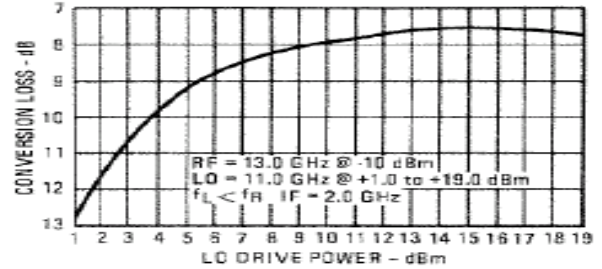

Conversion Loss vs. Frequency

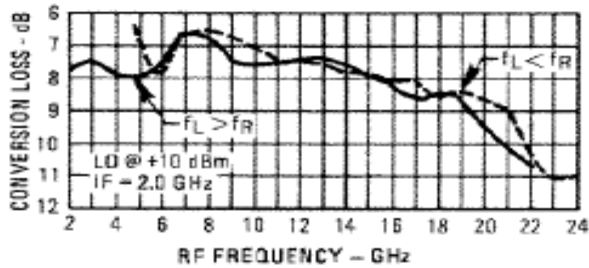

Isolation vs. Frequency

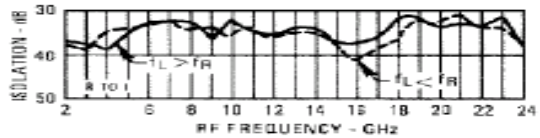
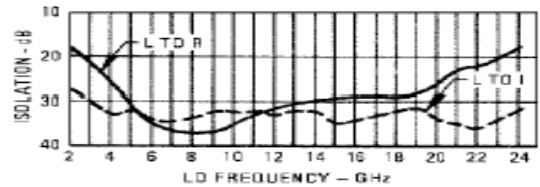

L-Port VSWR

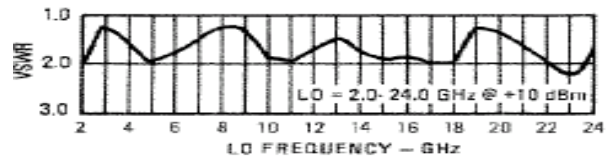

Conversion Loss vs. Frequency

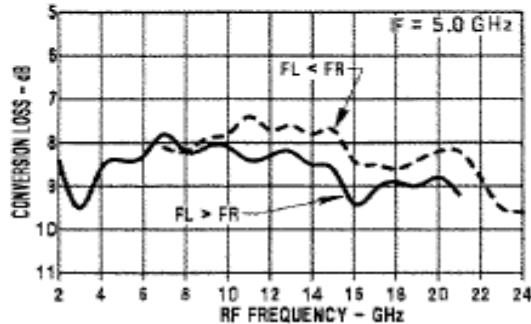

I-Port VSWR

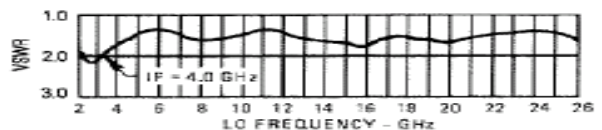
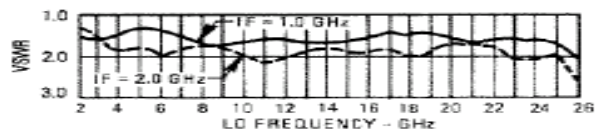
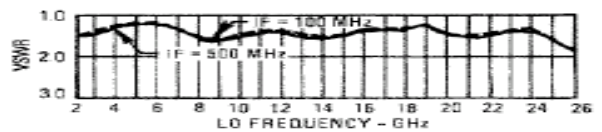

Triple-Balanced Mixer

Rev. V3

Absolute Maximum Ratings

Parameter	Absolute Maximum
Operating Temperature	-54°C to +100°C
Storage Temperature	-65°C to +100°C
Peak Input Power	+26 dBm max @ +25°C +22 dBm max @ +100°C
Peak Input Current	mA DC

Outline Drawing: Versapac *

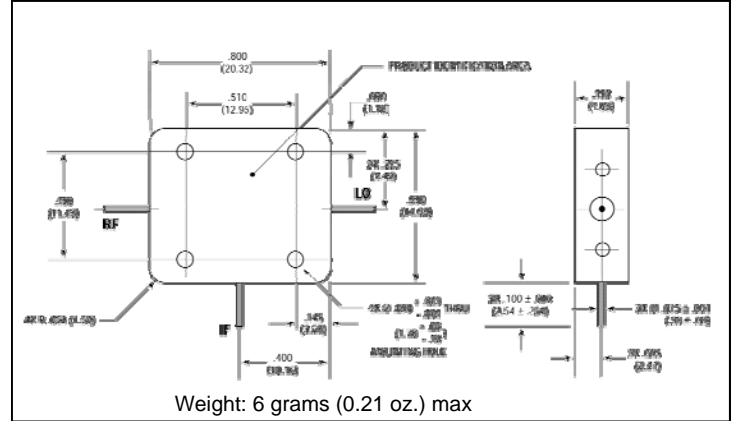

Outline Drawing: SMA Connectorized *

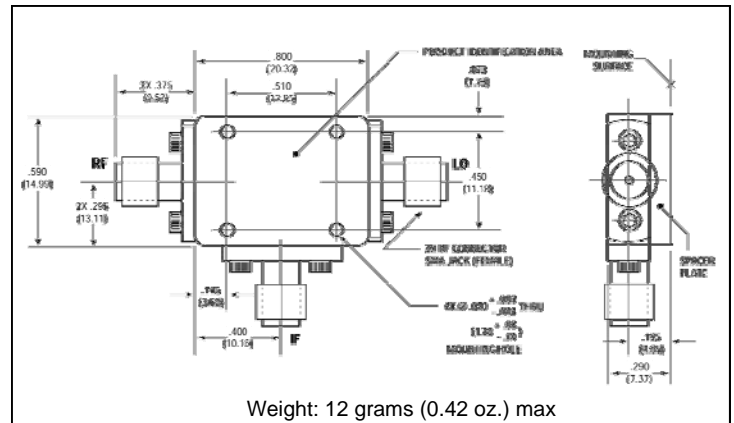

R-Port VSWR

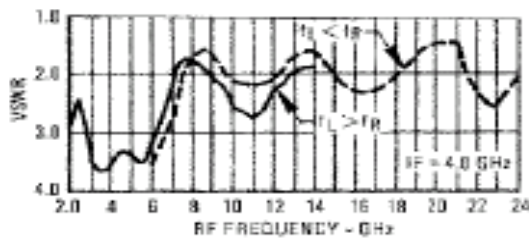
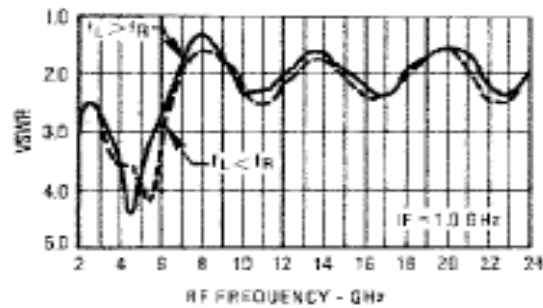
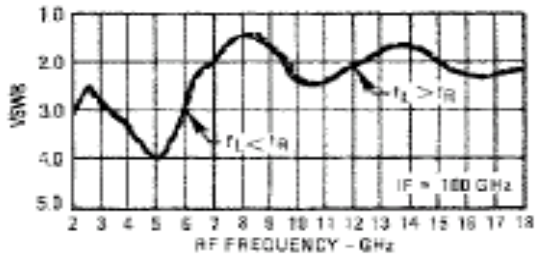

* Dimensions are inches (millimeters) ±0.015 (0.38) unless otherwise specified.