

NTMFS4120N

Power MOSFET

30 V, 31 A, Single N-Channel,
SO-8 Flat Lead

Features

- Low $R_{DS(on)}$
- Optimized Gate Charge
- Low Inductance SO-8 Package
- These are Pb-Free Devices

Applications

- Notebooks, Graphics Cards
- DC-DC Converters
- Synchronous Rectification

MAXIMUM RATINGS ($T_J = 25^\circ\text{C}$ unless otherwise noted)

Parameter	Symbol	Value	Unit			
Drain-to-Source Voltage	V_{DSS}	30	V			
Gate-to-Source Voltage	V_{GS}	± 20	V			
Continuous Drain Current (Note 1)	Steady State	$T_A = 25^\circ\text{C}$	I_D	18	A	
		$T_A = 85^\circ\text{C}$				13
		$t \leq 10 \text{ s}$				$T_A = 25^\circ\text{C}$
Power Dissipation (Note 1)	Steady State	$T_A = 25^\circ\text{C}$	P_D	2.2	W	
				$t \leq 10 \text{ s}$		6.9
Continuous Drain Current (Note 2)	Steady State	$T_A = 25^\circ\text{C}$	I_D	11	A	
		$T_A = 85^\circ\text{C}$		8.0		
		$T_A = 25^\circ\text{C}$		P_D		0.9
Power Dissipation (Note 2)						
Pulsed Drain Current	$t_p = 10 \mu\text{s}$	I_{DM}	94	A		
Operating Junction and Storage Temperature	T_J, T_{stg}	-55 to 150	$^\circ\text{C}$			
Source Current (Body Diode)	I_S	7.0	A			
Single Pulse Drain-to-Source Avalanche Energy ($V_{DD} = 30 \text{ V}$, $V_{GS} = 10 \text{ V}$, $I_{PK} = 30 \text{ A}$, $L = 1 \text{ mH}$, $R_G = 25 \Omega$)	E_{AS}	450	mJ			
Lead Temperature for Soldering Purposes (1/8" from case for 10 s)	T_L	260	$^\circ\text{C}$			

THERMAL RESISTANCE MAXIMUM RATINGS

Parameter	Symbol	Value	Unit
Junction-to-Case - Steady State	$R_{\theta JC}$	1.7	$^\circ\text{C/W}$
Junction-to-Ambient - Steady State (Note 1)	$R_{\theta JA}$	55.8	
Junction-to-Ambient - $t \leq 10 \text{ s}$ (Note 1)	$R_{\theta JA}$	18	
Junction-to-Ambient - Steady State (Note 2)	$R_{\theta JA}$	139.1	

Stresses exceeding Maximum Ratings may damage the device. Maximum Ratings are stress ratings only. Functional operation above the Recommended Operating Conditions is not implied. Extended exposure to stresses above the Recommended Operating Conditions may affect device reliability.

1. Surface mounted on FR4 board using 1 in sq pad size (Cu area = 1.127 in sq [1 oz] including traces).
2. Surface mounted on FR4 board using the minimum recommended pad size (Cu area = 1.0 in sq).



ON Semiconductor®

<http://onsemi.com>

$V_{(BR)DSS}$	$R_{DS(on)}$ Typ	I_D Max (Note 1)
30 V	3.5 m Ω @ 10 V	31 A
	4.2 m Ω @ 4.5 V	

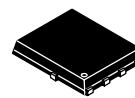
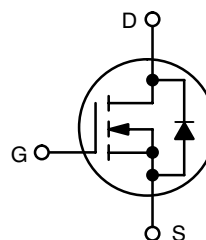

SO-8 FLAT LEAD
CASE 488AA
STYLE 1

MARKING DIAGRAM

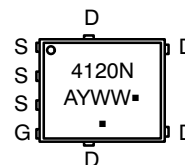

4120N = Specific Device Code
A = Assembly Location
Y = Year
WW = Work Week
▪ = Pb-Free Package

(Note: Microdot may be in either location)

ORDERING INFORMATION

Device	Package	Shipping†
NTMFS4120NT1G	SO-8 FL (Pb-Free)	1500 Tape & Reel
NTMFS4120NT3G	SO-8 FL (Pb-Free)	5000 Tape & Reel

†For information on tape and reel specifications, including part orientation and tape sizes, please refer to our Tape and Reel Packaging Specification Brochure, BRD8011/D.

NTMFS4120N

ELECTRICAL CHARACTERISTICS ($T_J = 25^\circ\text{C}$ unless otherwise noted)

Characteristic	Symbol	Test Condition	Min	Typ	Max	Unit
OFF CHARACTERISTICS						
Drain-to-Source Breakdown Voltage	$V_{(BR)DSS}$	$V_{GS} = 0\text{ V}, I_D = 250\ \mu\text{A}$	30			V
Drain-to-Source Breakdown Voltage Temperature Coefficient	$V_{(BR)DSS}/T_J$			21		mV/°C
Zero Gate Voltage Drain Current	I_{DSS}	$V_{GS} = 0\text{ V}, V_{DS} = 24\text{ V}$	$T_J = 25^\circ\text{C}$		1.0	μA
			$T_J = 125^\circ\text{C}$		10	
Gate-to-Source Leakage Current	I_{GSS}	$V_{DS} = 0\text{ V}, V_{GS} = 20\text{ V}$			100	nA

ON CHARACTERISTICS (Note 3)

Gate Threshold Voltage	$V_{GS(TH)}$	$V_{GS} = V_{DS}, I_D = 250\ \mu\text{A}$	1.0		2.5	V
Negative Threshold Temperature Coefficient	$V_{GS(TH)}/T_J$			7.4		mV/°C
Drain-to-Source On Resistance	$R_{DS(on)}$	$V_{GS} = 10\text{ V}, I_D = 26\text{ A}$		3.5	4.5	m Ω
		$V_{GS} = 4.5\text{ V}, I_D = 24\text{ A}$		4.2	5.5	
Forward Transconductance	g_{FS}	$V_{DS} = 15\text{ V}, I_D = 26\text{ A}$		35		S

CHARGES, CAPACITANCES AND GATE RESISTANCE

Input Capacitance	C_{ISS}	$V_{GS} = 0\text{ V}, f = 1.0\text{ MHz}, V_{DS} = 24\text{ V}$		3600		pF
Output Capacitance	C_{OSS}			640		
Reverse Transfer Capacitance	C_{RSS}			380		
Total Gate Charge	$Q_{G(TOT)}$	$V_{GS} = 4.5\text{ V}, V_{DS} = 15\text{ V}, I_D = 24\text{ A}$		33	50	nC
Threshold Gate Charge	$Q_{G(TH)}$			4.4		
Gate-to-Source Charge	Q_{GS}			13		
Gate-to-Drain Charge	Q_{GD}			14		
Gate Resistance	R_G			1.0		

SWITCHING CHARACTERISTICS (Note 4)

Turn-On Delay Time	$t_{d(ON)}$	$V_{GS} = 4.5\text{ V}, V_{DS} = 15\text{ V}, I_D = 1.0\text{ A}, R_G = 3.0\ \Omega$		24		ns
Rise Time	t_r			32		
Turn-Off Delay Time	$t_{d(OFF)}$			27		
Fall Time	t_f			31		

DRAIN-SOURCE DIODE CHARACTERISTICS

Forward Diode Voltage	V_{SD}	$V_{GS} = 0\text{ V}, I_S = 6.0\text{ A}$	$T_J = 25^\circ\text{C}$		0.74	1.0	V
			$T_J = 125^\circ\text{C}$		0.6		
Reverse Recovery Time	t_{RR}	$V_{GS} = 0\text{ V}, dI_S/dt = 100\text{ A}/\mu\text{s}, I_S = 6.0\text{ A}$		36		ns	
Charge Time	t_a			18			
Discharge Time	t_b			18			
Reverse Recovery Charge	Q_{RR}			34			nC

3. Pulse Test: Pulse Width $\leq 300\ \mu\text{s}$, Duty Cycle $\leq 2\%$.

4. Switching characteristics are independent of operating junction temperatures.

TYPICAL PERFORMANCE CURVES

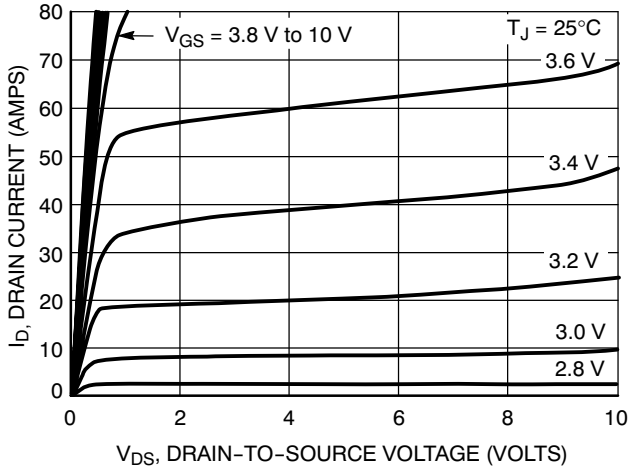

Figure 1. On-Region Characteristics

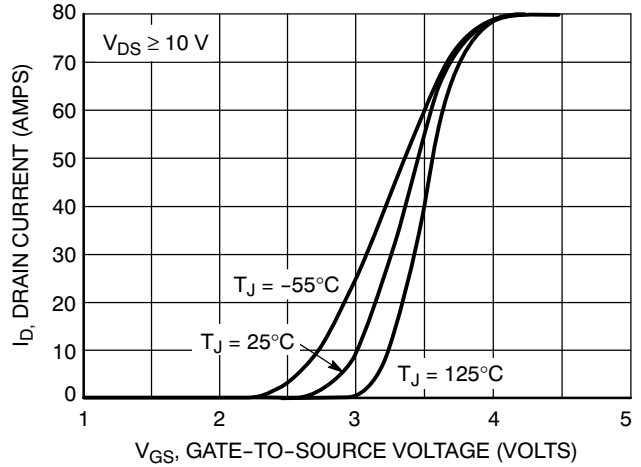

Figure 2. Transfer Characteristics

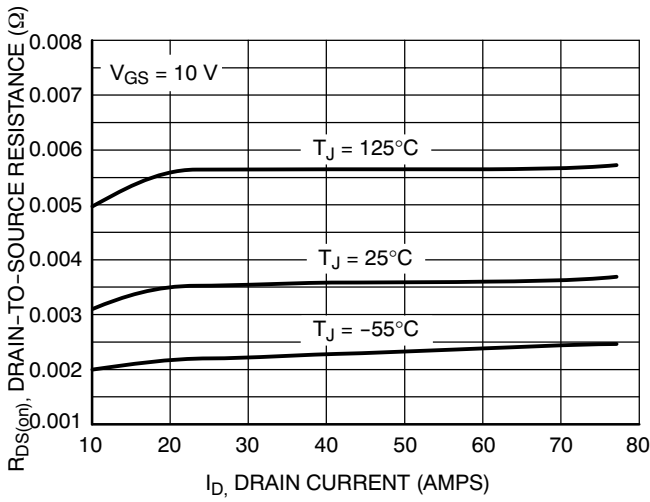

Figure 3. On-Resistance vs. Drain Current and Temperature

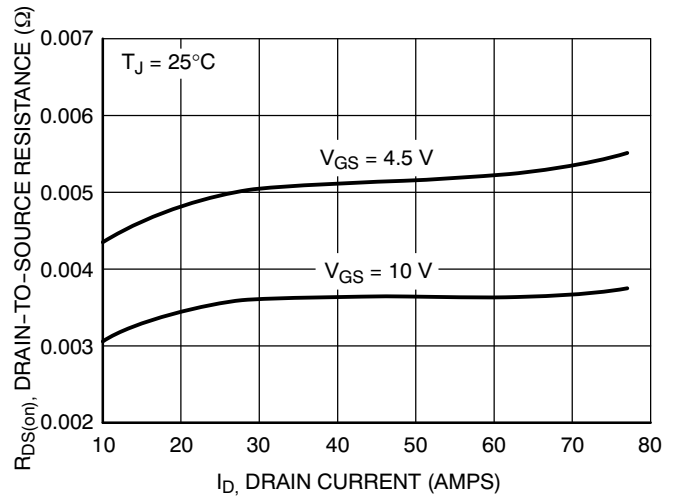

Figure 4. On-Resistance vs. Drain Current and Gate Voltage

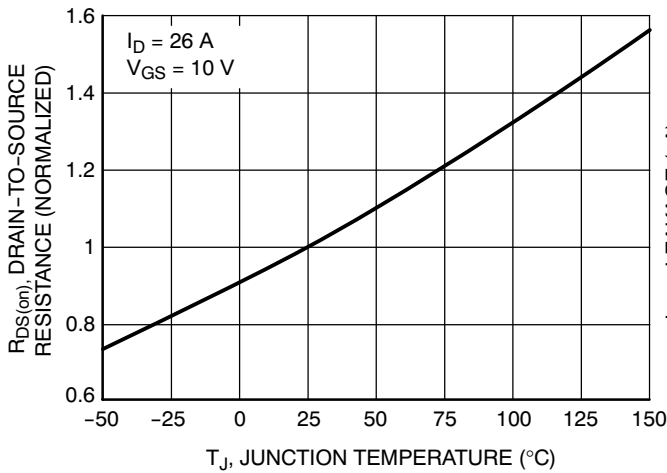

Figure 5. On-Resistance Variation with Temperature

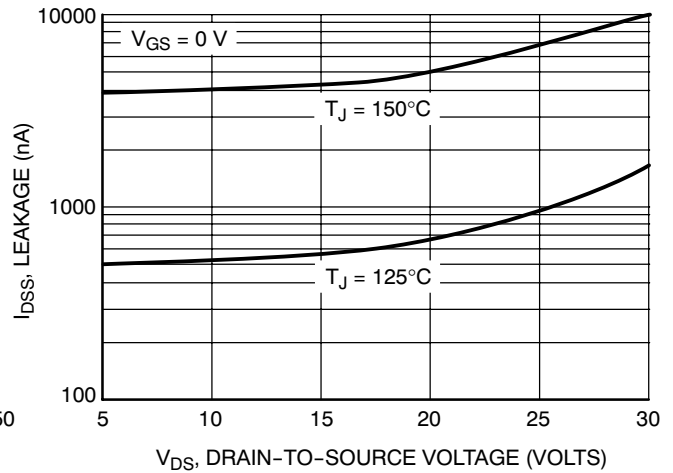

Figure 6. Drain-to-Source Leakage Current vs. Voltage

NTMFS4120N

TYPICAL PERFORMANCE CURVES

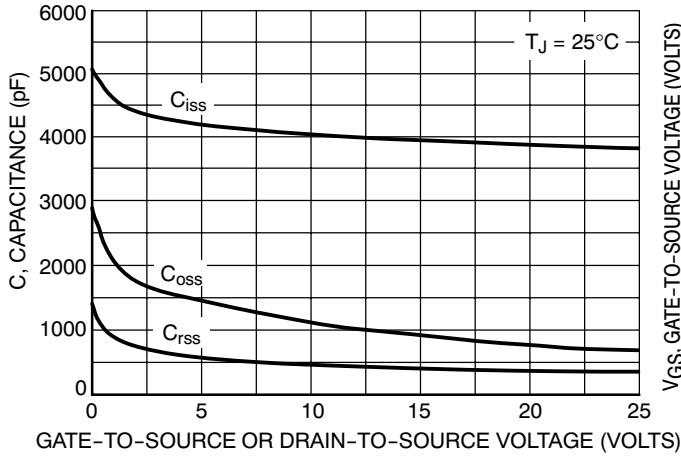

Figure 7. Capacitance Variation

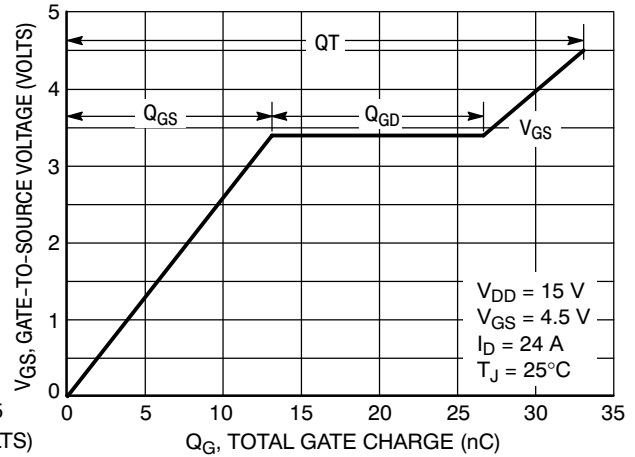

Figure 8. Gate-To-Source and Drain-To-Source Voltage vs. Total Charge

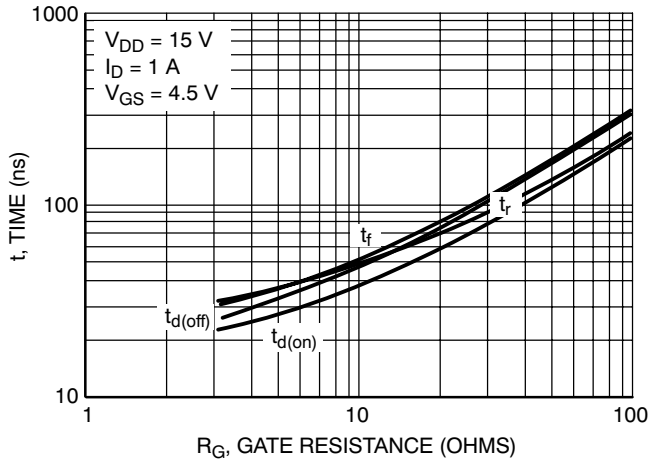

Figure 9. Resistive Switching Time Variation vs. Gate Resistance

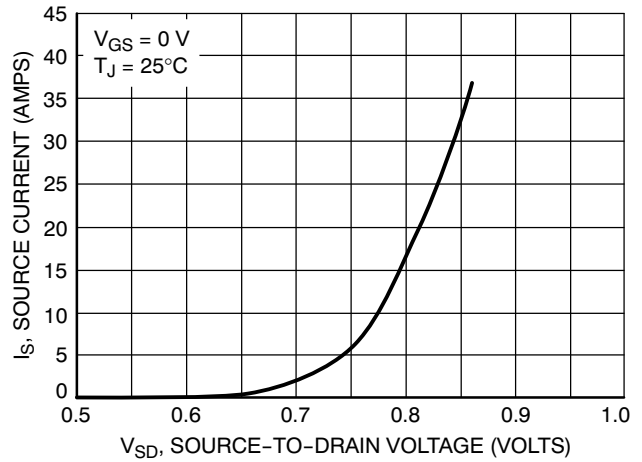

Figure 10. Diode Forward Voltage vs. Current

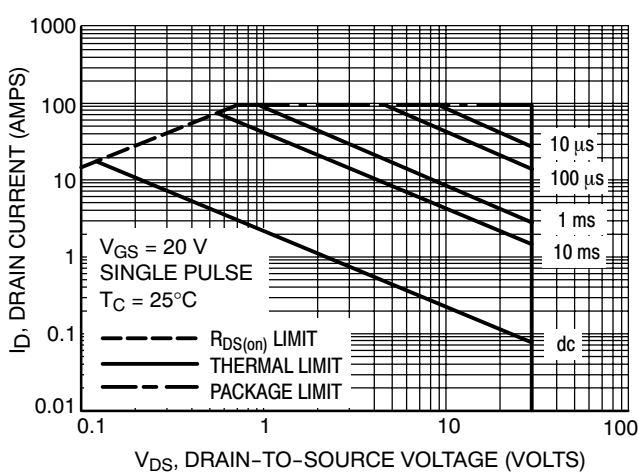

Figure 11. Maximum Rated Forward Biased Safe Operating Area

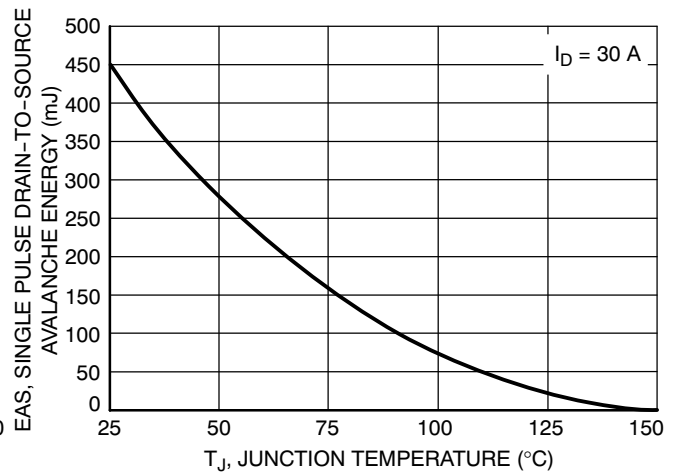

Figure 12. Maximum Avalanche Energy vs Starting Junction Temperature

NTMFS4120N

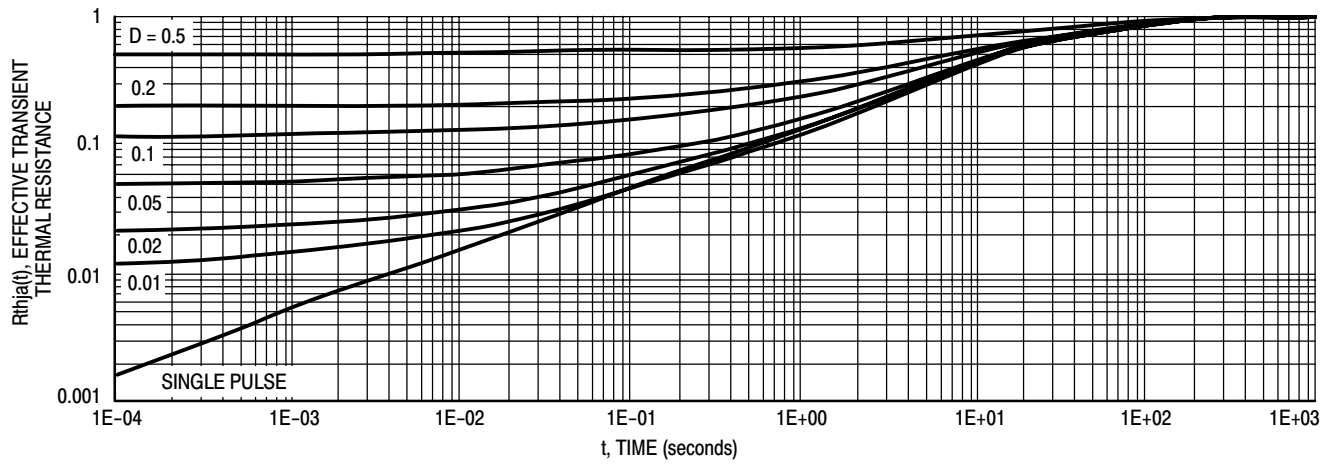
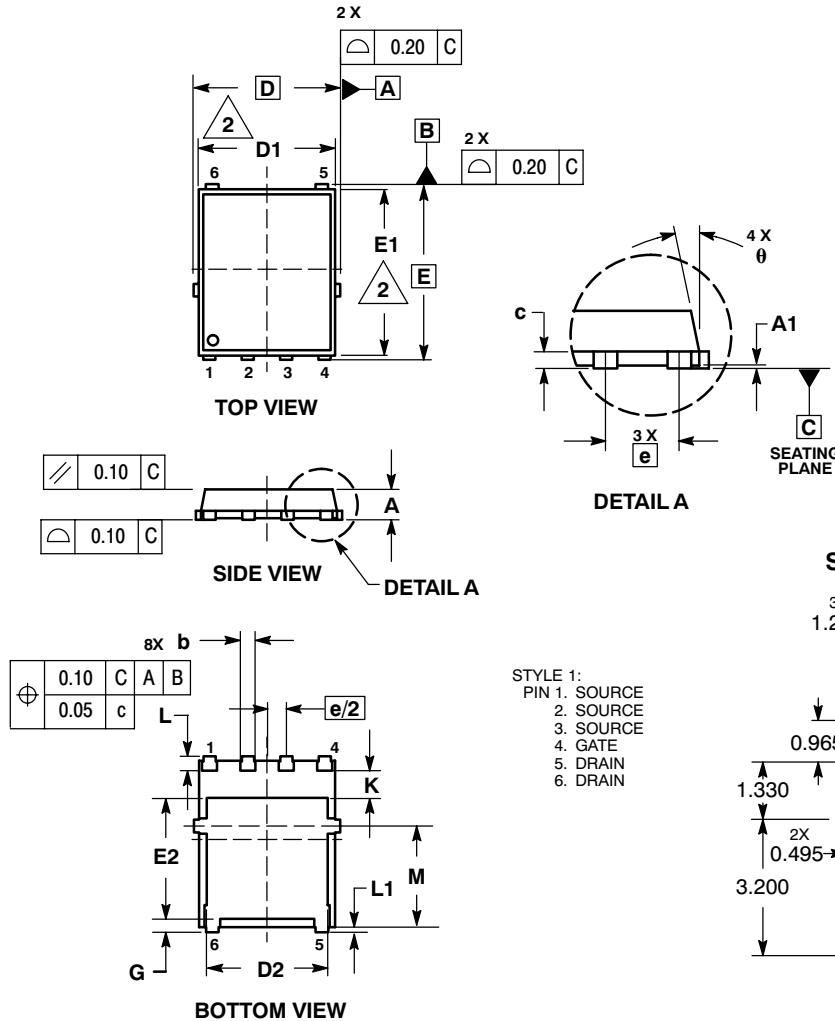

Figure 13. Thermal Response

NTMFS4120N

PACKAGE DIMENSIONS

DFN6 5x6, 1.27P (SO8 FL)
CASE 488AA-01
ISSUE C



- NOTES:
1. DIMENSIONING AND TOLERANCING PER ASME Y14.5M, 1994.
 2. CONTROLLING DIMENSION: MILLIMETER.
 3. DIMENSION D1 AND E1 DO NOT INCLUDE MOLD FLASH PROTRUSIONS OR GATE BURRS.

DIM	MILLIMETERS		
	MIN	NOM	MAX
A	0.90	1.00	1.10
A1	0.00	---	0.05
b	0.33	0.41	0.51
c	0.23	0.28	0.33
D	5.15 BSC		
D1	4.50	4.90	5.10
D2	3.50	---	4.22
E	6.15 BSC		
E1	5.50	5.80	6.10
E2	3.45	---	4.30
e	1.27 BSC		
G	0.51	0.61	0.71
K	0.51	---	---
L	0.51	0.61	0.71
L1	0.05	0.17	0.20
M	3.00	3.40	3.80
theta	0°	---	12°

SOLDERING FOOTPRINT*

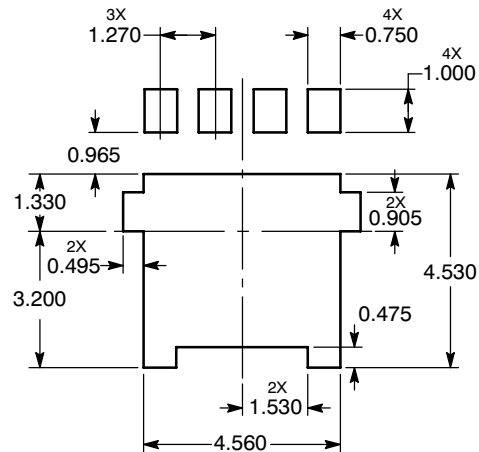

- STYLE 1:
PIN 1. SOURCE
2. SOURCE
3. SOURCE
4. GATE
5. DRAIN
6. DRAIN

*For additional information on our Pb-Free strategy and soldering details, please download the ON Semiconductor Soldering and Mounting Techniques Reference Manual, SOLDERRM/D.

ON Semiconductor and are registered trademarks of Semiconductor Components Industries, LLC (SCILLC). SCILLC reserves the right to make changes without further notice to any products herein. SCILLC makes no warranty, representation or guarantee regarding the suitability of its products for any particular purpose, nor does SCILLC assume any liability arising out of the application or use of any product or circuit, and specifically disclaims any and all liability, including without limitation special, consequential or incidental damages. "Typical" parameters which may be provided in SCILLC data sheets and/or specifications can and do vary in different applications and actual performance may vary over time. All operating parameters, including "Typicals" must be validated for each customer application by customer's technical experts. SCILLC does not convey any license under its patent rights nor the rights of others. SCILLC products are not designed, intended, or authorized for use as components in systems intended for surgical implant into the body, or other applications intended to support or sustain life, or for any other application in which the failure of the SCILLC product could create a situation where personal injury or death may occur. Should Buyer purchase or use SCILLC products for any such unintended or unauthorized application, Buyer shall indemnify and hold SCILLC and its officers, employees, subsidiaries, affiliates, and distributors harmless against all claims, costs, damages, and expenses, and reasonable attorney fees arising out of, directly or indirectly, any claim of personal injury or death associated with such unintended or unauthorized use, even if such claim alleges that SCILLC was negligent regarding the design or manufacture of the part. SCILLC is an Equal Opportunity/Affirmative Action Employer. This literature is subject to all applicable copyright laws and is not for resale in any manner.

PUBLICATION ORDERING INFORMATION

LITERATURE FULFILLMENT:
Literature Distribution Center for ON Semiconductor
RD, Box 5163, Denver, Colorado 80217 USA
Phone: 303-675-2175 or 800-344-3860 Toll Free USA/Canada
Fax: 303-675-2176 or 800-344-3867 Toll Free USA/Canada
Email: orderlit@onsemi.com

N. American Technical Support: 800-282-9855 Toll Free
USA/Canada
Europe, Middle East and Africa Technical Support:
Phone: 421 33 790 2910
Japan Customer Focus Center
Phone: 81-3-5773-3850

ON Semiconductor Website: www.onsemi.com
Order Literature: <http://www.onsemi.com/orderlit>

For additional information, please contact your local Sales Representative