

PLEASE CHECK WWW.MOLEX.COM FOR LATEST PART INFORMATION

Part Number: [0190710240](#)
Status: **Active**
Description: InsulKrimp™ Ring Tongue Terminal for 4 AWG Wire

Documents:

[Drawing \(PDF\)](#) [RoHS Certificate of Compliance \(PDF\)](#)
[Product Specification PS-19902-009 \(PDF\)](#)

General

Product Family	Ring and Spade Terminals
Series	19071
Crimp Quality Equipment	Yes
Mil-Spec	N/A
Product Name	InsulKrimp™
Type	Ring

Physical

Barrel Type	Closed
Color - Resin	Natural
Insulation	PVC
Material - Plating Mating	Tin
Packaging Type	Bag
Stud Size	3/8" (M9)
Wire Insulation Diameter	13.10mm (.515") max.
Wire Size AWG	4

Material Info

Old Part Number	F-666-38X
-----------------	-----------

Reference - Drawing Numbers

Product Specification	PS-19902-009
Sales Drawing	SD-19071-004

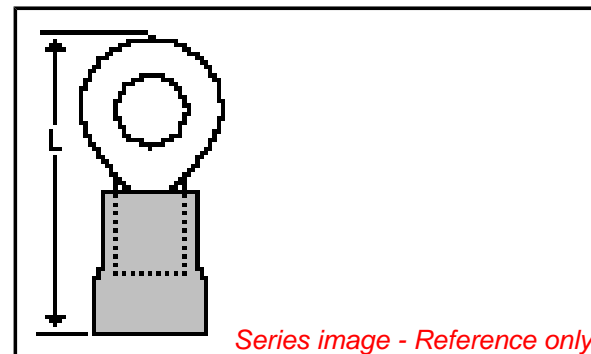

EU RoHS

**ELV and RoHS
Compliant**
REACH SVHC
 Not Reviewed
**Halogen-Free
Status**
Not Reviewed

China RoHS



**Need more information on product
environmental compliance?**

Email productcompliance@molex.com
 For a multiple part number RoHS Certificate of
 Compliance, [click here](#)

Please visit the [Contact Us](#) section for any
 non-product compliance questions.

Search Parts in this Series

[19071Series](#)

Application Tooling | [FAQ](#)

*Tooling specifications and manuals are
 found by selecting the products below.
 Crimp Height Specifications are then
 contained in the Application Tooling
 Specification document.*

Global

Description	Product #
Manual Putt Pump Hydraulic System, Die set required	0192860117
Die Set (large) for the HHLS Hydraulic Crimper	0192890007
Hand Crimp Tool	0640013900
Putt Pump Dieless Head System	0192860065

INSULKRIMP X

MATERIAL: Copper
 PLATING: Electro-Tin (.0003 Min.)
 INSULATION: PVC Color Coded Yellow
 STUD SIZES: ("D" ±.005)

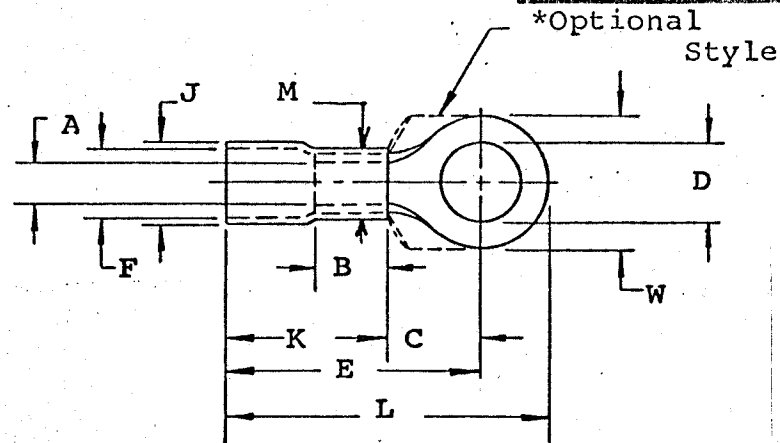

"M" = .545 Maximum

ASSEMBLY IS ROHS COMPLIANT.

Part Number	"W"	"C" Min.	"E" Max.	"K" Max.	"L" Max.	"A" Min. Avg.	"F" (MWID)	THICKNESS REF	"J" Max.	"B" Min.	Available Stud Size
F-666-X	.678 .652	.520	1.534	.968	1.846	.275	.515	.067	.615	.425	10, 14, 56, 38, 76, 12
F-667-X	.485 .465	.520	1.534	.968	1.756	.275	.515	.067	.615	.425	10, 14, 56
F-669-X	.895 .875	.989	2.003	.968	2.412	.275	.515	.075	.615	.425	14, 56, 38, 76, 12, 58
F-670-X	1.270 1.250	.989	2.003	.968	2.599	.275	.515	.075	.615	.425	14, 56, 38, 76, 12, 58, 34

NOTE: (MWID) denotes maximum wire insulation diameter.



TITLE: CUSTOMER DRAWING
 #4 WIRE-RANGE (F)
 RING TONGUE TERMINAL

DIMENSIONAL TOLERANCE
 UNLESS OTHERWISE SPECIFIED

FRAC.	DEC.	ANG.
±	±	±

REVISION		SCALE: _____	DATE
A	ETC2007-0019	DRWN. BY: JTK	1-21-70
		CHKD. BY:	
		APPRD. BY:	
		DRAWING NO.:	