

DDTA (R1-ONLY SERIES) KA

PNP PRE-BIASED SMALL SIGNAL SURFACE MOUNT TRANSISTOR

NEW PRODUCT

Features

- Epitaxial Planar Die Construction
- Complementary NPN Types Available (DDTC)
- Built-In Biasing Resistor, R1 only
- **Lead Free/RoHS Compliant (Note 2)**
- **"Green" Device (Note 3 and 4)**

Mechanical Data

- Case: SC-59
- Case Material: Molded Plastic, "Green" Molding Compound, Note 4. UL Flammability Classification Rating 94V-0
- Moisture Sensitivity: Level 1 per J-STD-020C
- Terminals: Solderable per MIL-STD-202, Method 208
- Lead Free Plating (Matte Tin Finish annealed over Copper leadframe).
- Terminal Connections: See Diagram
- Marking Information: See Table Below & Page 4
- Ordering Information: See Page 4
- Weight: 0.008 grams (approximate)

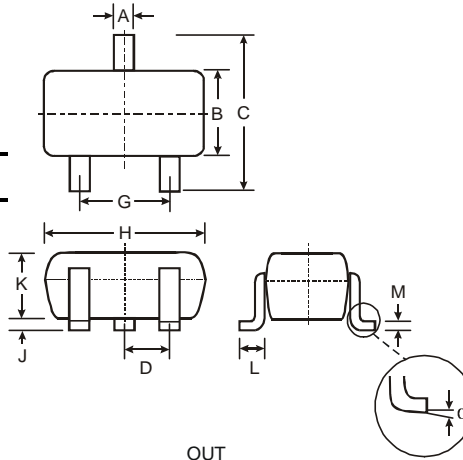

SC-59		
Dim	Min	Max
A	0.35	0.50
B	1.50	1.70
C	2.70	3.00
D	0.95	
G	1.90	
H	2.90	3.10
J	0.013	0.10
K	1.00	1.30
L	0.35	0.55
M	0.10	0.20
α	0°	8°
All Dimensions in mm		

P/N	R1 (NOM)	Type Code
DDTA113TKA	1K Ω	P01
DDTA123TKA	2.2K Ω	P03
DDTA143TKA	4.7K Ω	P07
DDTA114TKA	10K Ω	P12
DDTA124TKA	22K Ω	P16
DDTA144TKA	47K Ω	P19
DDTA115TKA	100K Ω	P23
DDTA125TKA	200K Ω	P25

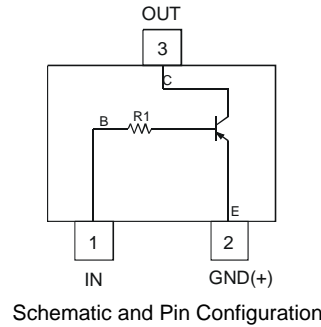

Maximum Ratings @T_A = 25°C unless otherwise specified

Characteristic	Symbol	Value	Unit
Collector-Base Voltage	V _{CB0}	-50	V
Collector-Emitter Voltage	V _{CEO}	-50	V
Emitter-Base Voltage	V _{EBO}	-5	V
Collector Current	I _C (Max)	-100	mA
Power Dissipation	P _d	200	mW
Thermal Resistance, Junction to Ambient Air (Note 1)	R _{θJA}	625	°C/W
Operating and Storage Temperature Range	T _j , T _{STG}	-55 to +150	°C

- Notes:
1. Mounted on FR4 PC Board with recommended pad layout at <http://www.diodes.com/datasheets/ap02001.pdf>.
 2. No purposefully added lead.
 3. Diodes Inc.'s "Green" policy can be found on our website at http://www.diodes.com/products/lead_free/index.php.
 4. Product manufactured with Date Code 0627 (week 27, 2006) and newer are built with Green Molding Compound. Product manufactured prior to Date Code 0627 are built with Non-Green Molding Compound and may contain Halogens or Sb2O3 Fire Retardants.

Electrical Characteristics @T_A = 25°C unless otherwise specified

Characteristic	Symbol	Min	Typ	Max	Unit	Test Condition
Collector-Base Breakdown Voltage	BV _{CBO}	-50	—	—	V	I _C = -50μA
Collector-Emitter Breakdown Voltage	BV _{CEO}	-50	—	—	V	I _C = -1mA
Emitter-Base Breakdown Voltage	BV _{EBO}	-5	—	—	V	I _E = -50μA
Collector Cutoff Current	I _{CBO}	—	—	-0.5	μA	V _{CB} = -50V
Emitter Cutoff Current	I _{EBO}	—	—	-0.5	μA	V _{EB} = -4V
Collector-Emitter Saturation Voltage	V _{CE(sat)}	—	—	-0.3	V	I _C /I _B = -10mA/-1mA DDTA113TKA I _C /I _B = -5mA/-0.5mA DDTA123TKA I _C /I _B = -2.5mA/-0.25mA DDTA143TKA I _C /I _B = -1mA/-0.1mA DDTA114TKA I _C /I _B = -5mA/-0.5mA DDTA124TKA I _C /I _B = -2.5mA/-0.25mA DDTA144TKA I _C /I _B = -1mA/-0.1mA DDTA115TKA I _C /I _B = -0.5mA/-0.05mA DDTA125TKA
DC Current Transfer Ratio	h _{FE}	100	250	600	—	I _C = -1mA, V _{CE} = -5V
Input Resistor (R ₁) Tolerance	ΔR ₁	-30	—	+30	%	—
Gain-Bandwidth Product*	f _T	—	250	—	MHz	V _{CE} = -10V, I _E = 5mA, f = 100MHz

* Transistor - For Reference Only

Typical Curves – DDTA114TKA

NEW PRODUCT

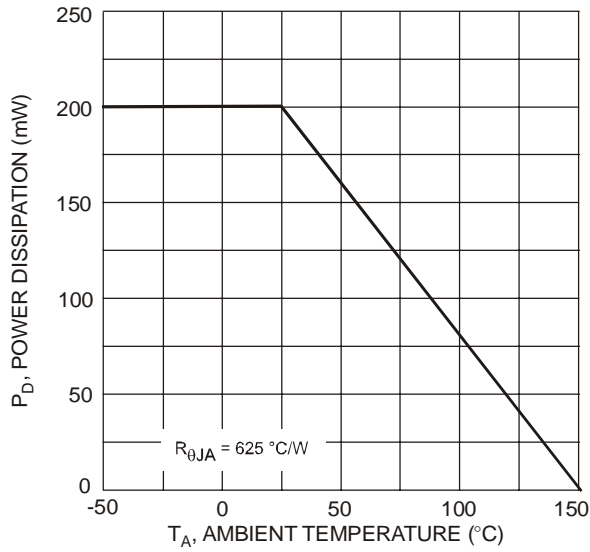

Fig. 1 Derating Curve

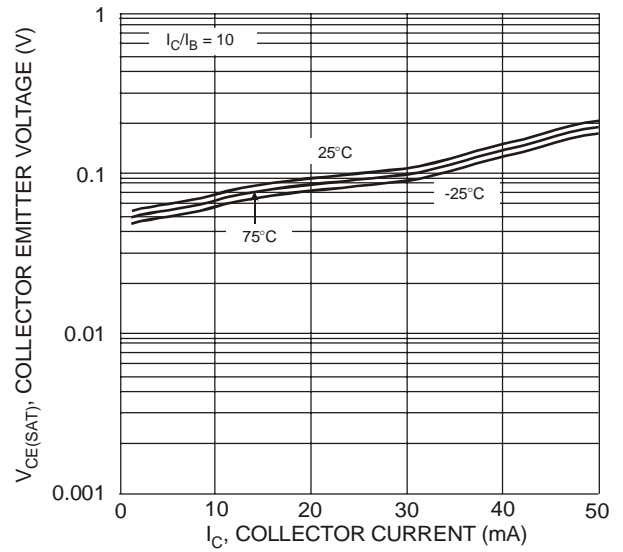

Fig. 2 V_{CE(SAT)} vs. I_C

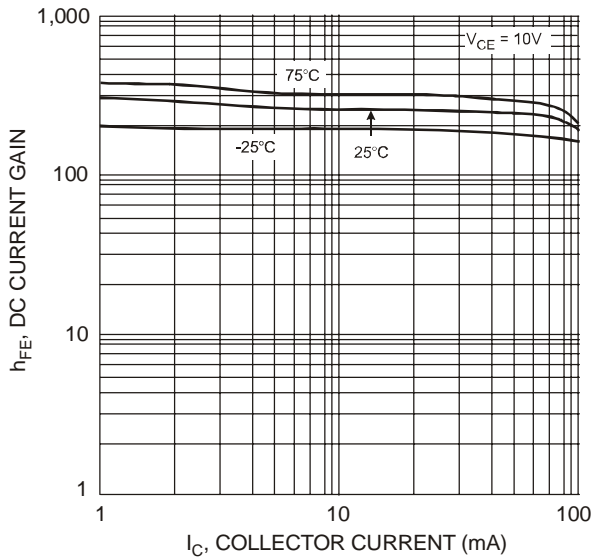

Fig. 3 DC Current Gain

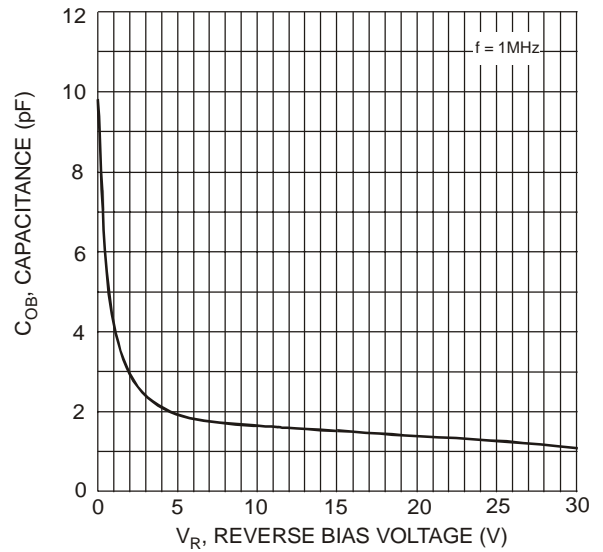

Fig. 4 Output Capacitance

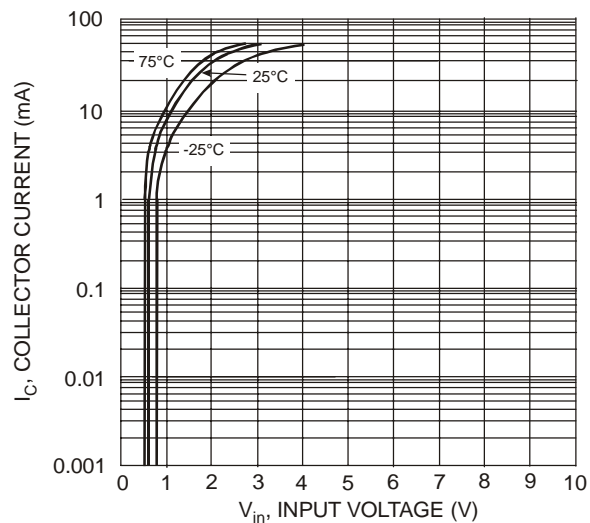

Fig. 5 Collector Current vs. Input Voltage

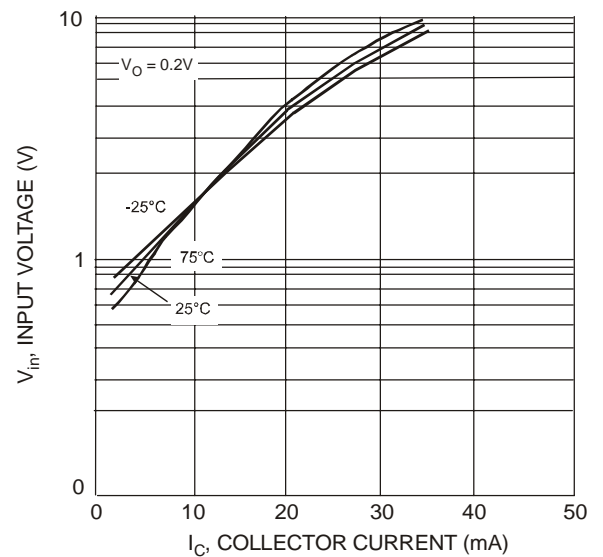

Fig. 6 Input Voltage vs. Collector Current

Ordering Information (Note 4 & 5)

Device	Packaging	Shipping
DDTA113TKA-7-F	SC-59	3000/Tape & Reel
DDTA123TKA-7-F	SC-59	3000/Tape & Reel
DDTA143TKA-7-F	SC-59	3000/Tape & Reel
DDTA114TKA-7-F	SC-59	3000/Tape & Reel
DDTA124TKA-7-F	SC-59	3000/Tape & Reel
DDTA144TKA-7-F	SC-59	3000/Tape & Reel
DDTA115TKA-7-F	SC-59	3000/Tape & Reel
DDTA125TKA-7-F	SC-59	3000/Tape & Reel

Notes: 5. For packaging details, go to our website at <http://www.diodes.com/datasheets/ap02007.pdf>.

Marking Information

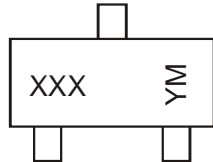

XXX = Product Type Marking Code, See Table on Page 1
 YM = Date Code Marking
 Y = Year ex: T = 2006
 M = Month ex: 9 = September

Date Code Key

Year	2006	2007	2008	2009	2010	2011	2012
Code	T	U	V	W	X	Y	Z

Month	Jan	Feb	Mar	Apr	May	Jun	Jul	Aug	Sep	Oct	Nov	Dec
Code	1	2	3	4	5	6	7	8	9	O	N	D

IMPORTANT NOTICE

Diodes Incorporated and its subsidiaries reserve the right to make modifications, enhancements, improvements, corrections or other changes without further notice to any product herein. Diodes Incorporated does not assume any liability arising out of the application or use of any product described herein; neither does it convey any license under its patent rights, nor the rights of others. The user of products in such applications shall assume all risks of such use and will agree to hold Diodes Incorporated and all the companies whose products are represented on our website, harmless against all damages.

LIFE SUPPORT

Diodes Incorporated products are not authorized for use as critical components in life support devices or systems without the expressed written approval of the President of Diodes Incorporated.