

PLEASE CHECK WWW.MOLEX.COM FOR LATEST PART INFORMATION

Part Number: [0436500915](#)
Status: **Active**
Overview: [microfit_30](#)
Description: 3.00mm (.118") Pitch Micro-Fit 3.0™ Header, Surface Mount Compatible, Single Row, Vertical, with PCB Polarizing Peg, 9 Circuits, Tin (Sn) Plating, Glow Wire Compatible

Documents:

3D Model	Product Specification PS-43650 (PDF)
Packaging Specification (PDF)	RoHS Certificate of Compliance (PDF)
Drawing (PDF)	

Agency Certification

CSA	LR19980
TUV	R72081037
UL	E29179

General

Product Family	PCB Headers
Series	43650
Application	Wire-to-Board
Comments	High Temperature Square Pin Offset Through Hole Mounting Solder Type
Overview	microfit_30
Product Literature Order No	USA-106
Product Name	Micro-Fit 3.0™

Physical

Breakaway	No
Circuits (Loaded)	9
Circuits (maximum)	9
Color - Resin	Black
Durability (mating cycles max)	30
Flammability	94V-0
Glow-Wire Compliant	Yes
Mated Height (in)	0.680 In
Mated Height (mm)	17.27 mm
Material - Metal	Brass
Material - Plating Mating	Tin
Material - Plating Termination	Tin
Material - Resin	High Temperature Thermoplastic
Number of Rows	1
Orientation	Vertical
PCB Locator	Yes
PCB Retention	Yes
PCB Thickness Recommended (in)	0.062 In
PCB Thickness Recommended (mm)	1.60 mm
Packaging Type	Tray
Pitch - Mating Interface (in)	0.118 In
Pitch - Mating Interface (mm)	3.00 mm
Plating min: Mating (µin)	100
Plating min: Mating (µm)	2.5
Plating min: Termination (µin)	100
Plating min: Termination (µm)	2.5
Polarized to PCB	Yes
Shrouded	Fully
Stackable	No

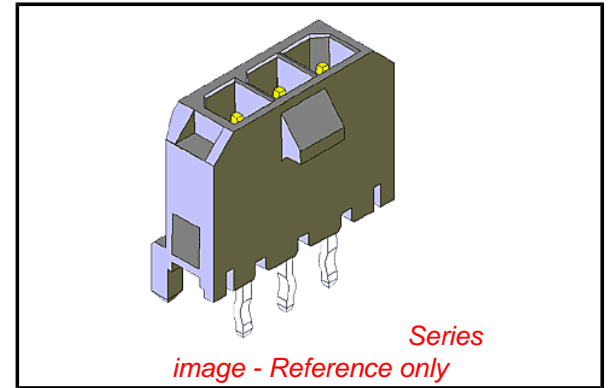

EU RoHS

ELV and RoHS Compliant
REACH SVHC Contains SVHC: No
Halogen-Free Status
Not Reviewed

China RoHS



Need more information on product environmental compliance?

Email productcompliance@molex.com
 For a multiple part number RoHS Certificate of Compliance, [click here](#)

Please visit the [Contact Us](#) section for any non-product compliance questions.

Search Parts in this Series

[43650Series](#)

Mates With

[43645 Micro-Fit 3.0™ Receptacle Housing](#)

Surface Mount Compatible (SMC)	Yes
Temperature Range - Operating	-40°C to +105°C
Termination Interface: Style	Through Hole - Kinked Pin

Electrical

Current - Maximum per Contact	5A
Voltage - Maximum	250V

Solder Process Data

Duration at Max. Process Temperature (seconds)	30
Lead-free Process Capability	SMC & Wave Capable (TH only)
Max. Cycles at Max. Process Temperature	3
Process Temperature max. C	260

Material Info

Reference - Drawing Numbers

Packaging Specification	PK-70873-0811
Product Specification	PS-43650
Sales Drawing	SD-43650-006

This document was generated on 05/24/2010

PLEASE CHECK WWW.MOLEX.COM FOR LATEST PART INFORMATION

13 12 11 10 9 8 7 6 5 4 3 2 1

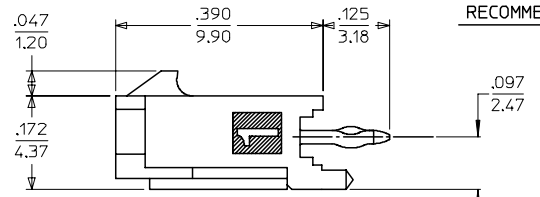
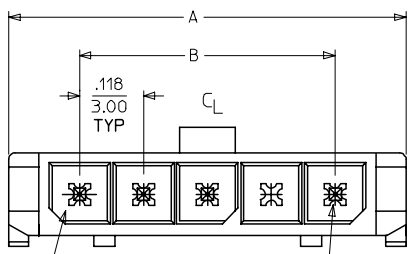
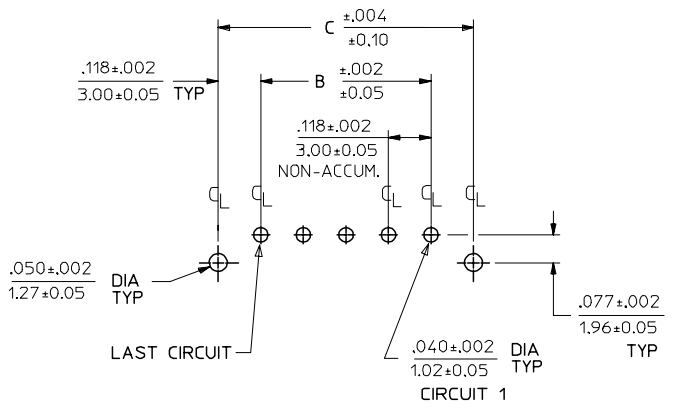
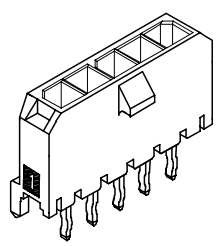
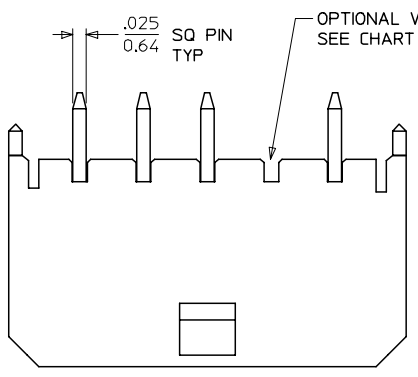

PCB LAYOUT: COMPONENT SIDE
RECOMMENDED PCB THICKNESS: .062/1.57

CKTS	A	B	C
2	.380 9.65	.118 3.00	.354 9.00
3	.498 12.65	.236 6.00	.472 12.00
4	.616 15.65	.354 9.00	.591 15.00
5	.734 18.64	.472 12.00	.709 18.00
6	.852 21.64	.591 15.00	.827 21.00
7	.970 24.64	.709 18.00	.945 24.00
8	1.088 27.64	.827 21.00	1.063 27.00
9	1.206 30.63	.945 24.00	1.181 30.00
10	1.325 33.66	1.063 27.00	1.299 33.00
11	1.443 36.65	1.181 30.00	1.417 36.00
12	1.561 39.65	1.299 33.00	1.535 39.00

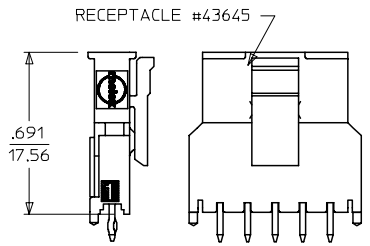
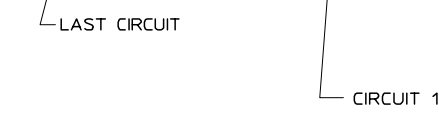

FINISH A			FINISH B			FINISH C		
CKTS	MATERIAL NO:	VOID CKT	CKTS	MATERIAL NO:	VOID CKT	CKTS	MATERIAL NO:	VOID CKT
02	43650-0215		02	43650-0216		02	43650-0217	
03	43650-0315		03	43650-0316		03	43650-0317	
04	43650-0415		04	43650-0416		04	43650-0417	
05	43650-0515		05	43650-0516		05	43650-0517	
06	43650-0615		06	43650-0616		06	43650-0617	
07	43650-0715		07	43650-0716		07	43650-0717	
08	43650-0815		08	43650-0816		08	43650-0817	
09	43650-0915		09	43650-0916		09	43650-0917	
10	43650-1015		10	43650-1016		10	43650-1017	
11	43650-1115		11	43650-1116		11	43650-1117	
12	43650-1215		12	43650-1216		12	43650-1217	
03	43650-0330	02	04	43650-0431	02,03	04	43650-0430	02,03
05	43650-9915	03						
05	43650-0530	02,04						
06	43650-0630	02,04,05						

- NOTES:
- HOUSING MATERIAL: LIQUID CRYSTAL POLYMER, GLASS FILLED, UL94V-0, COLOR: BLACK
TERMINAL MATERIAL: BRASS ALLOY
 - FINISH:
A = .000100/(0.00254) MIN. BRIGHT TIN OVER .000050/(0.00127) MIN. NICKEL
B = .000015/(0.00038) MIN. SELECT GOLD IN CONTACT AREA .000100/(0.00254) MIN. SELECT MATTE TIN ON SOLDER TAILS BOTH OVER .000050/(0.00127) NICKEL OVERALL
C = .000030/(0.00076) MIN. SELECT GOLD IN CONTACT AREA .000100/(0.00254) MIN. SELECT MATTE TIN ON SOLDER TAILS BOTH OVER .000050/(0.00127) NICKEL OVERALL
 - * THE PRIMARY SHIPPING CARTON WILL BE LABELED "COMPLIANT TO RoHS DIRECTIVE 2002/95/EC AND ELV ANNEX II OF DIRECTIVE 2000/53/EC." CARTONS WITHOUT THIS LABEL MAY CONTAIN PRODUCT WITH TIN/LEAD IN THE PC TAIL AREA.
 - PRODUCT SPECIFICATION: PS-43650
 - TRAY PACKAGED : SEE MOLEX DRAWING PK-70873-0811
 - MATES WITH MICRO FIT (3.0) RECEPTACLE SERIES 43645
 - A HIGHER TEMPERATURE GRADE MATERIAL (260C MAX. REFLOW TEMPERATURE) IS BEING PHASED-IN BEGINNING AUGUST 2007. PARTS WILL BE TEMPORARILY IDENTIFIED WITH A BLUE DOT ON THE PRIMARY SHIPPING CARTON LABEL UNTIL ALL CIRCUIT SIZES ARE CONVERTED, AT WHICH TIME A FULL-CONVERSION DATE WILL BE IDENTIFIED IN PS-43650.

691 DIM. ADD NOTE 6 EC NO: UCP2008-0037 DRAWN: KIPER 2007/09/06 CHKD: SSOUSEK 2007/09/11 APPR: FSM TH 2007/09/12	QUALITY SYMBOLS 	GENERAL TOLERANCES (UNLESS SPECIFIED) mm INCH		DIMENSION STYLE IN/MM		SCALE ---	DESIGN UNITS METRIC	THIRD ANGLE PROJECTION	
		4 PLACES ± --- ± --- 3 PLACES ± --- ± .010 2 PLACES ± 0.25 ± .014 1 PLACE ± 0.36 ± --- ANGULAR ±1/2°	DRAWN BY SAMIEC DATE 2000/07/07	CHECKED BY MUELLER DATE 2000/07/07	APPROVED BY EDGLEY DATE 2000/07/07	MATERIAL NO. SEE CHART		DOCUMENT NO. SD-43650-006	SHEET NO. 1 OF 1
DRAFT WHERE APPLICABLE MUST REMAIN WITHIN DIMENSIONS		MICRO-FIT (3.0) SINGLE ROW / VERTICAL THRU HOLE / PEGS / TRAY MOLEX INCORPORATED							
THIS DRAWING CONTAINS INFORMATION THAT IS PROPRIETARY TO MOLEX INCORPORATED AND SHOULD NOT BE USED WITHOUT WRITTEN PERMISSION									

12 11 10 9 8 7 6 5 4 3 2 1