

**Miniature Short Lever**

**Spade/Solder Type Terminal**

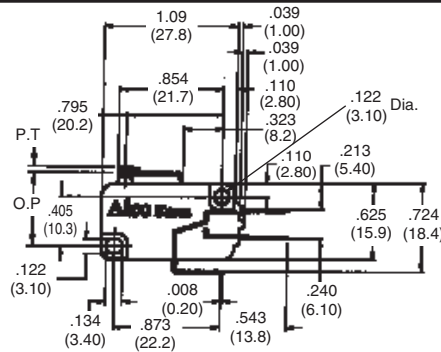

\* Refer to Pages L2 for Product Specifications

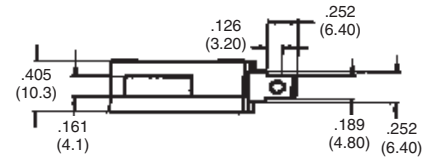

**Product Facts**

- n .187 [4.75] tab with solder hole
- n Use .187 [4.75] FASTON receptacles or solder wire directly to terminal
- n Short lever to increase operating position

AMP	Switch Position	Operating Force	Releasing Force	Pre Travel (P.T.)	Operating Position	Over Travel	Movement Differential	Part Number
16	SPDT	120g	20g	1.6 m/m [.063]	14.8 ±0.4 [.606±.016]	0.8 m/m [.031]	0.4 m/m [.016]	1478603-2
		200g	50g					1478604-2
		330g	70g					1478605-2
	SPNC	120g	20g	1.6 m/m [.063]	14.8 ±0.4 [.606±.016]	0.8 m/m [.031]	0.4 m/m [.016]	1478609-2
		200g	50g					1478610-2
		330g	70g					1478611-2
SPNO	120g	20g	1.6 m/m [.063]	14.8 ±0.4 [.606±.016]	0.8 m/m [.031]	0.4 m/m [.016]	1478615-2	
	200g	50g					1478616-2	
	330g	70g					1478617-2	
5	SPDT	120g	20g	1.6 m/m [.063]	14.8 ±0.4 [.606±.016]	0.8 m/m [.031]	0.4 m/m [.016]	1478667-2
	SPNC							1478668-2
	SPNO							1478669-2
0.1	SPDT	60g	12g	1.6 m/m [.063]	14.8 ±0.4 [.606±.016]	0.8 m/m [.031]	0.4 m/m [.016]	1478670-2
	SPNC							1478671-2
	SPNO							1478672-2

**Spade Type Terminal**

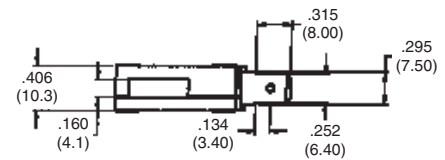
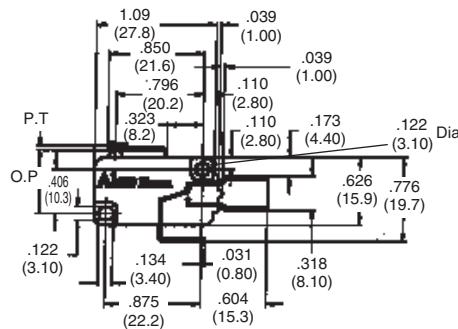

**Product Facts**

- n .250 [6.35] tab for use with .250 [6.35] FASTON receptacles
- n Short lever to increase operating positions

AMP	Switch Position	Operating Force	Releasing Force	Pre Travel (P.T.)	Operating Position	Over Travel	Movement Differential	Part Number
16	SPDT	120g	20g	1.6 m/m [.063]	15.4 ±0.4 [.606±.016]	0.8 m/m [.031]	0.4 m/m [.016]	1478606-2
		200g	50g					1478607-2
		330g	70g					1478608-2
	SPNC	120g	20g	1.6 m/m [.063]	15.4 ±0.4 [.606±.016]	0.8 m/m [.031]	0.4 m/m [.016]	1478612-2
		200g	50g					1478613-2
		330g	70g					1478614-2
SPNO	120g	20g	1.6 m/m [.063]	15.4 ±0.4 [.606±.016]	0.8 m/m [.031]	0.4 m/m [.016]	1478618-2	
	200g	50g					1478619-2	
	330g	70g					1478620-2	

**Miniature Normal Lever**

**Spade/Solder Type Terminal**

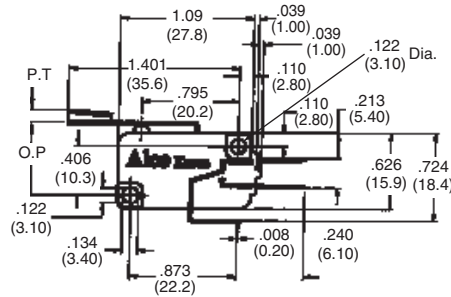
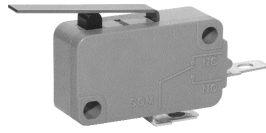

\* Refer to Pages L2 for Product Specifications

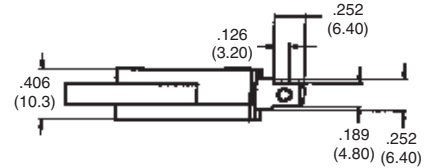

**Product Facts**

- n .187 [4.75] tab with solder hole
- n Use .187 [4.75] FASTON receptacles or solder wire directly to terminal
- n Lever to increase travel and operating position as well as reduce operating force

AMP	Switch Position	Operating Force	Releasing Force	Pre Travel (P.T.)	Operating Position	Over Travel	Movement Differential	Part Number
16	SPDT	60g	10g	4.0 m/m	15.4 ±1.4	1.3 m/m	1.2 m/m	1478603-3
		120g	20g	[.157]	[.606±.055]	[.051]	[.047]	1478604-3
		180g	30g					1478605-3
	SPNC	60g	10g	4.0 m/m	15.4 ±1.4	1.3 m/m	1.2 m/m	1478609-3
		120g	20g	[.157]	[.606±.055]	[.051]	[.047]	1478610-3
		180g	30g					1478611-3
SPNO	60g	10g	4.0 m/m	15.4 ±1.4	1.3 m/m	1.2 m/m	1478615-3	
	120g	20g	[.157]	[.606±.055]	[.051]	[.047]	1478616-3	
	180g	30g					1478617-3	
5	SPDT	60g	10g	4.0 m/m	15.4 ±1.4	1.3 m/m	1.2 m/m	1478667-3
	SPNC							1478668-3
	SPNO							1478669-3
0.1	SPDT	35g	6g	4.0 m/m	15.4 ±1.4	1.3 m/m	1.2 m/m	1478670-3
	SPNC							1478671-3
	SPNO							1478672-3

**Spade Type Terminal**

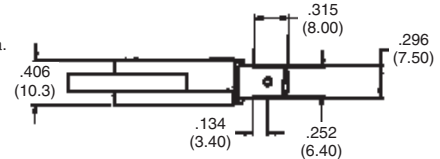
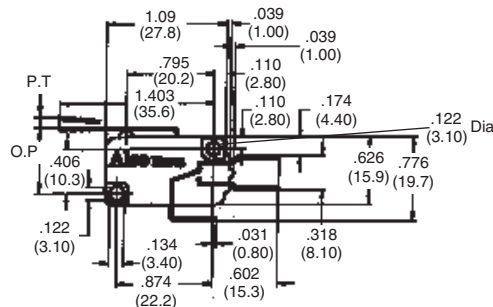
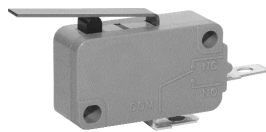

**Product Facts**

- n .250 [6.35] tab for use with .250 [6.35] FASTON receptacles
- n Lever to increase travel and operating position as well as reduce operating force

AMP	Switch Position	Operating Force	Releasing Force	Pre Travel (P.T.)	Operating Position	Over Travel	Movement Differential	Part Number
16	SPDT	60g	10g	4.0 m/m	15.4 ±1.4	1.3 m/m	1.2 m/m	1478606-3
		120g	20g	[.157]	[.606±.055]	[.051]	[.047]	1478607-3
		180g	30g					1478608-3
	SPNC	60g	10g	4.0 m/m	15.4 ±1.4	1.3 m/m	1.2 m/m	1478612-3
		120g	20g	[.157]	[.606±.055]	[.051]	[.047]	1478613-3
		180g	30g					1478614-3
SPNO	60g	10g	4.0 m/m	15.4 ±1.4	1.3 m/m	1.2 m/m	1478618-3	
	120g	20g	[.157]	[.606±.055]	[.051]	[.047]	1478619-3	
	180g	30g					1478620-3	