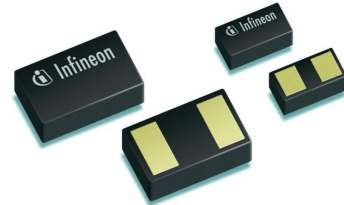

Silicon TVS Diode

- ESD / transient protection of data and power lines in low voltage applications according to:
IEC61000-4-2 (ESD): ± 25 kV (air) 20 kV (contact)
IEC61000-4-4 (EFT): 50 A / 2.5 kV (5/50 ns)
IEC61000-4-5 (surge): 5.5 A / 80 W (8/20 μ s)
- Small form factor (0402 inch):
1.0 x 0.6 x 0.4 mm³
- Bi-directional, symmetrical
working voltage up to ± 5.3 V
- Ultralow and symmetric clamping voltage
- Ultralow dynamic resistance **0.4 Ω**
- Very fast response time
- Pb-free (RoHS compliant) package
- Qualified according AEC Q101

Applications

Recommended to protect audio lines /
microphone lines / speaker and
headset systems in:

- Mobile phones
- Mobile TV
- Set top boxes
- MP3 players
- Minidisc players
- Portable entertainment electronics

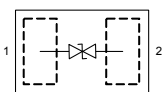
ESD5V3S1B-02LRH

Type	Package	Configuration	Marking
ESD5V3S1B-02LRH	TSLP-2-17	1 line, bi-directional	E1

Maximum Ratings at $T_A = 25^\circ\text{C}$, unless otherwise specified

Parameter	Symbol	Value	Unit
ESD air / contact discharge ¹⁾	V_{ESD}	25 / 20	kV
Peak pulse current ($t_p = 8 / 20 \mu\text{s}$) ²⁾	I_{pp}	5.5	A
Peak pulse power ($t_p = 8 / 20 \mu\text{s}$) ²⁾	P_{pk}	80	W
Operating temperature range	T_{op}	-55...125	°C
Storage temperature	T_{stg}	-65...150	

Electrical Characteristics at $T_A = 25^\circ\text{C}$, unless otherwise specified

Parameter	Symbol	Values			Unit
		min.	typ.	max.	

Characteristics

Reverse working voltage	V_{RWM}	-5.3	-	5.3	V	
Breakdown voltage $I_{(\text{BR})} = 1 \text{ mA}$	$V_{(\text{BR})}$	6	-	-		
Reverse current $V_R = 3.3 \text{ V}$	I_R	-	-	0.1	μA	
Clamping voltage $I_{\text{PP}} = 1 \text{ A}, t_p = 8/20 \mu\text{s}$ ²⁾ $I_{\text{PP}} = 3.5 \text{ A}, t_p = 8/20 \mu\text{s}$ ²⁾ $I_{\text{PP}} = 5.5 \text{ A}, t_p = 8/20 \mu\text{s}$ ²⁾	V_{CL}	-	8 10 11	10 12 13	V	
Diode capacitance $V_R = 0 \text{ V}, f = 1 \text{ MHz}$ $V_R = 2.5 \text{ V}, f = 1 \text{ MHz}$	C_T	-	17.5 14.5	20 -		pF
Dynamic resistance ³⁾ ($t_p = 30 \text{ ns}$)	R_D	-	0.4	-		

¹⁾ V_{ESD} according to IEC61000-4-2

²⁾ I_{pp} according to IEC61000-4-5

³⁾ according to TLP tests

Power derating curve $P_{pk} = f(T_A)$

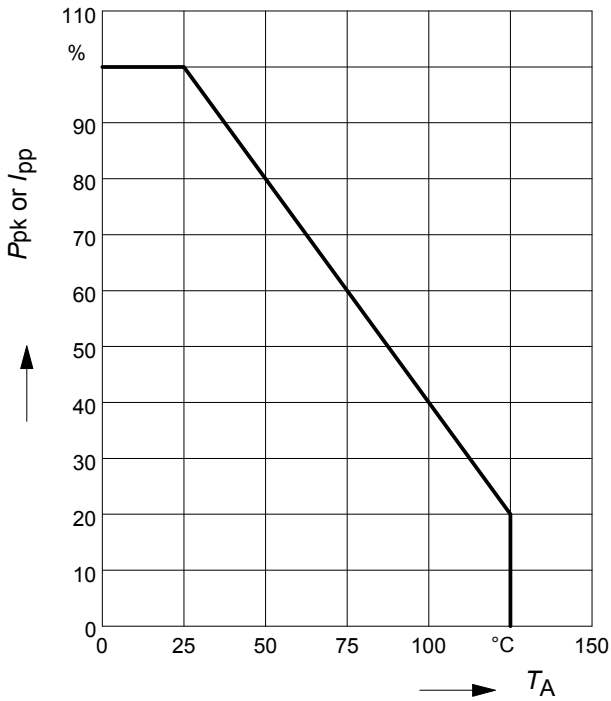

Clamping voltage, $V_{cl} = f(I_{pp})$

$t_p = 8 / 20 \mu s$

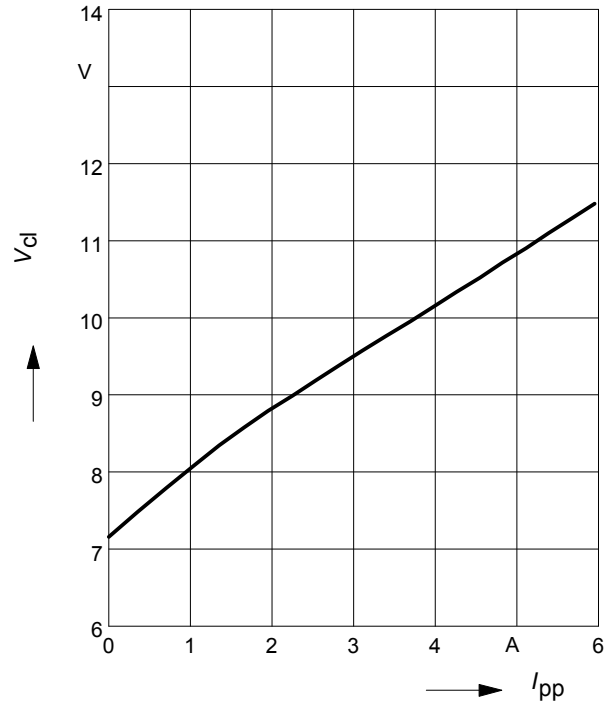

Reverse current $I_R = f(T_A)$

$V_R = 3.3 V$

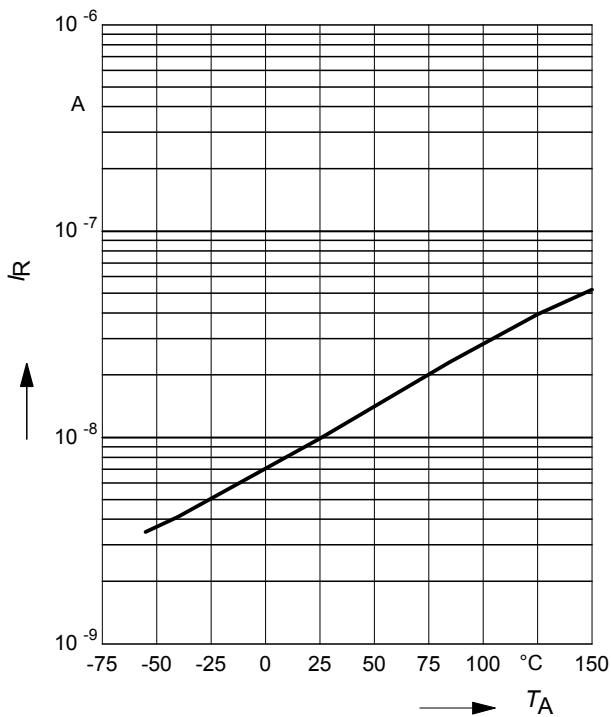

Breakdown voltage $V_{BR} = f(T_A)$

$I_R = 1 mA$

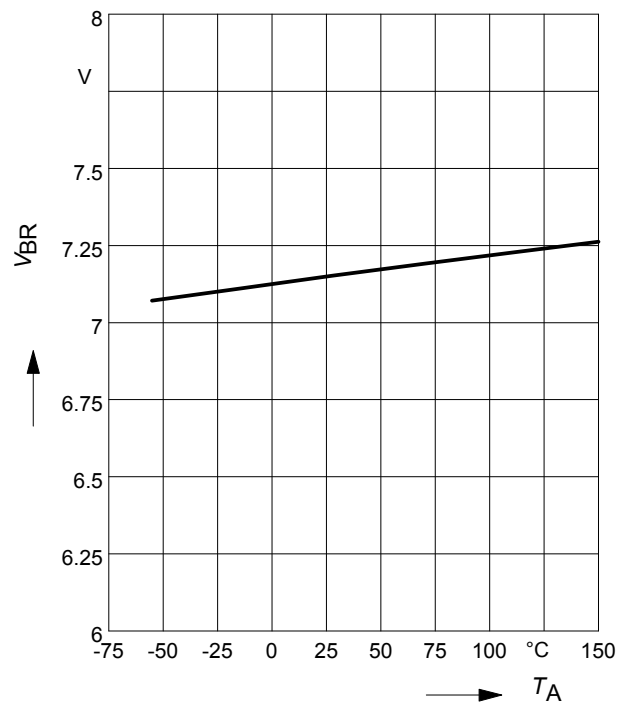

Diode capacitance $C_T = f(V_R)$

$f = 1\text{MHz}$

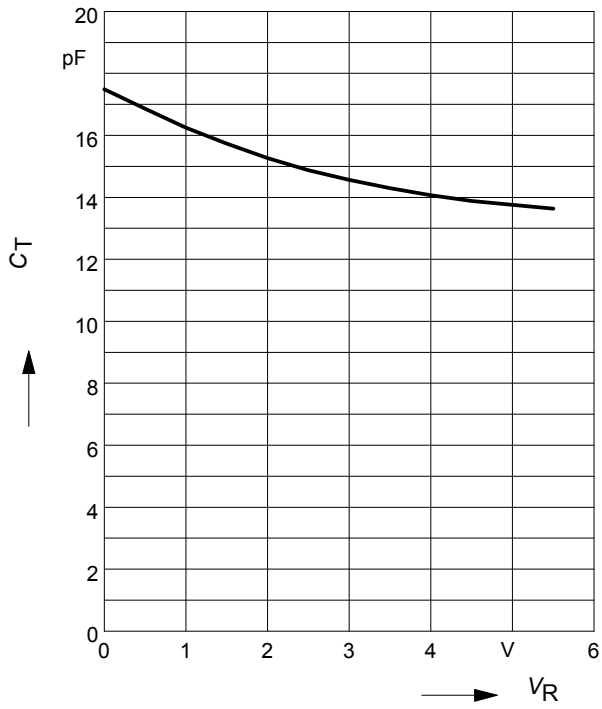

Application example
single channel, bi-directional

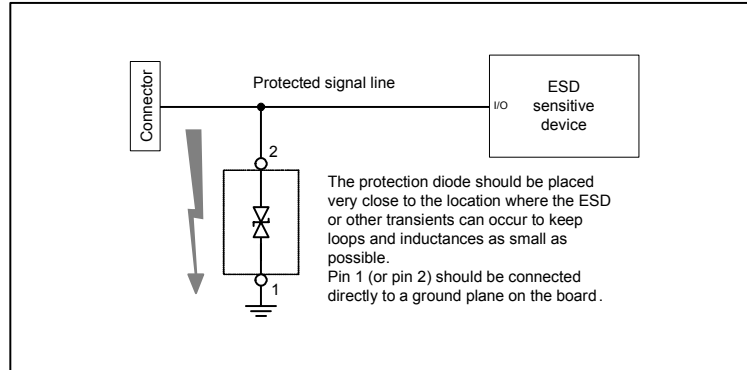

Package Outline

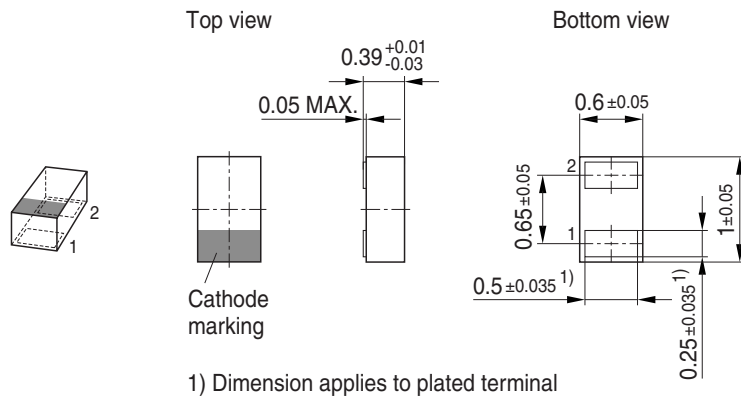

Foot Print

For board assembly information please refer to Infineon website "Packages"

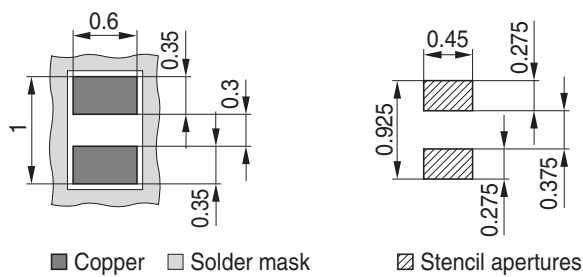

Marking Layout (Example)

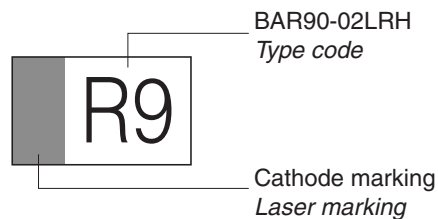

Standard Packing

Reel ø180 mm = 15.000 Pieces/Reel
 Reel ø330 mm = 50.000 Pieces/Reel (optional)

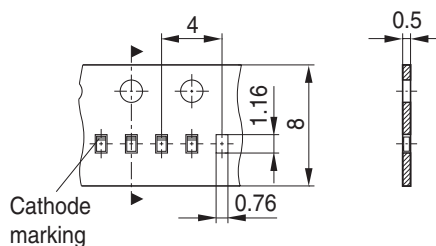

Edition 2009-11-16

**Published by
Infineon Technologies AG
81726 Munich, Germany**

**© 2009 Infineon Technologies AG
All Rights Reserved.**

Legal Disclaimer

The information given in this document shall in no event be regarded as a guarantee of conditions or characteristics. With respect to any examples or hints given herein, any typical values stated herein and/or any information regarding the application of the device, Infineon Technologies hereby disclaims any and all warranties and liabilities of any kind, including without limitation, warranties of non-infringement of intellectual property rights of any third party.

Information

For further information on technology, delivery terms and conditions and prices, please contact the nearest Infineon Technologies Office (www.infineon.com).

Warnings

Due to technical requirements, components may contain dangerous substances. For information on the types in question, please contact the nearest Infineon Technologies Office.

Infineon Technologies components may be used in life-support devices or systems only with the express written approval of Infineon Technologies, if a failure of such components can reasonably be expected to cause the failure of that life-support device or system or to affect the safety or effectiveness of that device or system. Life support devices or systems are intended to be implanted in the human body or to support and/or maintain and sustain and/or protect human life. If they fail, it is reasonable to assume that the health of the user or other persons may be endangered.