

## FKP252

December, 2005

## ■Features

- Low on-resistance
- Low input capacitance
- Avalanche energy capability guaranteed

## ■Applications

- PDP driving
- High speed switching

## ■Equivalent circuit

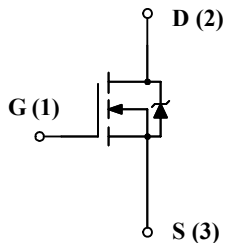

## ■Package---TO220F

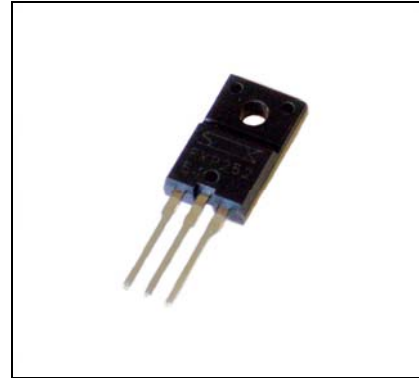
Absolute maximum ratings

(Ta=25°C)

Characteristic	Symbol	Rating	Unit
Drain to Source Voltage	VDSS	250	V
Gate to Source Voltage	VGSS	±30	V
Continuous Drain Current	ID	±25A	A
Pulsed Drain Current	ID(pulse) <sup>*1</sup>	±100A	A
Maximum Power Dissipation	PD	40 (Tc=25°C)	W
Single Pulse Avalanche Energy	EAS <sup>*2</sup>	200	mJ
Avalanche Current	IAS	25	A
Channel Temperature	Tch	150	°C
Storage Temperature	Tstg	-55 to 150	°C

\*1 PW≤100μsec, duty cycle≤1%

\*2 VDD=20V, L=590μH, ILp=25A, unclamped, RG=50Ω, See Fig.1

## FKP252

December, 2005

**Electrical characteristics**

(Ta=25°C)

Characteristic	Symbol	Test Conditions	Limits			Unit
			MIN.	TYP.	MAX.	
Drain to Source breakdown Voltage	V(BR)DSS	ID=100μA, VGS=0V	250			V
Gate to Source Leakage Current	IGSS	VGS=±30V			±100	nA
Drain to Source Leakage Current	IDSS	VDS=250V, VGS=0V			100	μA
Gate Threshold Voltage	VTH	VDS=10V, ID=1mA	3.0		4.5	V
Forward Transconductance	Re(Yfs)	VDS=10V, ID=12A	13	21		S
Static Drain to Source On-Resistance	RDS(ON)	ID=12A, VGS=10V		68	75	mΩ
Input Capacitance	Ciss	VDS=25V		2000		pF
Output Capacitance	Coss	VGS=0V		330		
Reverse Transfer Capacitance	Crss	f=1MHz		70		
Turn-On Delay Time	td(on)	ID=12A, VDD≈120V		30		ns
Rise Time	tr	RL=10Ω, VGS=10V		50		
Turn-Off Delay Time	td(off)	Rg=5Ω		100		
Fall Time	tf	See Fig.2		40		
Source-Drain Diode Forward Voltage	VSD	ISD=25A, VGS=0V		0.9	1.5	V
Gate Threshold Voltage Temp. Coefficient	ΔVTH / ΔTch	VDS=10V, ID=1mA		-8		mV/°C

## Characteristic Curves (Tc=25°C)

**ID-VDS Characteristics (typical)**

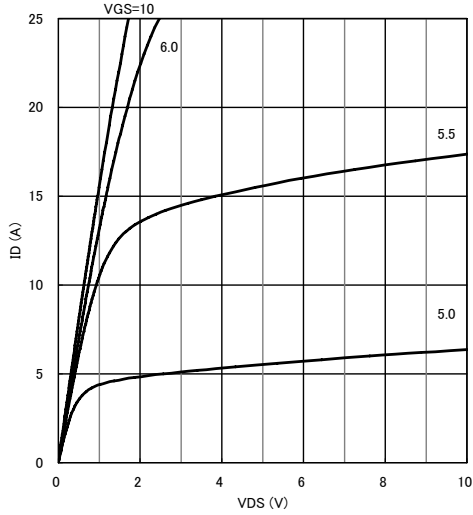

**ID-VGS Characteristics (typical)**

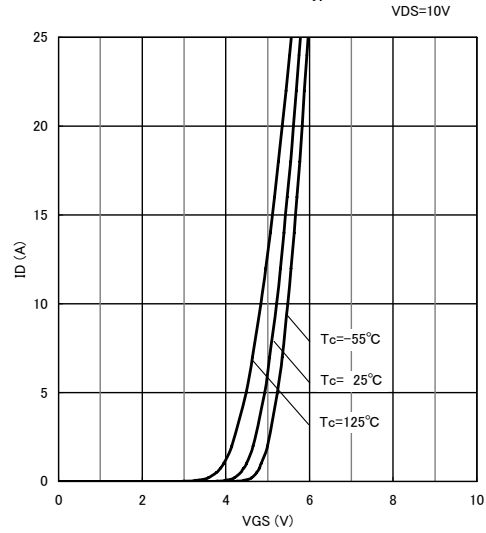

**RDS(on)-ID Characteristics (typical)**

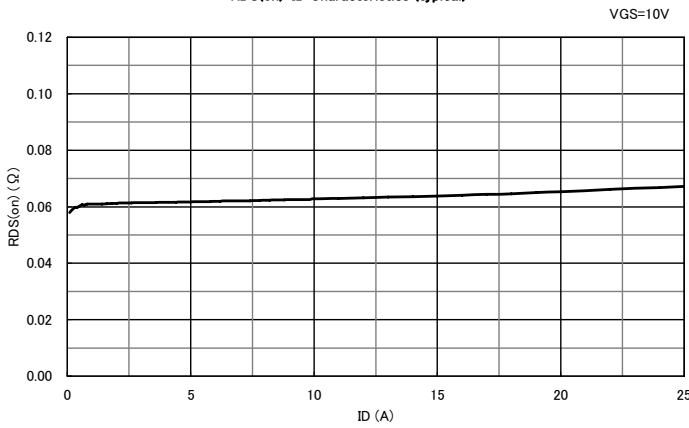

**VDS-VGS Characteristics (typical)**

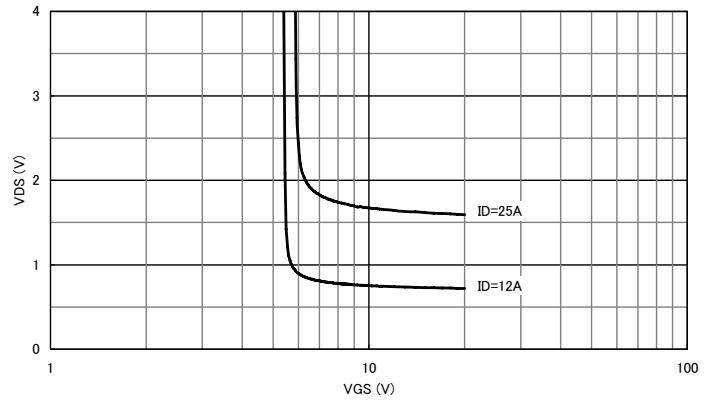

**RDS(on) -Tc Characteristics (typical)**

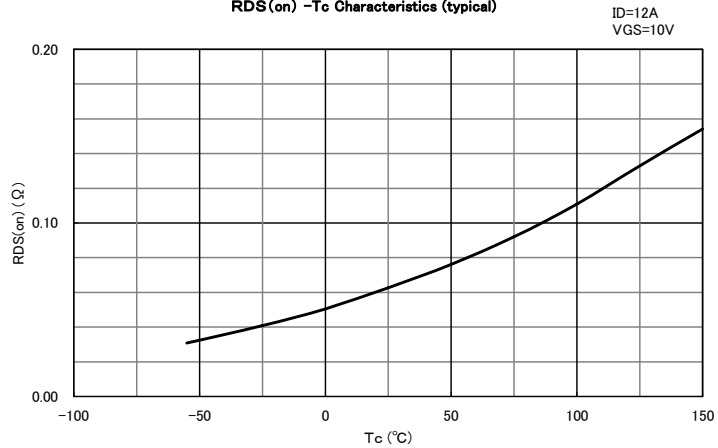

## Characteristic Curves (Tc=25°C)

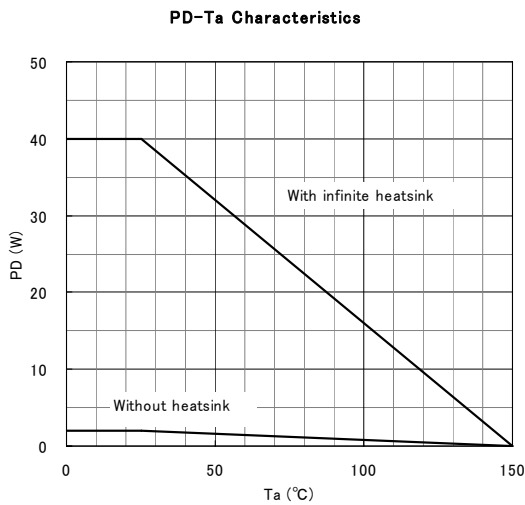
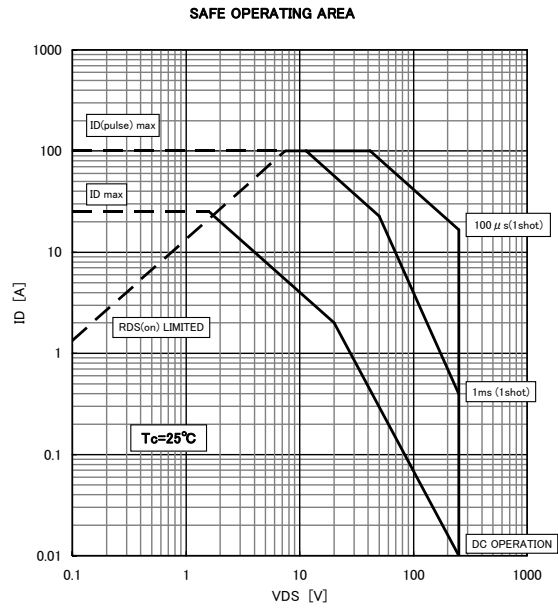
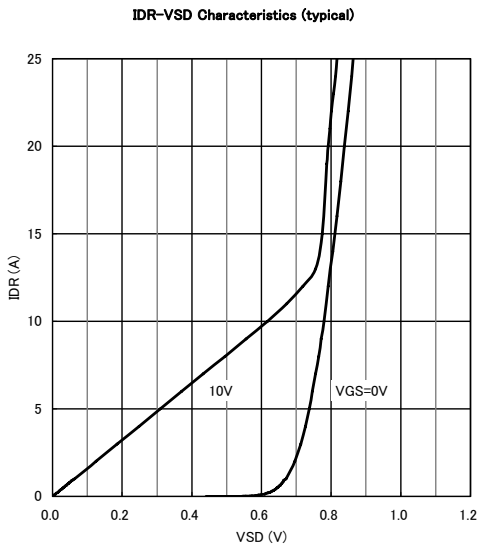
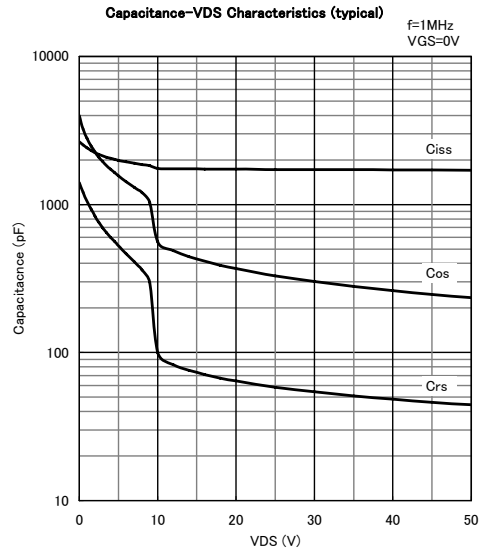
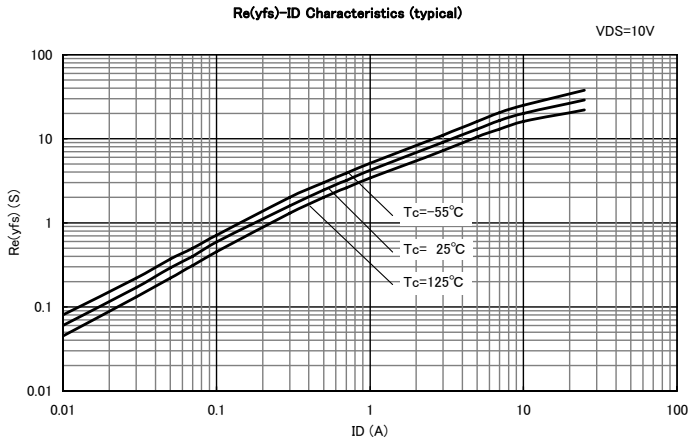

Fig.1 Unclamped Inductive Test Method (for Avalanche energy capability)

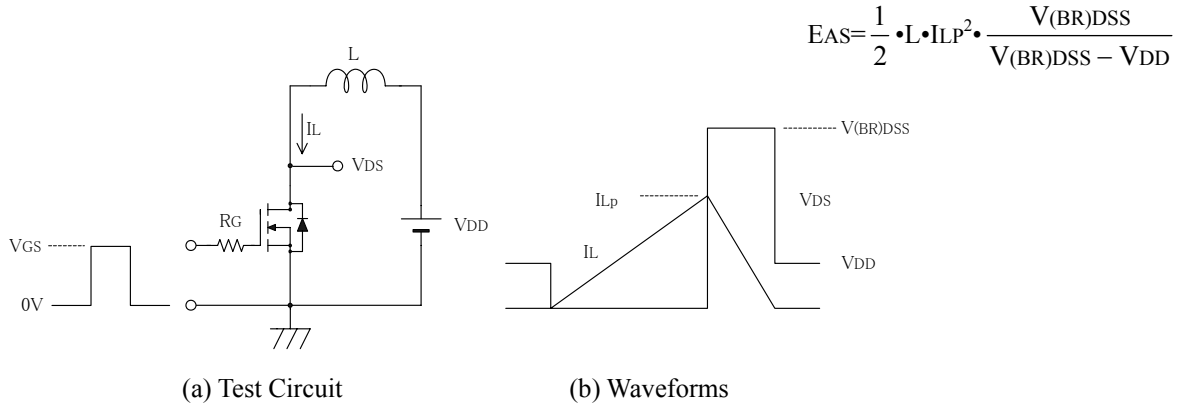
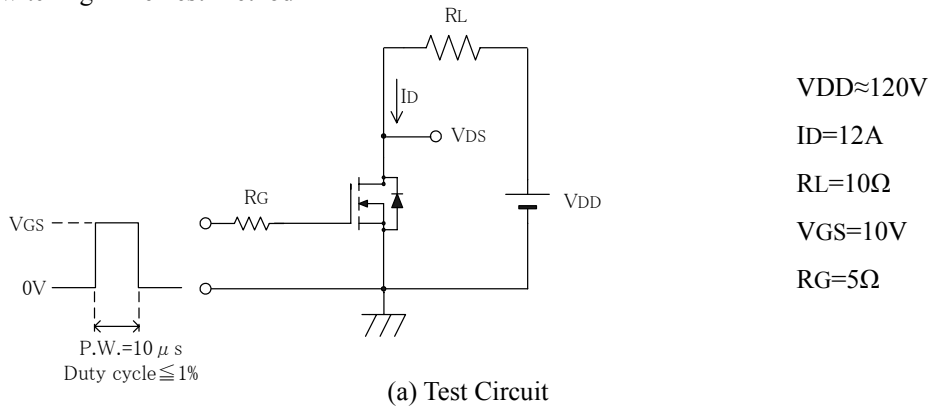

Fig.2 Switching Time Test Method



# FKP252

December, 2005

## External Dimensions

FM20 (TO220 Full Mold)

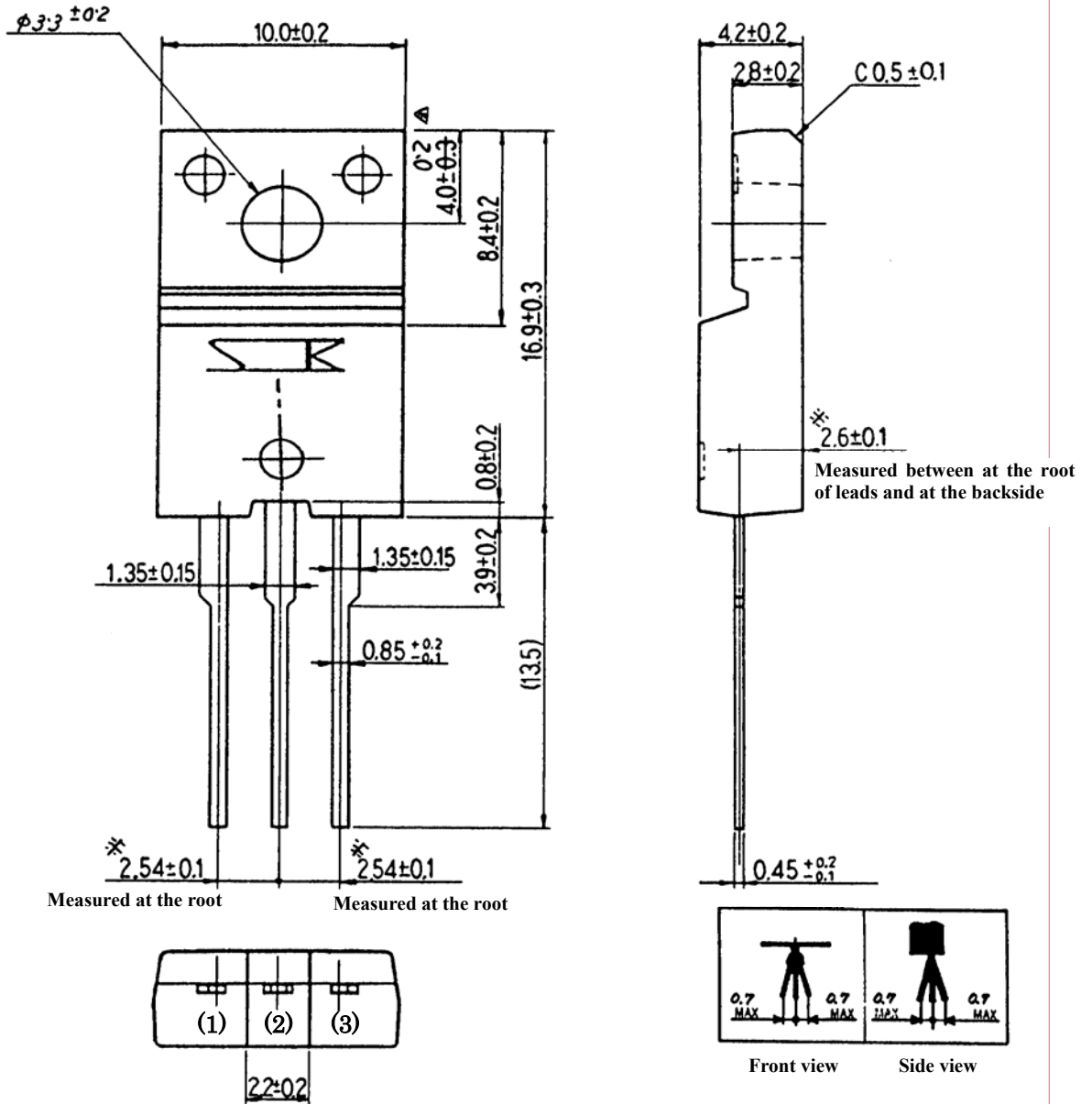

Mass: Approx. 2g

## &lt;Worldwide Contacts&gt;

**Asia Pacific****China****Sanken Electric Hong Kong Co., Ltd.**

Suite 1026 Ocean Centre, Canton Road, Tsimshatsui, Kowloon, Hong Kong

Tel: 852-2735-5262

Fax: 852-2735-5494

**Sanken Electric (Shanghai) Co., Ltd.**

Room3202, Maxdo Centre, Xingyi Road 8, Changning district, Shanghai, China

Tel: 86-21-5208-1177

Fax: 86-21-5208-1757

**Taiwan Sanken Electric Co., Ltd.**

Room 1801, 18th Floor, 88 Jung Shiau East Road, Sec. 2, Taipei 100, Taiwan R.O.C.

Tel: 886-2-2356-8161

Fax: 886-2-2356-8261

**India****Saket Devices Pvt. Ltd.**

Office No.13, First Floor, Bandal - Dhankude Plaza, Near PMT Depot, Paud Road, Kothrud, Pune - 411 038, India

Tel: 91-20-5621-2340

91-20-2528-5449

Fax: 91-20-2528-5459

**Japan****Sanken Electric Co., Ltd. Overseas Sales Headquarters**

Metropolitan Plaza Bldg. 1-11-1 Nishi-Ikebukuro, Toshima-ku, Tokyo 171-0021, Japan

Tel: 81-3-3986-6164

Fax: 81-3-3986-8637

**Korea****Sanken Electric Korea Co., Ltd.**

Mirae Asset Life Bldg. 6F, 168 Kongduk-dong, Mapo-ku, Seoul, 121-705, Korea

Tel: 82-2-714-3700

Fax: 82-2-3272-2145

**Singapore****Sanken Electric Singapore Pte. Ltd.**

150 Beach Road, #14-03 The Gateway West, Singapore 189720

Tel: 65-6291-4755

Fax: 65-6297-1744

## Europe

### United Kingdom

#### **Sanken Power Systems (UK) Limited**

Pencoed Technology Park, Pencoed, Bridgend CF35 5HY. UK

Tel: 44-1656-869-100

Fax: 44-1656-869-162

## North America

### United States

#### **Allegro MicroSystems, Inc.**

115 Northeast Cutoff, Worcester, Massachusetts 01606, U.S.A.

Tel: 1-508-853-5000

Fax: 1-508-853-3353

#### **Allegro MicroSystems, Inc. (Southern California)**

14 Hughes Street, Suite B105, Irvine, CA 92618

Tel: 1-949-460-2003

Fax: 1-949-460-7837



## CAUTION / WARNING

- The information in this publication has been carefully checked and is believed to be accurate; however, no responsibility is assumed for inaccuracies.

- Sanken reserves the right to make changes without further notice to any products herein in the interest of improvements in the performance, reliability, or manufacturability of its products.

Before placing an order, Sanken advises its customers to obtain the latest version of the relevant information to verify that the information being relied upon is current.

- Application and operation examples described in this catalog are quoted for the sole purpose of reference for the use of the products herein and Sanken can assume no responsibility for any infringement of industrial property rights, intellectual property rights or any other rights of Sanken or any third party which may result from its use.
- When using the products herein, the applicability and suitability of such products for the intended purpose or object shall be reviewed at the users' responsibility.

- Although Sanken undertakes to enhance the quality and reliability of its products, the occurrence of failure and defect of semiconductor products at a certain rate is inevitable. Users of Sanken products are requested to take, at their own risk, preventative measures including safety design of the equipment or systems against any possible injury, death, fires or damages to the society due to device failure or malfunction.

- Sanken products listed in this catalog are designed and intended for the use as components in general purpose electronic equipment or apparatus (home appliances, office equipment, telecommunication equipment, measuring equipment, etc.). Before placing an order, the user's written consent to the specifications is requested.

When considering the use of Sanken products in the applications where higher reliability is required (transportation equipment and its control systems, traffic signal control systems or equipment, fire/crime alarm systems, various safety devices, etc.), please contact your nearest Sanken sales representative to discuss and obtain written confirmation of your specifications. The use of Sanken products without the written consent of Sanken in the applications where extremely high reliability is required (aerospace equipment, nuclear power control systems, life support systems, etc.) is strictly prohibited.

- Anti radioactive ray design is not considered for the products listed herein.
- This publication shall not be reproduced in whole or in part without prior written approval from Sanken.

- This is notification that you, as purchaser of the products/technology, are not allowed to perform any of the following:

1. Resell or retransfer these products/technology to any party intending to disturb international peace and security.
2. Use these products/technology yourself for activities disturbing international peace and security.
3. Allow any other party to use these products/technology for activities disturbing international peace and security.

Also, as purchaser of these products/technology, you agree to follow the procedures for the export or transfer of these products/technology, under the Foreign Exchange and Foreign Trade Law, when you export or transfer the products/technology abroad.