

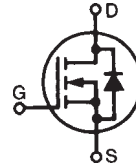
# HiPerFET™ Power MOSFETs Q-Class

IXFB 72N55Q2

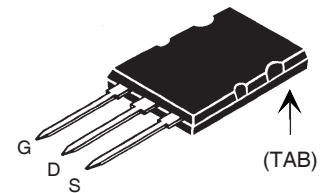
$V_{DSS} = 550 \text{ V}$   
 $I_{D25} = 72 \text{ A}$   
 $R_{DS(on)} = 72 \text{ m}\Omega$   
 $t_{rr} \leq 250 \text{ ns}$

N-Channel Enhancement Mode  
 Avalanche Rated, Low  $Q_g$ , Low Intrinsic  $R_g$   
 High  $dV/dt$ , Low  $t_{rr}$

Preliminary Data Sheet



PLUS 264™ (IXFB)



G = Gate                      D = Drain  
 S = Source                    TAB = Drain

Symbol	Test Conditions	Maximum Ratings	
$V_{DSS}$	$T_J = 25^\circ\text{C}$ to $150^\circ\text{C}$	550	V
$V_{DGR}$	$T_J = 25^\circ\text{C}$ to $150^\circ\text{C}$ ; $R_{GS} = 1 \text{ M}\Omega$	550	V
$V_{GS}$	Continuous	$\pm 30$	V
$V_{GSM}$	Transient	$\pm 40$	V
$I_{D25}$	$T_C = 25^\circ\text{C}$	72	A
$I_{DM}$	$T_C = 25^\circ\text{C}$ , pulse width limited by $T_{JM}$	284	A
$I_{AR}$	$T_C = 25^\circ\text{C}$	72	A
$E_{AR}$	$T_C = 25^\circ\text{C}$	60	mJ
$E_{AS}$	$T_C = 25^\circ\text{C}$	5.0	J
$dv/dt$	$I_S \leq I_{DM}$ , $di/dt \leq 100 \text{ A}/\mu\text{s}$ , $V_{DD} \leq V_{DSS}$ $T_J \leq 150^\circ\text{C}$ , $R_G = 2 \Omega$	20	V/ns
$P_D$	$T_C = 25^\circ\text{C}$	890	W
$T_J$		-55 ... +150	$^\circ\text{C}$
$T_{JM}$		150	$^\circ\text{C}$
$T_{stg}$		-55 ... +150	$^\circ\text{C}$
$T_L$	1.6 mm (0.063 in.) from case for 10 s	300	$^\circ\text{C}$
$F_c$	Mounting Force	30...120/7.5...27 N/lb	
<b>Weight</b>		10	g

### Features

- Double metal process for low gate resistance
- Unclamped Inductive Switching (UIS) rated
- Low package inductance  
- easy to drive and to protect
- Fast intrinsic rectifier

### Applications

- DC-DC converters
- Switched-mode and resonant-mode power supplies, >500kHz switching
- DC choppers
- Pulse generation
- Laser drivers

### Advantages

- PLUS 264™ package for clip or spring mounting
- Space savings
- High power density

Symbol	Test Conditions	Characteristic Values ( $T_J = 25^\circ\text{C}$ , unless otherwise specified)		
		min.	typ.	max.
$V_{DSS}$	$V_{GS} = 0 \text{ V}$ , $I_D = 1 \text{ mA}$	550		V
$V_{GS(th)}$	$V_{DS} = V_{GS}$ , $I_D = 8 \text{ mA}$	2.5		5.0 V
$I_{GSS}$	$V_{GS} = \pm 30 \text{ V}$ , $V_{DS} = 0$			$\pm 200 \text{ nA}$
$I_{DSS}$	$V_{DS} = V_{DSS}$ $V_{GS} = 0 \text{ V}$		$T_J = 25^\circ\text{C}$ $T_J = 125^\circ\text{C}$	100 $\mu\text{A}$ 5 mA
$R_{DS(on)}$	$V_{GS} = 10 \text{ V}$ , $I_D = 0.5 \cdot I_{D25}$ Note 1			72 m $\Omega$

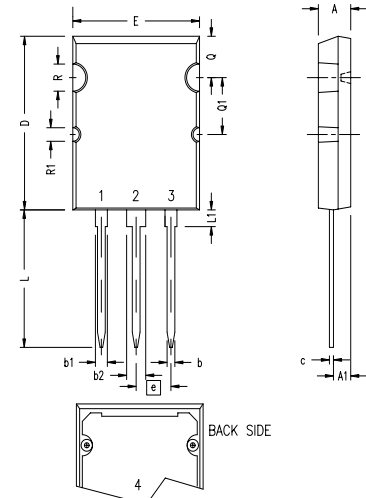
Symbol	Test Conditions	Characteristic Values ( $T_J = 25^\circ\text{C}$ , unless otherwise specified)		
		min.	typ.	max.
$g_{fs}$	$V_{DS} = 10\text{ V}; I_D = 0.5 \cdot I_{D25}$ Note 1	40	57	S
$C_{iss}$	$V_{GS} = 0\text{ V}, V_{DS} = 25\text{ V}, f = 1\text{ MHz}$		10500	pF
$C_{oss}$			1500	pF
$C_{rss}$			230	pF
$t_{d(on)}$	$V_{GS} = 10\text{ V}, V_{DS} = 0.5 \cdot V_{DSS}, I_D = 0.5 \cdot I_{D25}$ $R_G = 1\ \Omega$ (External)		30	ns
$t_r$			23	ns
$t_{d(off)}$			58	ns
$t_f$			10	ns
$Q_{g(on)}$	$V_{GS} = 10\text{ V}, V_{DS} = 0.5 \cdot V_{DSS}, I_D = 0.5 \cdot I_{D25}$		258	nC
$Q_{gs}$			65	nC
$Q_{gd}$			123	nC
$R_{thJC}$			0.14	K/W
$R_{thCK}$			0.13	K/W

### Source-Drain Diode

Symbol	Test Conditions	Characteristic Values ( $T_J = 25^\circ\text{C}$ , unless otherwise specified)		
		min.	typ.	max.
$I_S$	$V_{GS} = 0\text{ V}$			72 A
$I_{SM}$	Repetitive; pulse width limited by $T_{JM}$			288 A
$V_{SD}$	$I_F = I_S, V_{GS} = 0\text{ V}$ , Note 1			1.5 V
$t_{rr}$	$I_F = 25\text{ A}$ $-di/dt = 100\text{ A}/\mu\text{s}$ $V_R = 100\text{ V}$			250 ns
$Q_{RM}$			1.2	$\mu\text{C}$
$I_{RM}$			8	A

Note: 1. Pulse test,  $t \leq 300\ \mu\text{s}$ , duty cycle  $d \leq 2\%$

### PLUS 264™ Outline



Terminals: 1 - Gate  
2 - Drain (Collector)  
3 - Source (Emitter)  
4 - Drain (Collector)

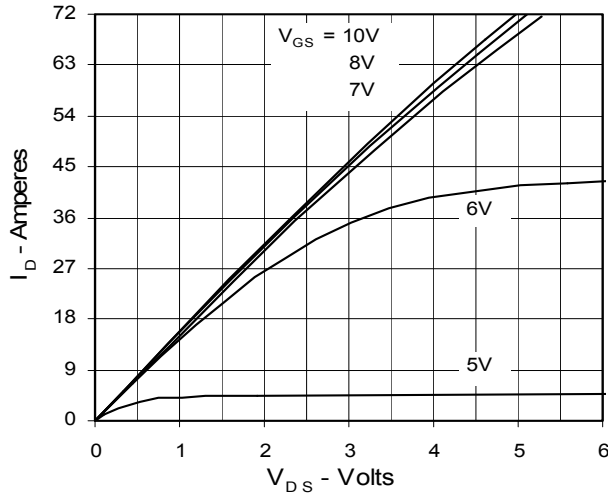
SYM	INCHES	
	MIN	MAX
A	.185	.209
A1	.102	.118
b	.037	.055
b1	.087	.102
b2	.110	.126
c	.017	.029
D	1.007	1.047
E	.760	.799
e	.215 BSC	
L	.779	.842
L1	.087	.102
Q	.240	.256
Q1	.330	.346
$\varnothing R$	.155	.187
$\varnothing R1$	.085	.093

IXYS reserves the right to change limits, test conditions, and dimensions.

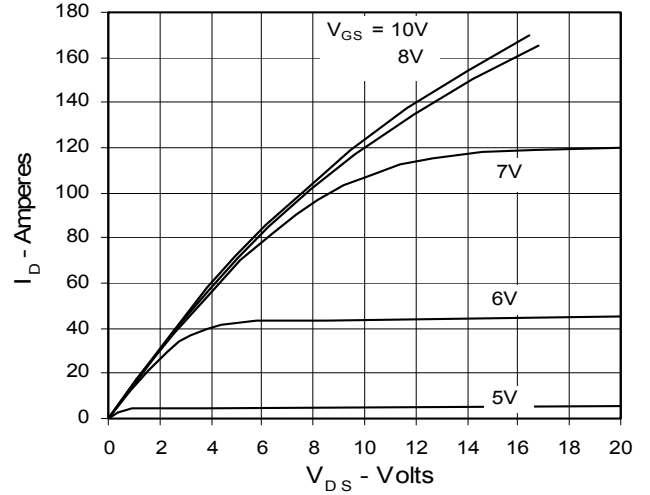
IXYS MOSFETs and IGBTs are covered by one or more of the following U.S. patents:

4,835,592 4,881,106 5,017,508 5,049,961 5,187,117 5,486,715 6,306,728B1 6,259,123B1 6,306,728B1  
4,850,072 4,931,844 5,034,796 5,063,307 5,237,481 5,381,025 6,404,065B1 6,162,665 6,534,343

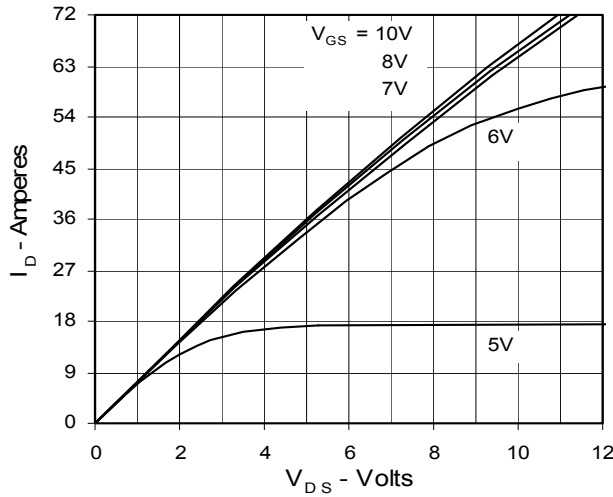
**Fig. 1. Output Characteristics  
@ 25 Deg. C**



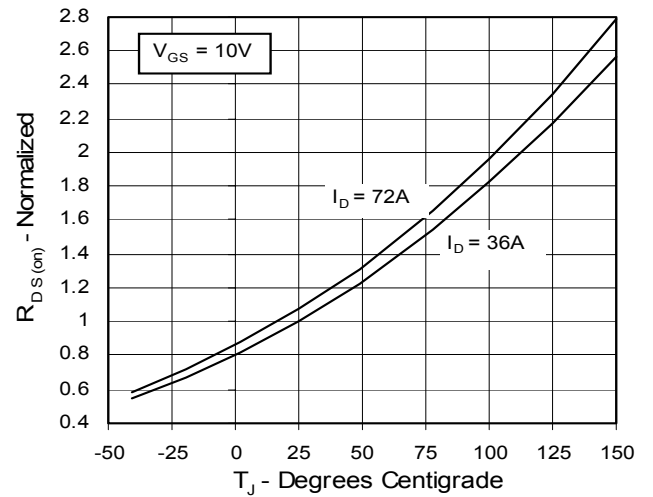
**Fig. 2. Extended Output Characteristics  
@ 25 deg. C**



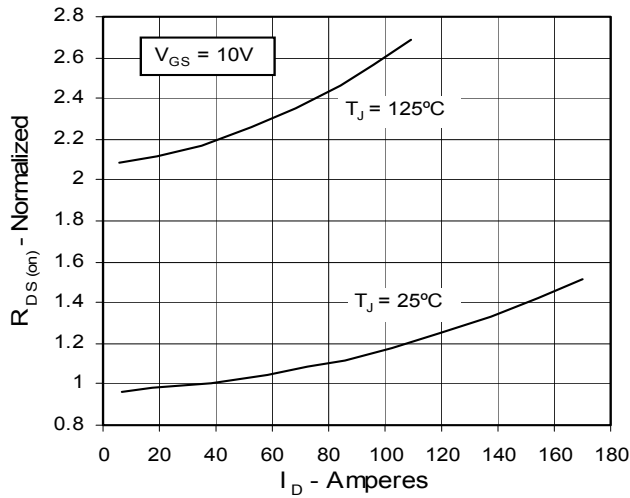
**Fig. 3. Output Characteristics  
@ 125 Deg. C**



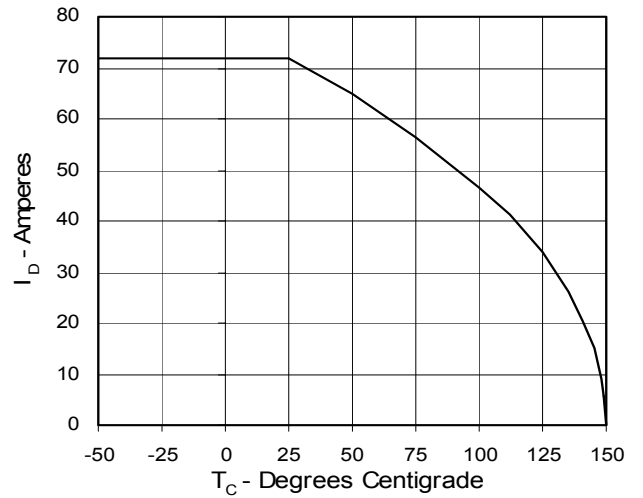
**Fig. 4.  $R_{DS(on)}$  Normalized to  $I_{D25}$  Value vs. Junction Temperature**

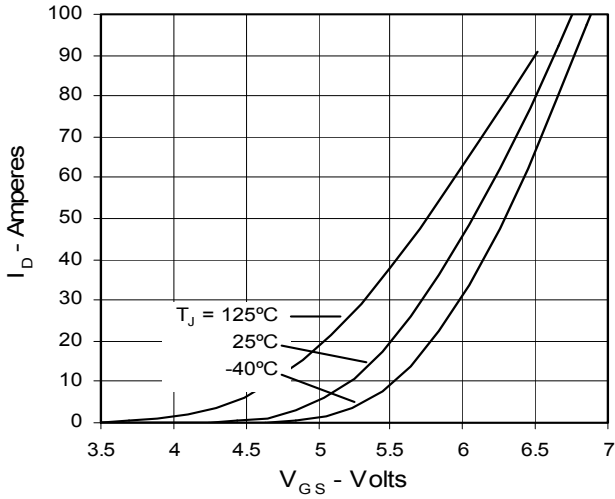
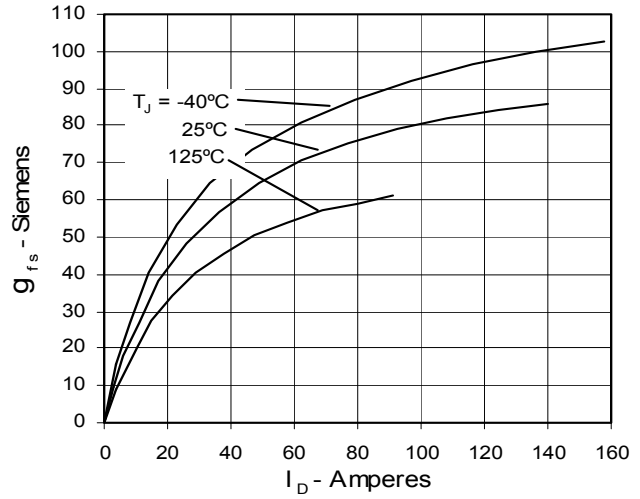
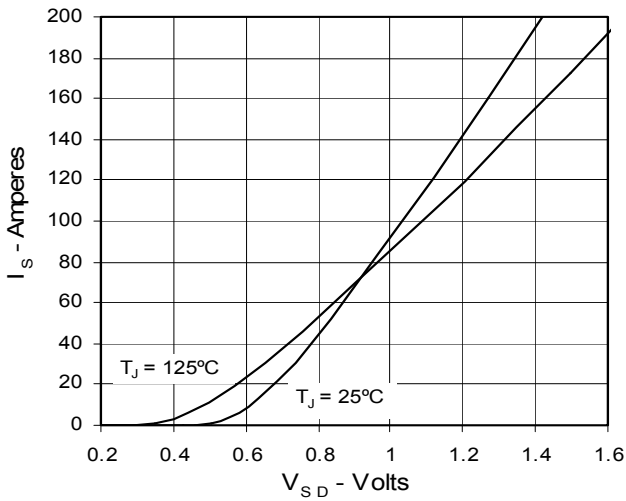
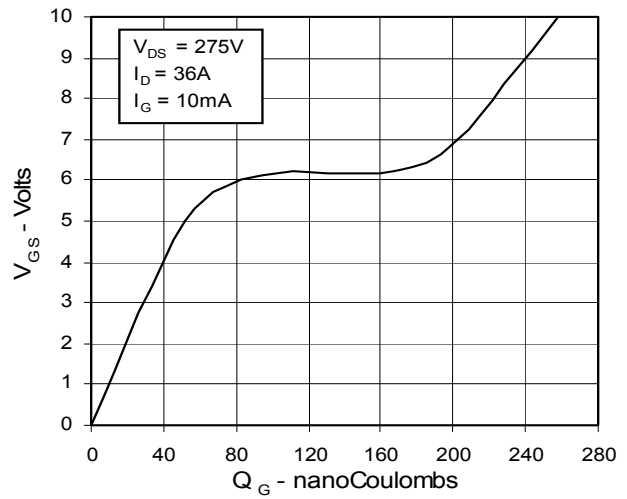
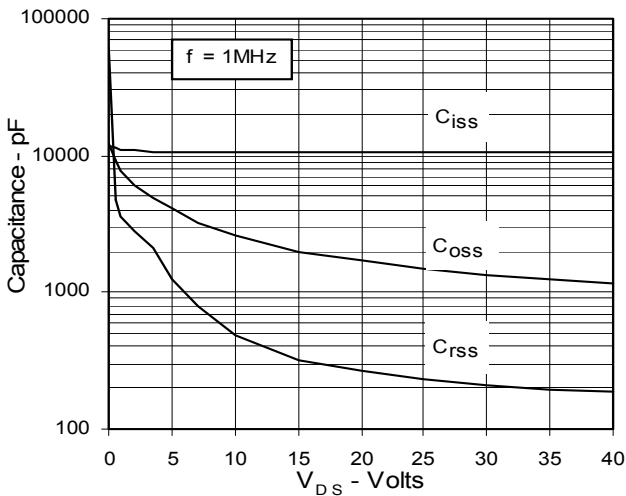
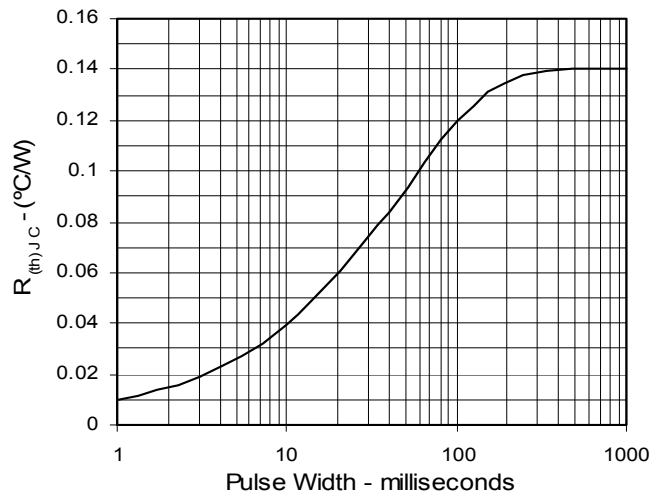


**Fig. 5.  $R_{DS(on)}$  Normalized to  $I_{D25}$  Value vs.  $I_D$**



**Fig. 6. Drain Current vs. Case Temperature**



**Fig. 7. Input Admittance**

**Fig. 8. Transconductance**

**Fig. 9. Source Current vs. Source-To-Drain Voltage**

**Fig. 10. Gate Charge**

**Fig. 11. Capacitance**

**Fig. 12. Maximum Transient Thermal Resistance**


IXYS reserves the right to change limits, test conditions, and dimensions.

 IXYS MOSFETs and IGBTs are covered by one or more of the following U.S. patents:
 

4,835,592	4,881,106	5,017,508	5,049,961	5,187,117	5,486,715	6,306,728B1	6,259,123B1	6,306,728B1
4,850,072	4,931,844	5,034,796	5,063,307	5,237,481	5,381,025	6,404,065B1	6,162,665	6,534,343