

DATA SHEET

SAA4997H V**E**rtical Reconstruction IC (VERIC) for PALplus

Preliminary specification
File under Integrated Circuits, IC02

1996 Oct 24

Vertical Reconstruction IC (VERIC) for PALplus

SAA4997H

FEATURES

- PALplus decoding
- Vertical reconstruction
- Quadrature mirror filter
- Luminance and chrominance processing
- Controlling.

GENERAL DESCRIPTION

The VERTICAL Reconstruction IC (VERIC) for PALplus (VERIC) is especially designed for use in conjunction with the Motion Adaptive Colour Plus And Control IC (MACPACIC) to decode the transmitted PALplus video signal in PALplus colour TV receivers. It provides the full vertical resolution of a PALplus picture from the letter box part and the decoded helper information.

QUICK REFERENCE DATA

SYMBOL	PARAMETER	MIN.	MAX.	UNIT
V _{DD}	supply voltage	–	5.25	V
T _{amb}	operating ambient temperature	0	70	°C

ORDERING INFORMATION

TYPE NUMBER	PACKAGE		
	NAME	DESCRIPTION	VERSION
SAA4997H	QFP64	plastic quad flat package; 64 leads (lead length 1.95 mm); body 14 × 20 × 2.8 mm	SOT319-2

Vertical Reconstruction IC (VERIC) for PALplus

SAA4997H

BLOCK DIAGRAMS

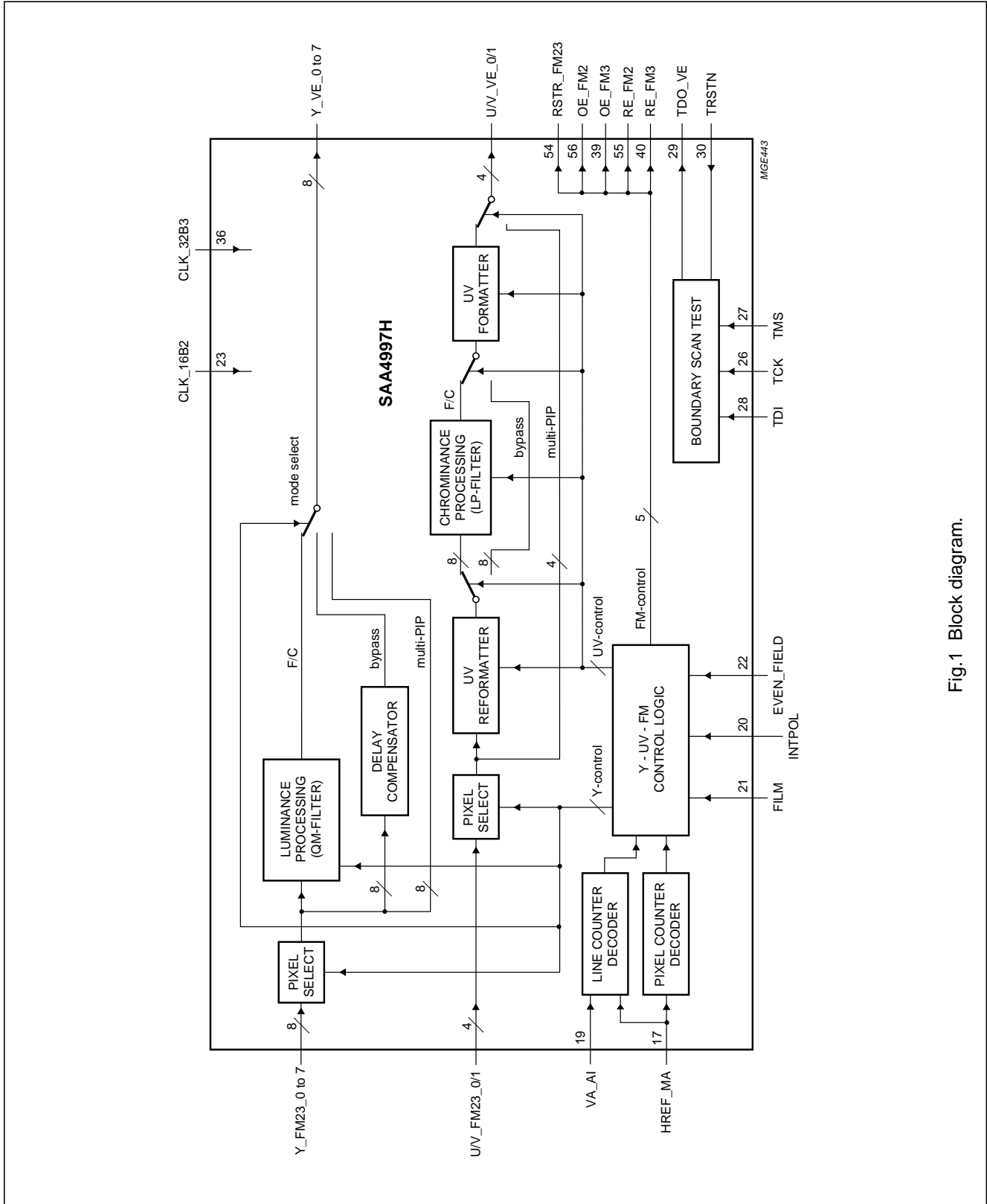
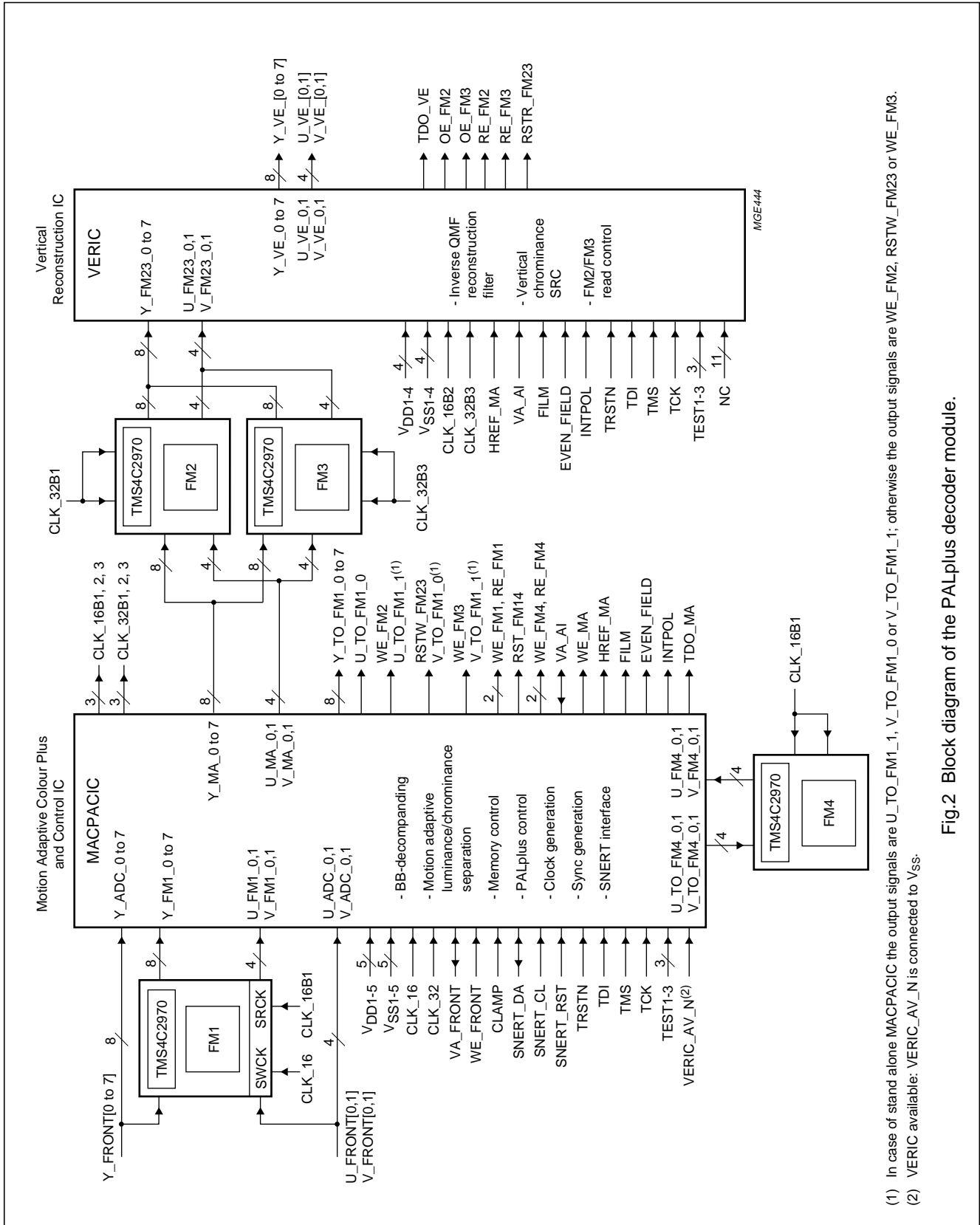

Fig.1 Block diagram.

Vertical Reconstruction IC (VERIC) for PALplus

SAA4997H



(1) In case of stand alone MACPACIC the output signals are U_TO_FM1_1, V_TO_FM1_0 or V_TO_FM1_1; otherwise the output signals are WE_FM2, RSTW_FM23 or WE_FM3.
 (2) VERIC available: VERIC_AV_N is connected to V_{SS}.

Fig.2 Block diagram of the PALplus decoder module.

Vertical Reconstruction IC (VERIC) for PALplus

SAA4997H

PINNING

SYMBOL	PIN	TYPE	DESCRIPTION
Y_VE_1	1	output	luminance output data bit 1
Y_VE_0	2	output	luminance output data bit 0
U_VE_1	3	output	chrominance output data bit 1 U-component
U_VE_0	4	output	chrominance output data bit 0 U-component
V_VE_1	5	output	chrominance output data bit 1 V-component
V_VE_0	6	output	chrominance output data bit 0 V-component
V _{SS1}	7	input	ground 1
V _{DD1}	8	input	positive supply voltage 1 (+5 V)
n.c.	9	–	not connected
n.c.	10	–	not connected
n.c.	11	–	not connected
n.c.	12	–	not connected
n.c.	13	–	not connected
n.c.	14	–	not connected
n.c.	15	–	not connected
n.c.	16	–	not connected
HREF_MA	17	input	horizontal reference
n.c.	18	–	not connected
VA_AI	19	input	vertical reference pulse related to output data
INTPOL	20	input	INTPOL = 1: PALplus interpolation active INTPOL = 0: VERIC switched to bypass mode (standard signal)
FILM	21	input	FILM = 0: CAMERA mode FILM = 1: FILM mode
EVEN_FIELD	22	input	EVEN_FIELD = 0: odd field related to MACPACIC input data EVEN_FIELD = 1: even field related to MACPACIC input data
CLK_16B2	23	input	buffered clock input (16 MHz)
V _{SS2}	24	input	ground 2
V _{DD2}	25	input	positive supply voltage 2 (+5 V)
TCK	26	input	boundary scan test clock input
TMS	27	input	boundary scan test mode select input
TDI	28	input	boundary scan test data input
TDO_VE	29	output	boundary scan test data output
TRSTN	30	input	boundary scan test reset input
n.c.	31	–	not connected
n.c.	32	–	not connected
TEST1	33	tbf	test pins
TEST2	34	tbf	
TEST3	35	tbf	
CLK_32B3	36	input	buffered clock input (32 MHz)
V _{SS3}	37	input	ground 3

Vertical Reconstruction IC (VERIC) for PALplus

SAA4997H

SYMBOL	PIN	TYPE	DESCRIPTION
V _{DD3}	38	input	positive supply voltage 3 (+5 V)
OE_FM3	39	output	output enable field memory 3
RE_FM3	40	output	read enable field memory 3
V_FM23_1	41	input	chrominance input data bit 1 V-component
V_FM23_0	42	input	chrominance input data bit 0 V-component
U_FM23_1	43	input	chrominance input data bit 1 U-component
U_FM23_0	44	input	chrominance input data bit 0 U-component
Y_FM23_7	45	input	Y input data bit 7
Y_FM23_6	46	input	Y input data bit 6
Y_FM23_5	47	input	Y input data bit 5
Y_FM23_4	48	input	Y input data bit 4
Y_FM23_3	49	input	Y input data bit 3
n.c.	50	–	not connected
Y_FM23_2	51	input	Y input data bit 2
Y_FM23_1	52	input	Y input data bit 1
Y_FM23_0	53	input	Y input data bit 0
RSTR_FM23	54	output	reset read field memory 2 and 3
RE_FM2	55	output	read enable field memory 2
OE_FM2	56	output	output enable field memory 2
V _{DD4}	57	input	positive supply voltage 4 (+5 V)
V _{SS4}	58	input	ground 4
Y_VE_7	59	output	luminance output data bit 7
Y_VE_6	60	output	luminance output data bit 6
Y_VE_5	61	output	luminance output data bit 5
Y_VE_4	62	output	luminance output data bit 4
Y_VE_3	63	output	luminance output data bit 3
Y_VE_2	64	output	luminance output data bit 2

Vertical Reconstruction IC (VERIC) for PALplus

SAA4997H

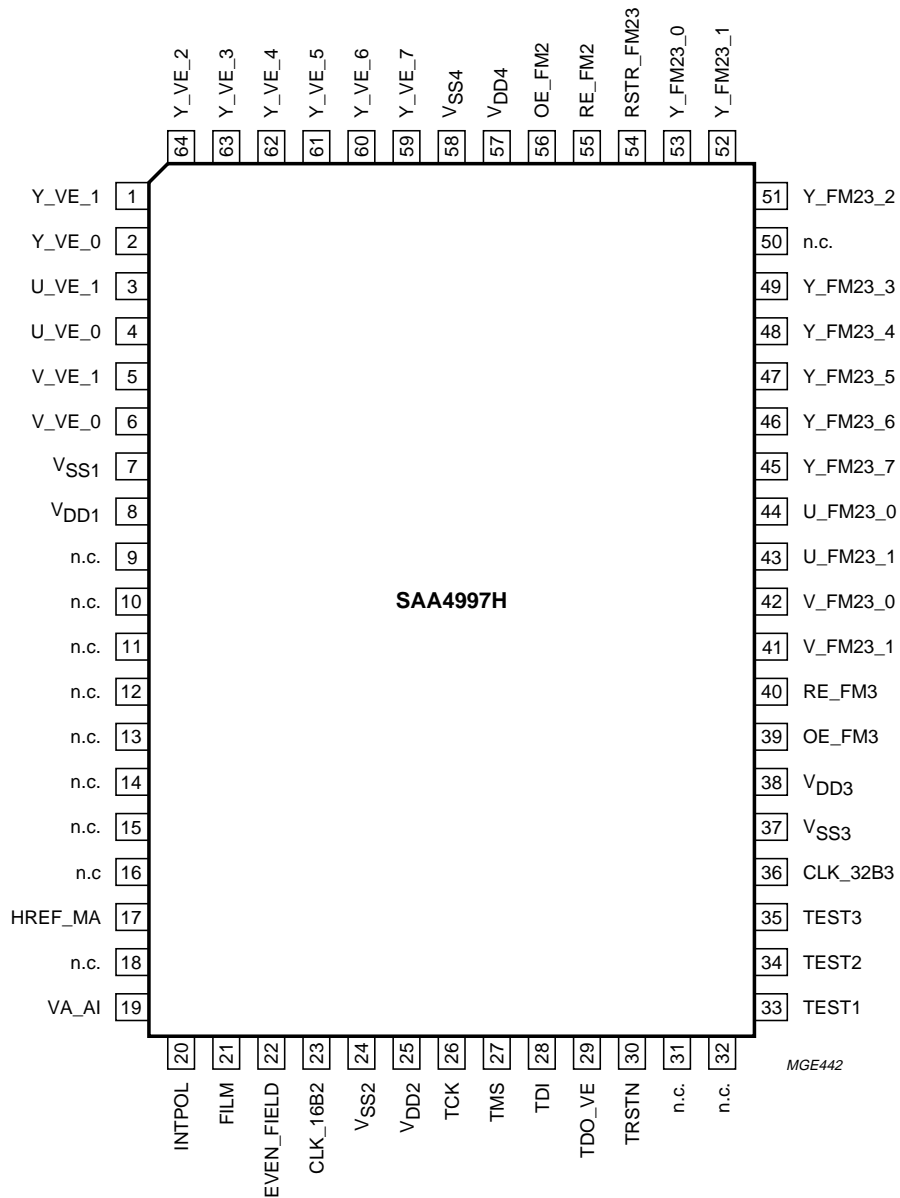

Fig.3 Pin configuration.

Vertical Reconstruction IC (VERIC) for PALplus

SAA4997H

FUNCTIONAL DESCRIPTION

Introduction

As shown in Fig.2 the PALplus module consists of two special integrated circuits:

- Motion Adaptive Colour Plus And Control IC (MACPACIC)
- Vertical Reconstruction IC (VERIC)

and four field memories TMS4C2970.

The MACPACIC and the VERIC are intended to generate digitally decoded 50 Hz YUV signals. The MACPACIC performs the decompanding function for the helper lines and the motion adaptive luminance/chrominance separation. Furthermore, PALplus system controlling, memory controlling and clock generation are carried out in this circuit.

The function of the VERIC is to reconstruct the separated 2×72 helper lines and the 430 main lines into a standard 576 lines frame according the PALplus system description "REV 2.0". Chrominance is converted from 430 lines to 576 lines using a vertical sample rate converter.

The data of the VERIC are clocked out with 16 MHz. The Y : U : V bandwidth ratio is 4 : 1 : 1.

The functional block diagram of the VERIC is shown in Fig.1. The device consists of 3 main parts:

- Luminance processing
- Chrominance processing
- Controlling.

The input data are delivered by the field memories FM2 and FM3, which include multiplexed first and second field data processed by the MACPACIC. The luminance and chrominance input data of the VERIC are clocked with 32 MHz (CLK_32B3). Internally the device operates at 32 or 16 MHz clock frequency.

Luminance processing

In the PALplus encoder the luminance signal is separated vertically into two sub-bands by a special Quadrature Mirror Filter (QMF).

A vertical low-pass sub-band consists of the 430 main letter box lines per frame, and a vertical high-pass sub-band includes the 144 helper lines per frame.

The used QMF technique has two advantages:

- Essentially loss-free data processing
- Cancellation of alias components in the main and helper signal in the decoder.

The luminance vertical conversion process in the decoder is complementary to that of the encoder.

In the decoder the inverse QMF function is implemented to recombine the two separated sub-bands and to generate the original video signal with 576 active lines per frame.

Each output line is calculated from up to seven input lines stored in line memories containing main or helper information. The various lines are multiplied by switched coefficients, changing every line within a sequence of four lines, depending on the specific mode (CAMERA or FILM).

In case of standard PAL reception, the VERIC is switched to bypass mode controlled by the signal INTPOL.

For multi-PIP processing the VERIC is also switched to bypass mode, but controlling of FM2/3 is different (see Fig.6). The total signal delay between the MACPACIC input and the VERIC output is one line for this mode. FM2/3 are driven with 32 MHz clock frequency.

The non-multiplexed input data are clocked out with 16 MHz.

Chrominance processing

The chrominance processing is carried out by the vertical interpolation filter (poly phase filter).

In CAMERA and FILM mode, intra-field vertical sample rate conversion is carried out.

One output line is calculated out of three or four lines in CAMERA or FILM mode using different coefficients or passed through in bypass mode.

Control functions

The VERIC controller generates the necessary internal control signals for the line memories, formatters, reformatters, the selector signals for the multiplexers and the read signals for the field memories FM2/3.

The system control input signals EVEN_FIELD, INTPOL and FILM are derived from the control part of the MACPACIC. The field selection information EVEN_FIELD is related to the input data of the MACPACIC and is adapted in the VERIC to its input data.

The control functions are described in Tables 1 and 2.

Table 1 EVEN_FIELD

VALUE	STATUS
EVEN_FIELD = 1	even field selected
EVEN_FIELD = 0	odd field selected

Vertical Reconstruction IC (VERIC) for PALplus

SAA4997H

Table 2 INTPOL and FILM

VALUE		STATUS
INTPOL = 0	FILM = 0	bypass mode; standard signals
INTPOL = 1	FILM = 0	interpolation active; PALplus CAMERA mode
INTPOL = 0	FILM = 1	bypass mode; multi-PIP
INTPOL = 1	FILM = 1	interpolation active; PALplus FILM mode

Modes and delays

The PALplus module can operate in two different hardware configurations:

- Full PALplus configuration (MACPACIC and VERIC)
- Stand alone MACPACIC.

The vertical interpolation of the VERIC can be activated by the signal INTPOL depending on the PALplus signalling bits, transmitted in line 23 indicating the type of signal being received.

However, the delay between input data of the MACPACIC and output data of the VERIC always has to be 1.5 fields. This is achieved with a suitable read timing of the field memories FM2 and FM3 controlled by VA_AI which is derived from the field length measurement in the MACPACIC.

In case of INTPOL = LOW and additionally FILM = HIGH (FILM mode), the VERIC is switched to multi-PIP mode. In case the delay between input of the MACPACIC and output of the VERIC is one line (1024 CLK_16 periods).

The line and pixel timings of the VERIC are shown in Figures 5 to 14.

Table 3 Delays

MODE	FIELD	VERIC I/O DELAY
FILM mode	first	2 lines
	second	3 lines
CAMERA mode	first	3 lines
	second	4 lines

Input/Output formats

INPUT FORMATS

The luminance input range of the main and helper signal has the following values:

- Main signal: black = 16, white = 191 (straight binary)
- Helper signal: ± 70 , mid = 128 (straight binary)
- Chrominance format: ± 90 , mid = 0 (two's complement).

OUTPUT FORMATS

- Luminance format: black = 16, white = 191 (straight binary)
- Blanking: code 16
- Chrominance format: ± 90 , mid = 0 (two's complement)
- Blanking: code 0.

Test activities

The pins TEST1, TEST2 and TEST3 are provided to perform the IC test activities, such as scan test.

The pins TRSTN, TDI, TMS, TCK and TDO_VE are intended for a boundary scan test.

Vertical Reconstruction IC (VERIC) for PALplus

SAA4997H

DC CHARACTERISTICS

T_j = 0 to 125 °C

SYMBOL	PARAMETER	CONDITIONS	MIN.	TYP.	MAX.	UNIT
Supply						
V _{DD}	supply voltage		4.75	5.0	5.25	V
I _{DD}	supply current	V _{DD} = 5 V	–	–	80	mA
I _{DD(q)}	quiescent supply current	all inputs to V _{DD} or V _{SS}	–	–	100	μA
Inputs						
V _{IL}	LOW level input voltage		–0.5	–	+0.8	V
V _{IH}	HIGH level input voltage		2.0	–	V _{DD}	V
I _{LI}	input leakage current		–	–	1.0	μA
Outputs						
V _{OL}	LOW level output voltage	I _O = 20 μA	–	–	0.1	V
V _{OH}	HIGH level output voltage	I _O = 20 μA	V _{DD} – 0.1	–	–	V
I _{OL}	LOW level output current	V _O = 0.5 V	4.0	–	–	mA
I _{OH}	HIGH level output current	V _O = V _{DD} – 0.5 V	4.0	–	–	mA

AC CHARACTERISTICS

T_j = 0 to 125 °C

SYMBOL	PARAMETER	CONDITIONS	MIN.	TYP.	MAX.	UNIT
Clock timing CLK_32B3 (see Fig.4)						
T _{CY(32)}	cycle time		28.1	31.25	–	ns
t _H	HIGH time		9.2	–	–	ns
t _L	LOW time		9.2	–	–	ns
t _r	rise time		2.0	–	4.0	ns
t _f	fall time		2.0	–	4.0	ns
Δf _{clk}	deviation of clock frequency		–10	–	+10	%
Clock timing CLK_16B2 (see Fig.4)						
T _{CY(16)}	cycle time		56.2	–	–	ns
t _H	HIGH time		20.5	–	–	ns
t _L	LOW time		20.5	–	–	ns
t _r	rise time		2.0	–	4.0	ns
t _f	fall time		4.0	–	4.0	ns
δ	duty cycle	$\delta = \frac{t_H}{t_L}$	40	–	50	%

Vertical Reconstruction IC (VERIC) for PALplus

SAA4997H

SYMBOL	PARAMETER	CONDITIONS	MIN.	TYP.	MAX.	UNIT
Input data timing (CLK_32)						
t_{su}	input data set-up time					
	CLK_16B2		-4.7	-	-	ns
	Y and UV_FM23		-0.8	-	-	ns
$t_{h(i)}$	input data hold time					
	CLK_16B2		5.1	-	-	ns
	Y and UV_FM23		5.2	-	-	ns
Input control timing (CLK_16B2)						
HREF_MA, VA_AI, FILM, EVEN_FIELD AND INTPOL						
t_{su}	input data set-up time		4.5	-	-	ns
$t_{h(i)}$	input data hold time		0.1	-	-	ns
Output data timing (CLK_16B2)						
Y AND UV_FM23						
$t_{h(o)}$	output data hold time	$C_L = 15 \text{ pF}$	8	-	-	ns
$t_{d(o)}$	output data delay time	$C_L = 15 \text{ pF}$	-	-	27	ns
Output control timing (CLK_32B3)						
OE_FM2, OE_FM3, RE_FM2, RE_FM3 AND RSTR_FM23						
$t_{h(o)}$	output data hold time	$C_L = 15 \text{ pF}$	5	-	-	ns
$t_{d(o)}$	output data delay time	$C_L = 15 \text{ pF}$	-	-	20	ns
Delays						
$t_{w(HREF)}$	HREF_MA pulse width		-	$60 \times T_{CY(16)}$	-	ns
$t_{d(RE)}$	delay RE_FM2/3 to HREF_MA		-	$127 \times T_{CY(32)}$	-	ns
$t_{w(RE)}$	RE_FM2/3 pulse width		-	$1680 \times T_{CY(32)}$	-	ns
$t_{d(VE)(MA)}$	delay HREF_MA to YUV_VE		-	$80 \times T_{CY(16)}$	-	ns
$t_{d(VE)}$	delay data input to output		-	$16 \times T_{CY(16)}$	-	ns
$t_{d(VE)}$	delay data input to output	multi-PIP	-	$2 \times T_{CY(16)}$	-	ns
$t_{d(RSTR)}$	delay RSTR	multi-PIP	-	$2016 \times T_{CY(32)}$	-	ns
$t_{d(FM2)}$	delay FM2 input to output	multi-PIP	-	$2040 \times T_{CY(32)}$	-	ns

Vertical Reconstruction IC (VERIC) for PALplus

SAA4997H

TIMING

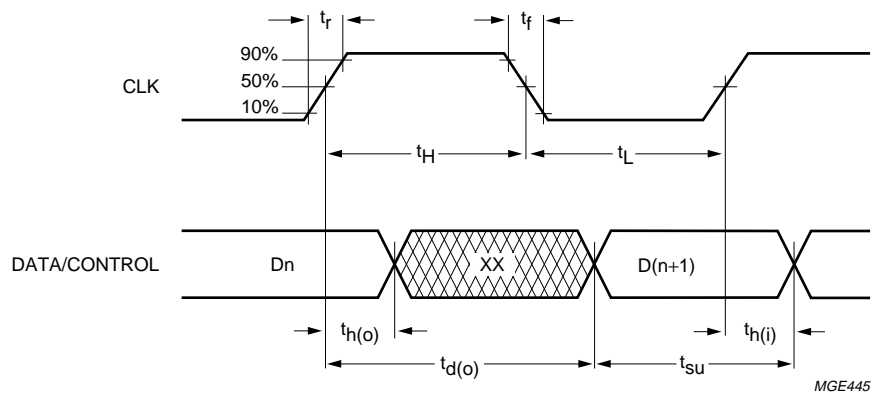

MGE445

Data input: CLK = CLK_32B3
Data output: CLK = CLK_16B2
Control input: CLK = CLK_16B2
Control output: CLK = CLK_32B3

Fig.4 Data/control input/output set-up and hold timing.

Vertical Reconstruction IC (VERIC) for PALplus

SAA4997H

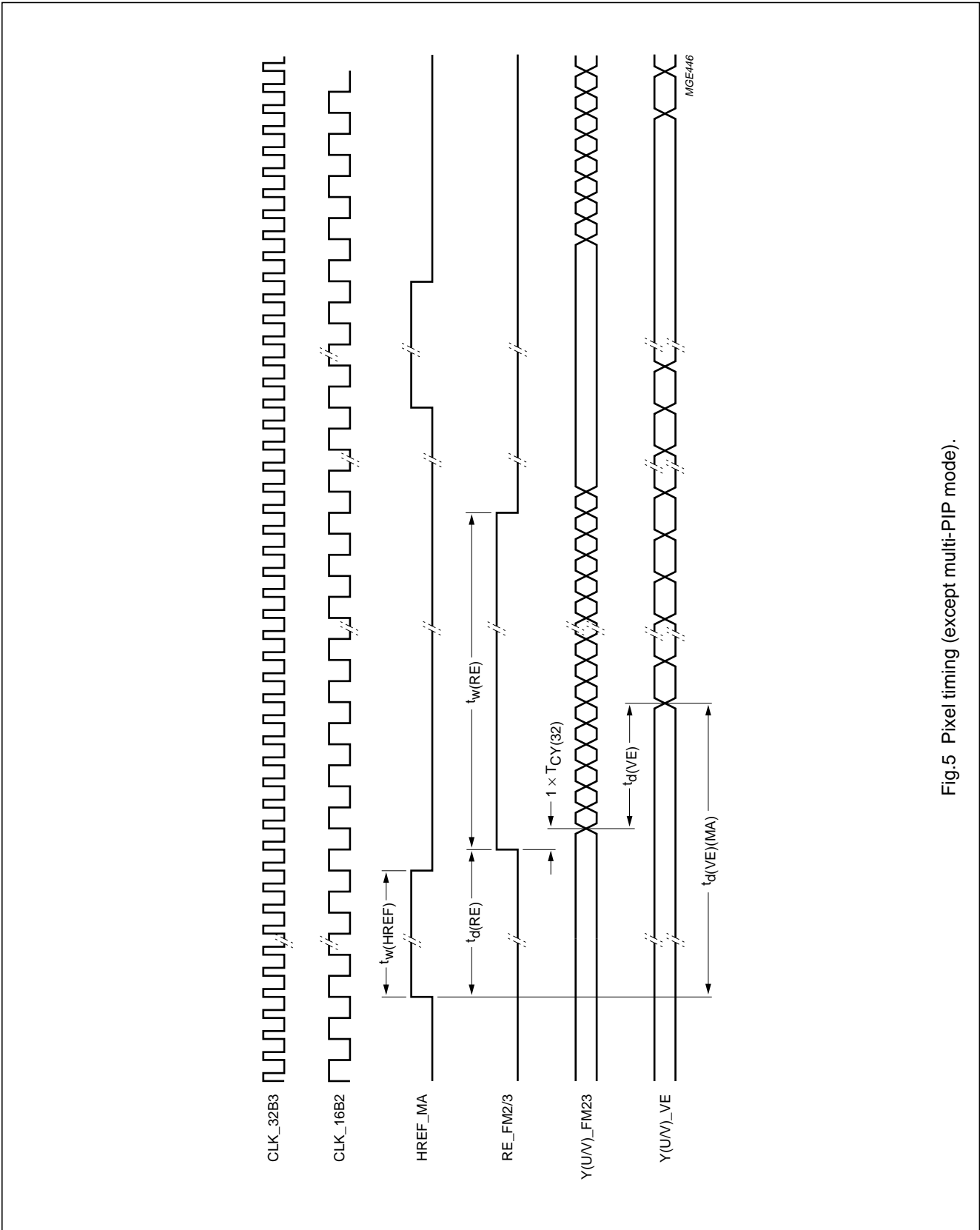

Fig.5 Pixel timing (except multi-PIP mode).

Vertical Reconstruction IC (VERIC) for PALplus

SAA4997H

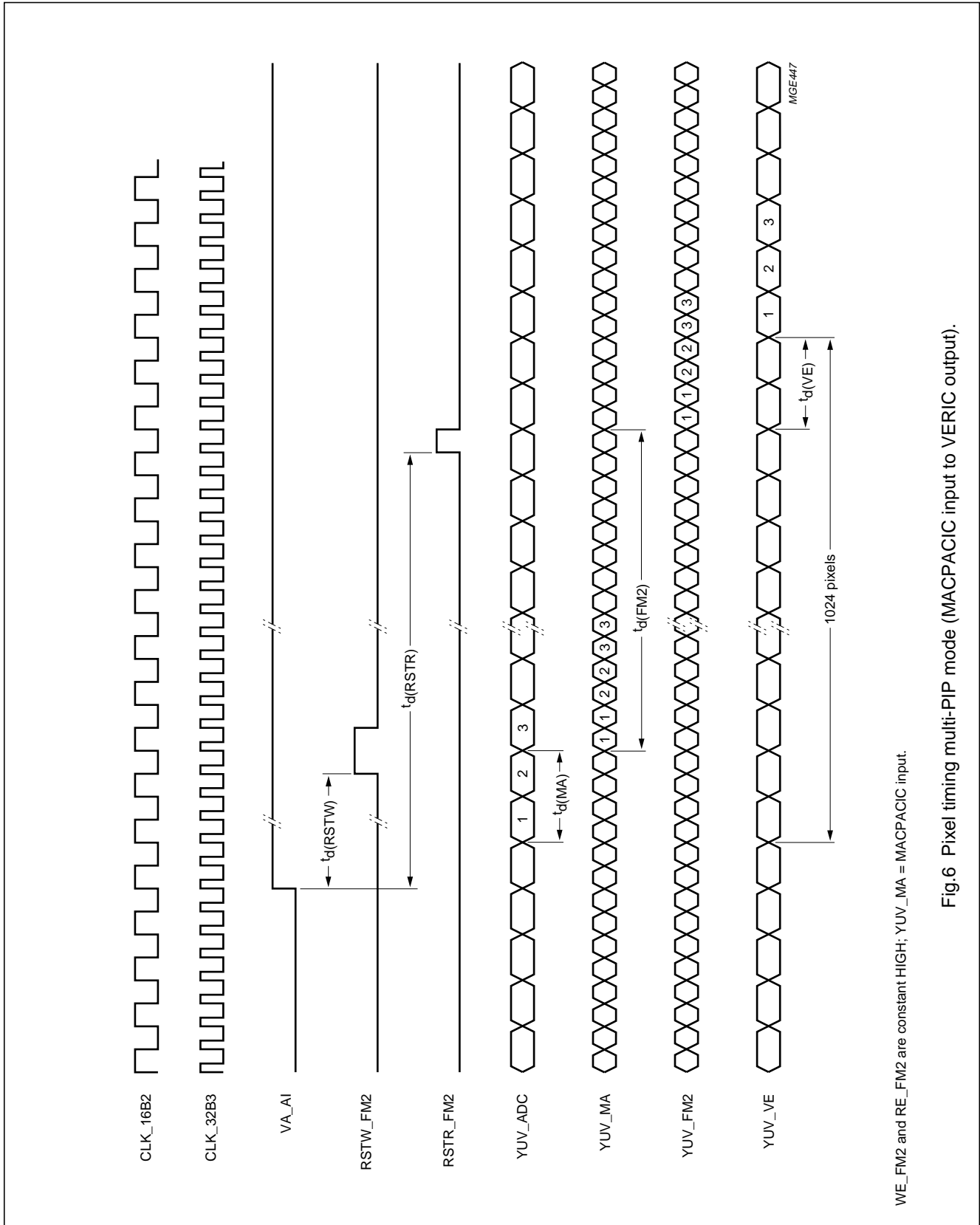

Fig.6 Pixel timing multi-PIP mode (MACPACIC input to VERIC output).

Vertical Reconstruction IC (VERIC) for PALplus

SAA4997H

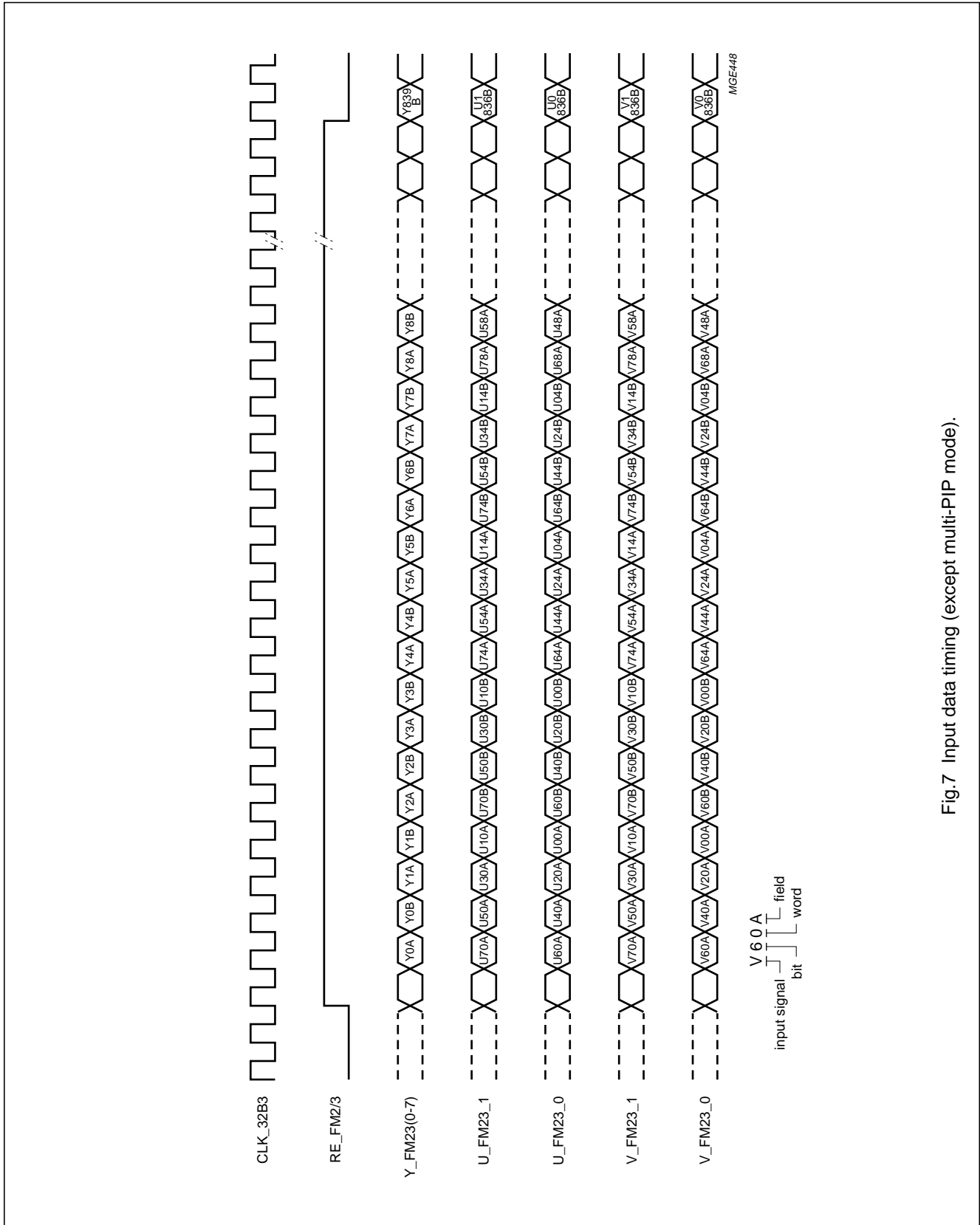

Fig.7 Input data timing (except multi-PIP mode).

Vertical Reconstruction IC (VERIC) for PALplus

SAA4997H

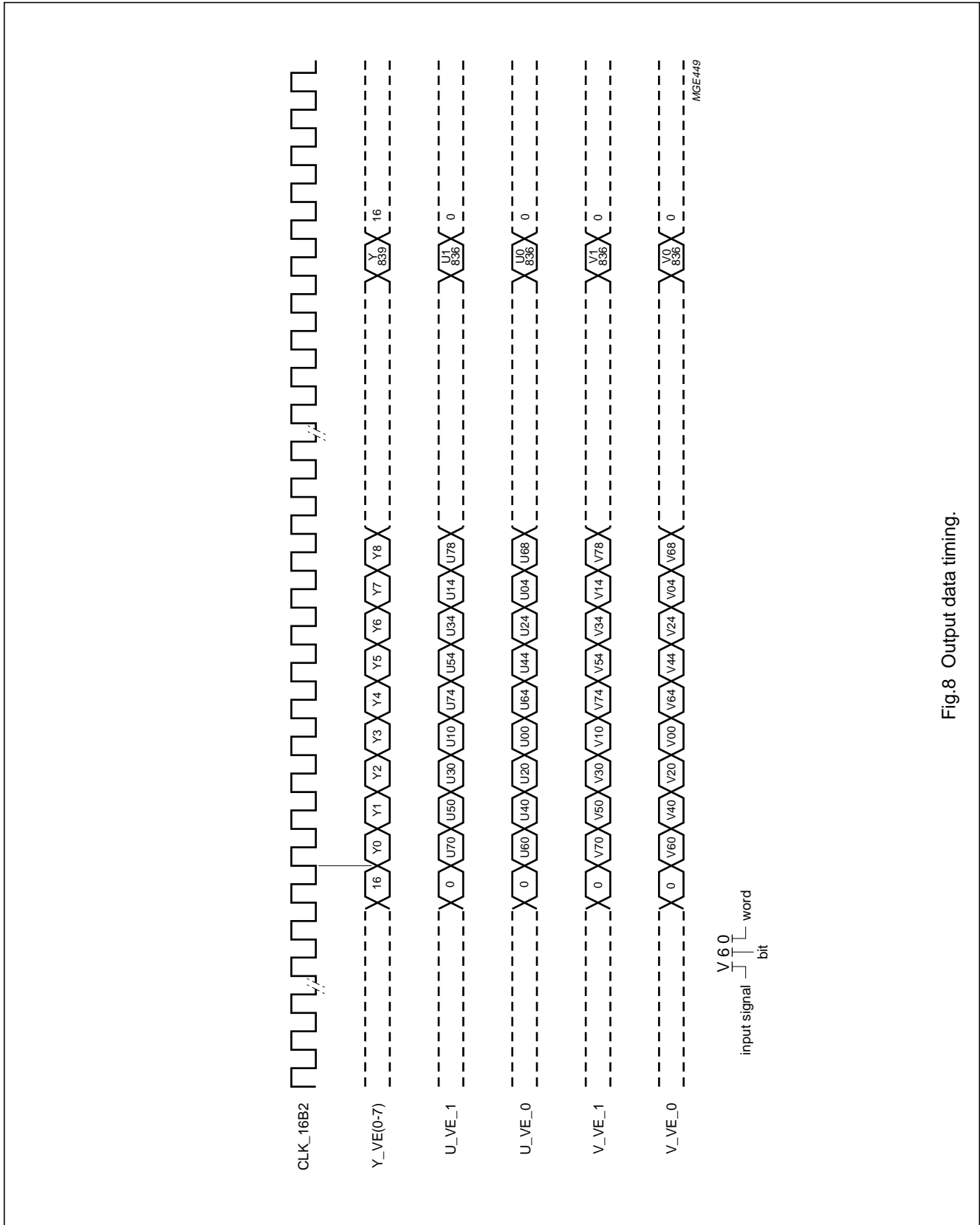

Fig.8 Output data timing.

VERTICAL Reconstruction IC (VERIC) for PALplus

SAA4997H

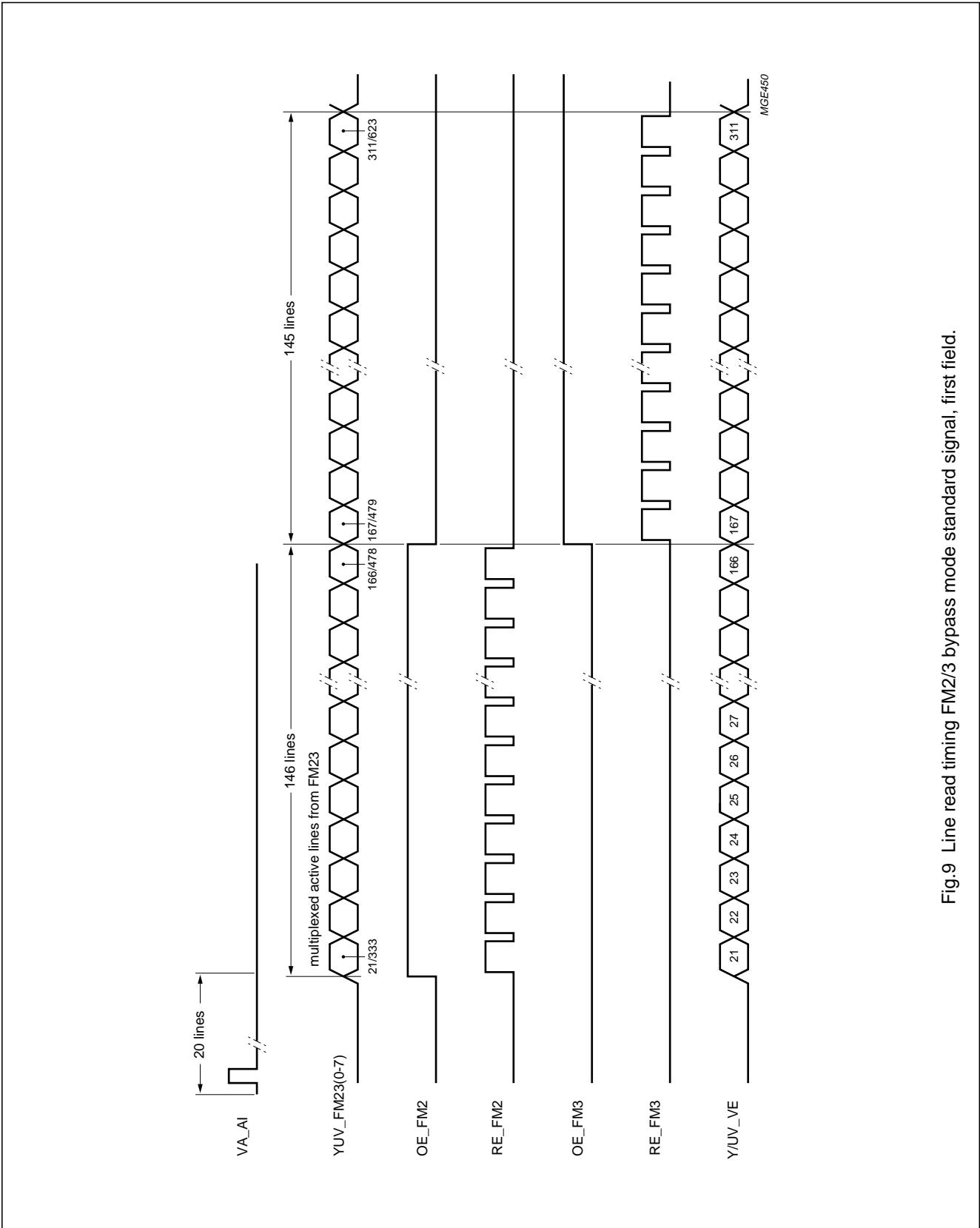

Fig.9 Line read timing FM2/3 bypass mode standard signal, first field.

VERTICAL Reconstruction IC (VERIC) for PALplus

SAA4997H

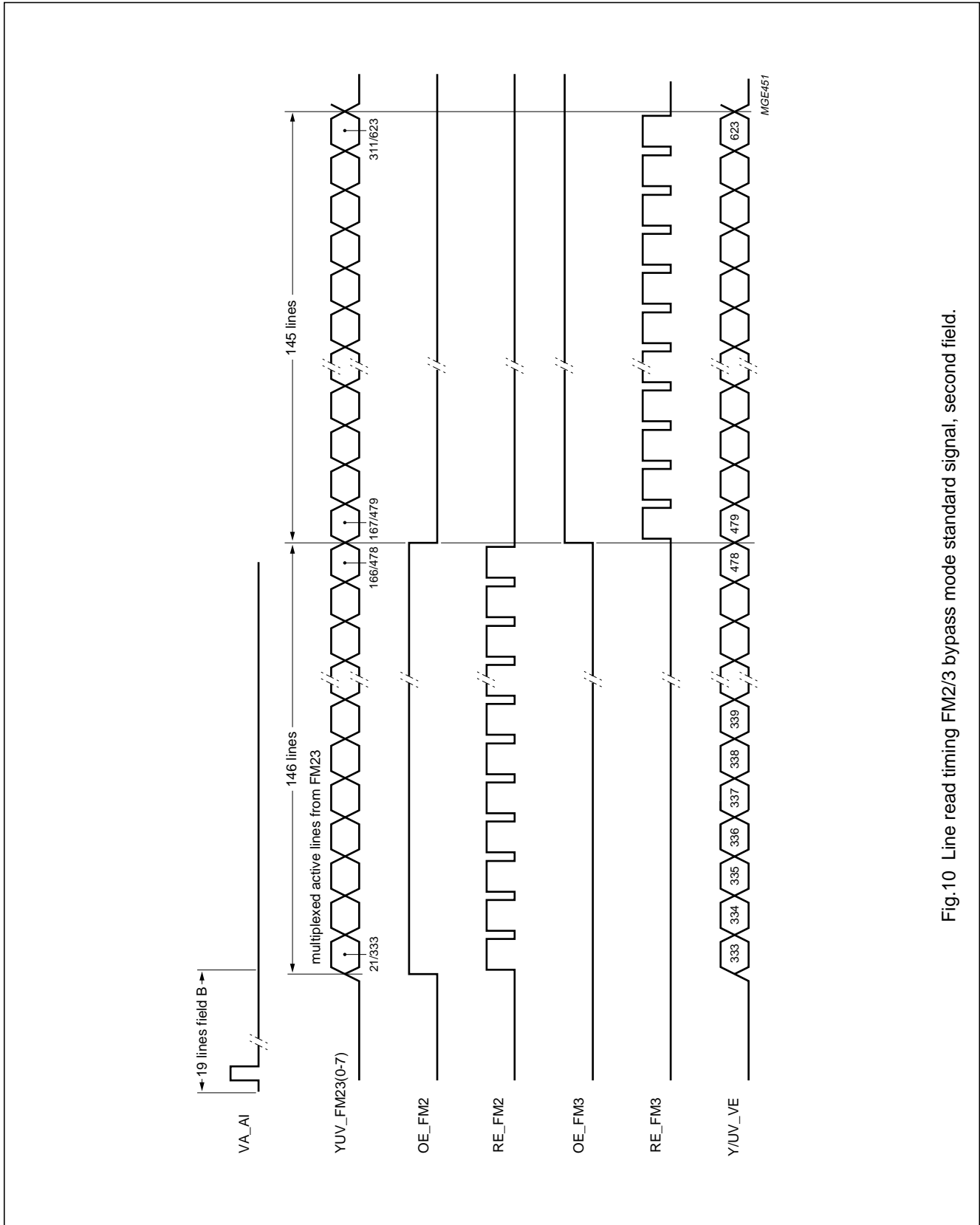
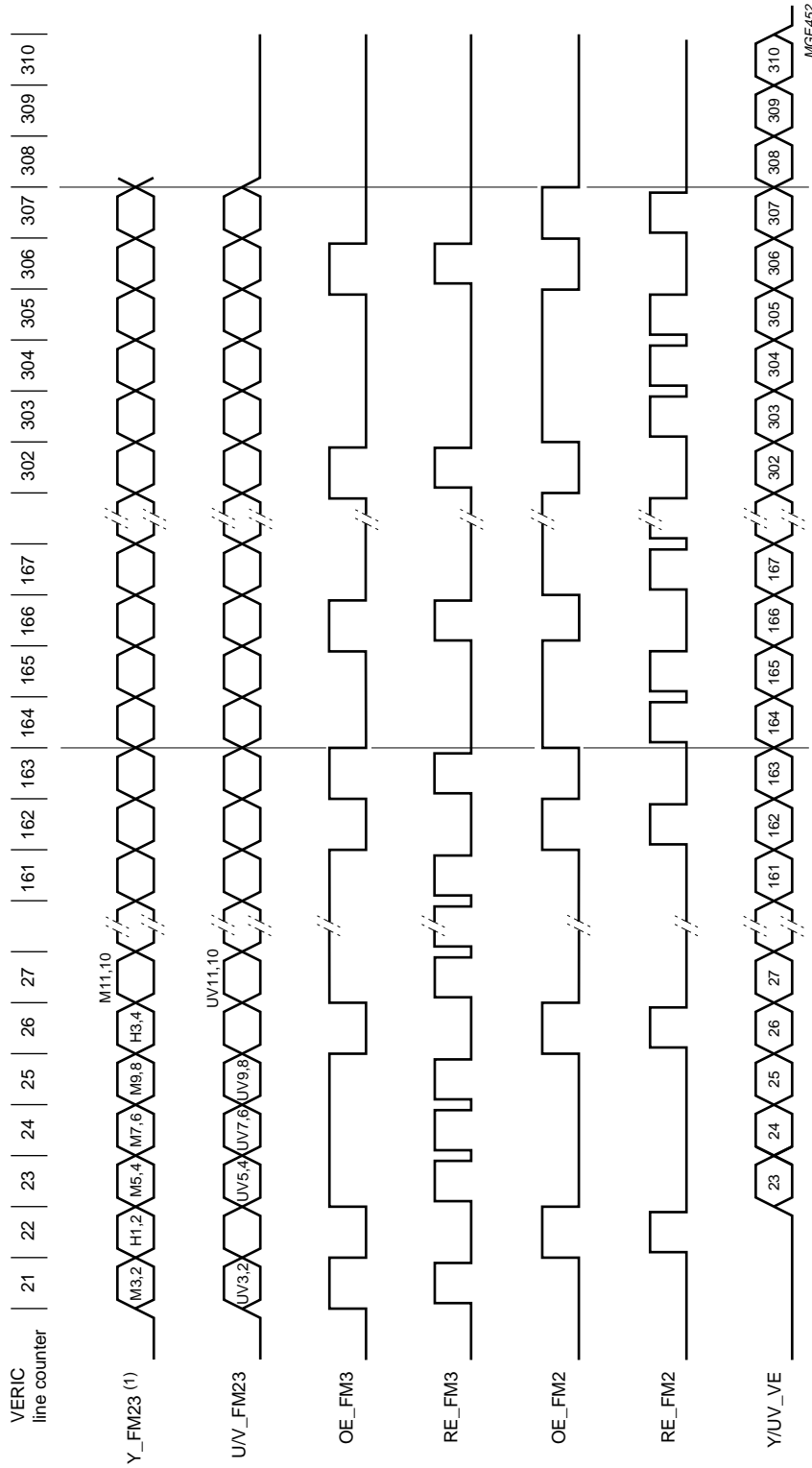

Fig.10 Line read timing FM2/3 bypass mode standard signal, second field.

Vertical Reconstruction IC (VERIC) for PALplus

SAA4997H



(1) M = main line and H = helper line.

Fig.11 Line read timing FM2/3 CAMERA mode, first field.

Vertical Reconstruction IC (VERIC) for PALplus

SAA4997H

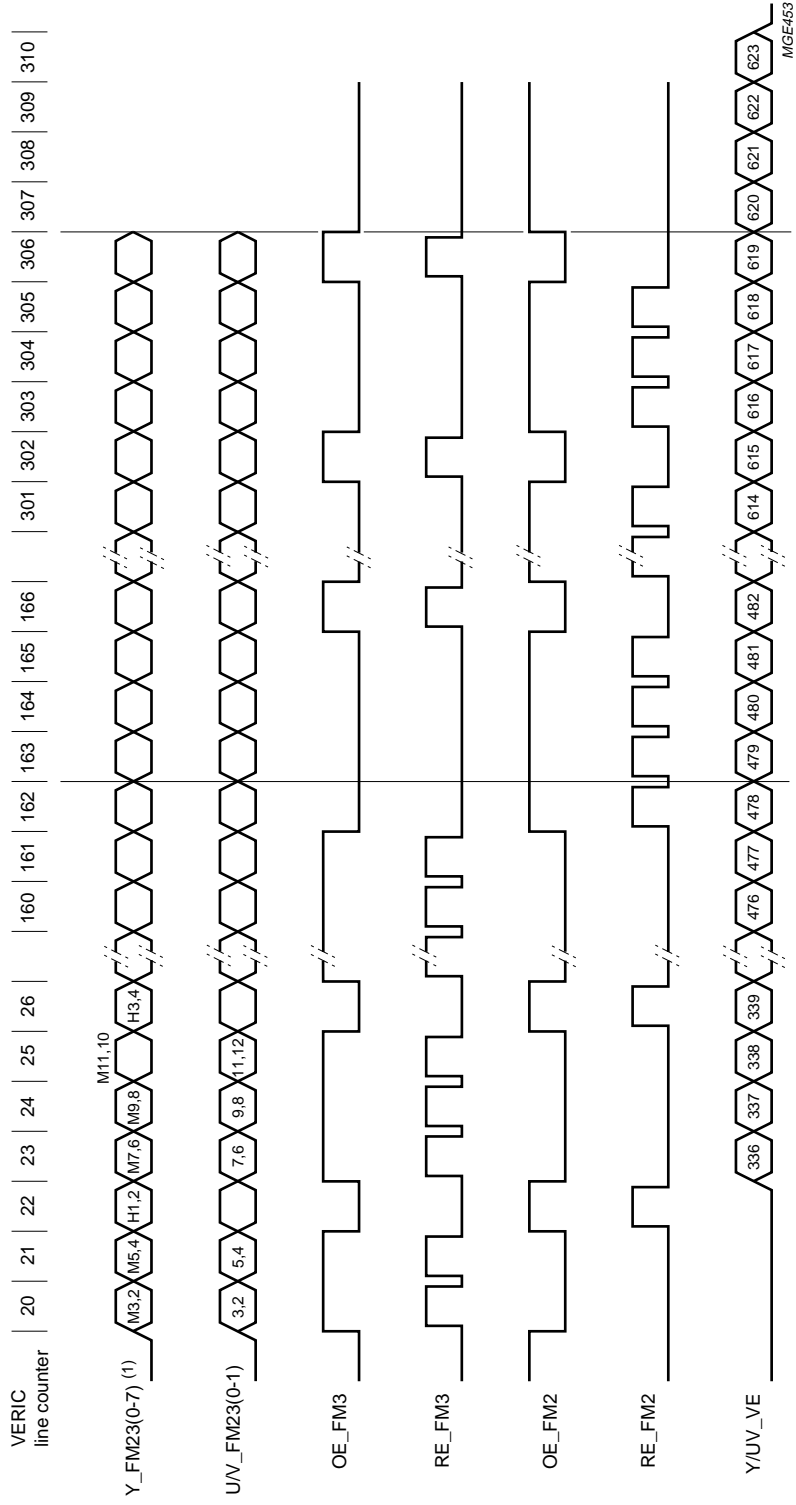

(1) M = main line and H = helper line.

Fig.12 Line read timing FM2/3 CAMERA mode, second field.

Vertical Reconstruction IC (VERIC) for PALplus

SAA4997H

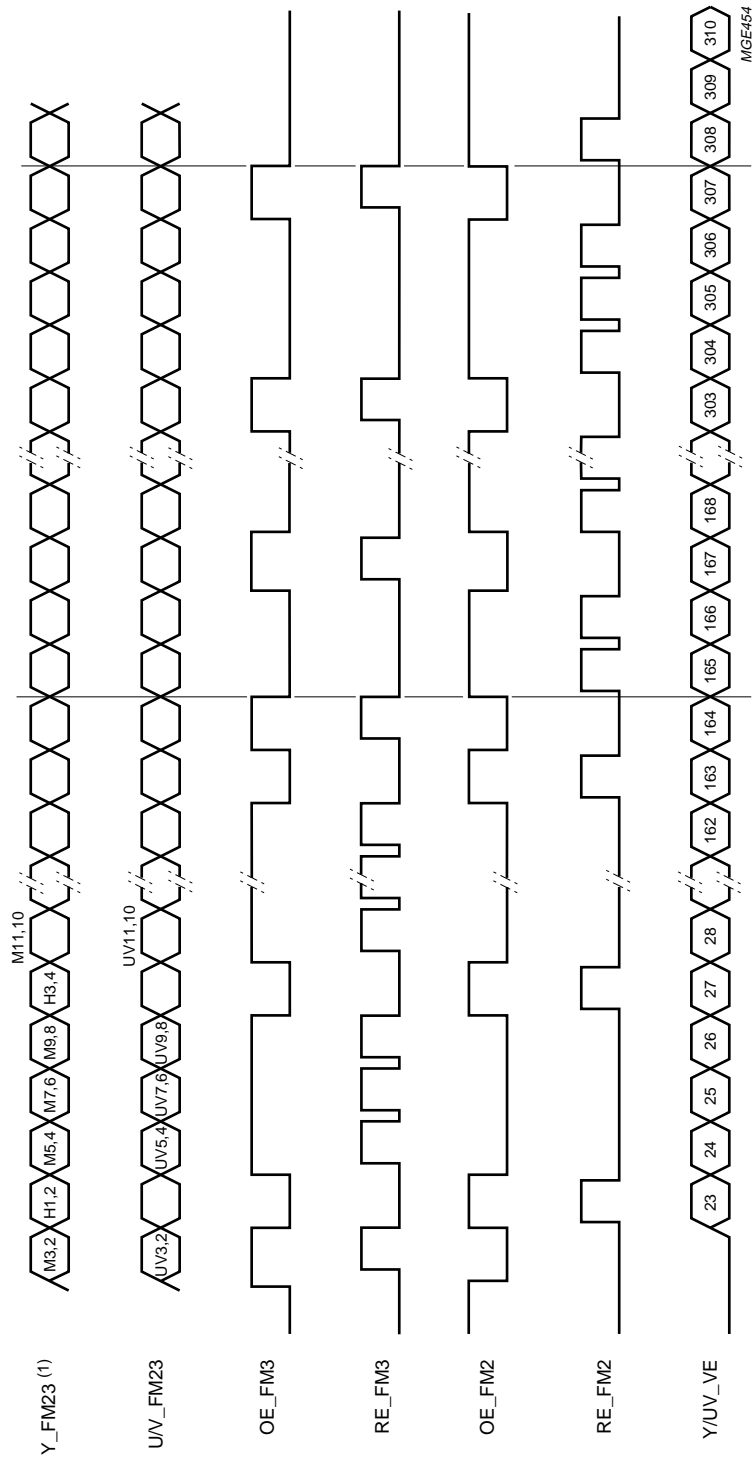

(1) M = main line and H = helper line.

Fig.13 Line read timing FM2/3 FILM mode, first field.

Vertical Reconstruction IC (VERIC) for PALplus

SAA4997H

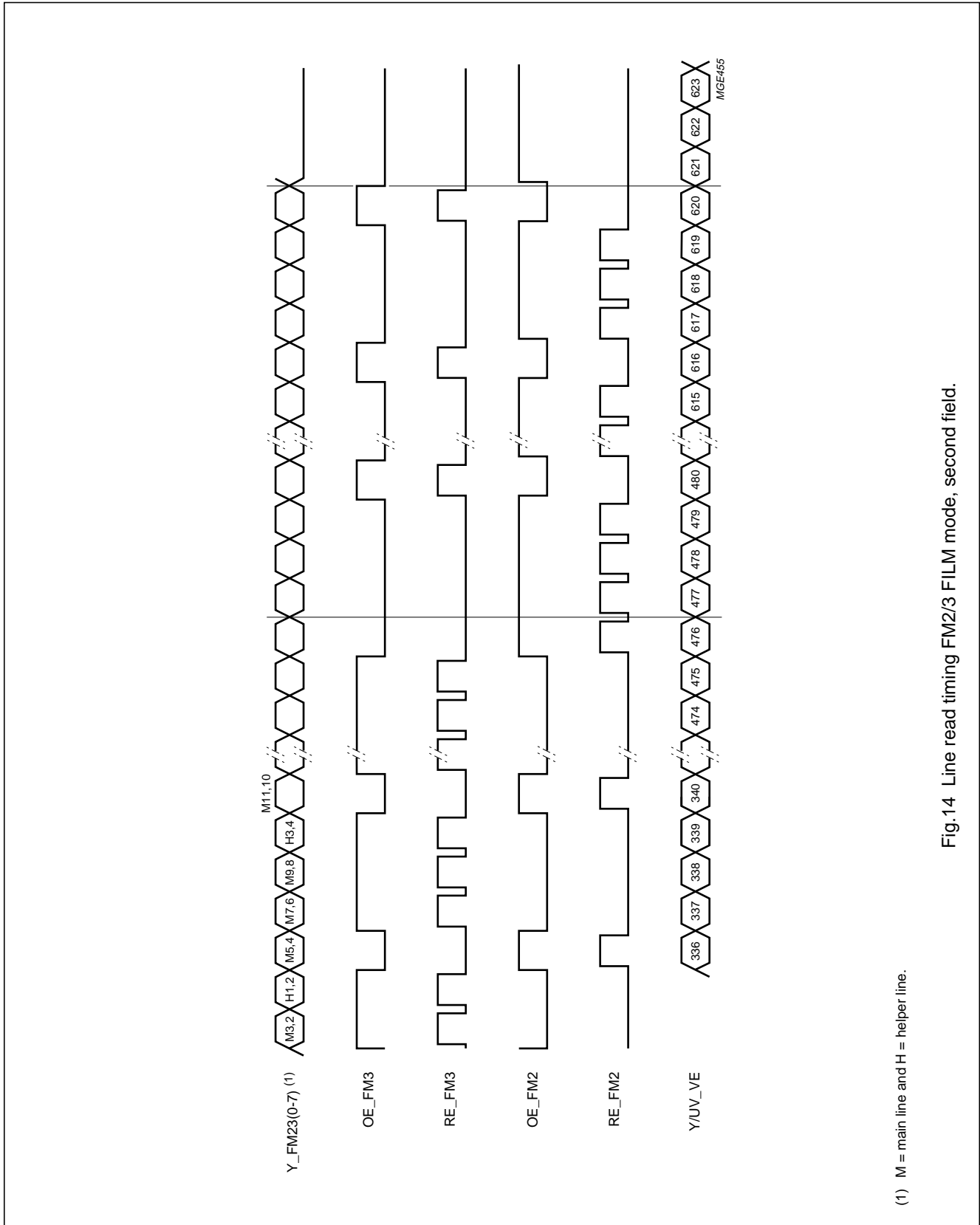

(1) M = main line and H = helper line.

Fig.14 Line read timing FM2/3 FILM mode, second field.

Vertical Reconstruction IC (VERIC) for PALplus

SAA4997H

PACKAGE OUTLINE

QFP64: plastic quad flat package; 64 leads (lead length 1.95 mm); body 14 x 20 x 2.8 mm

SOT319-2

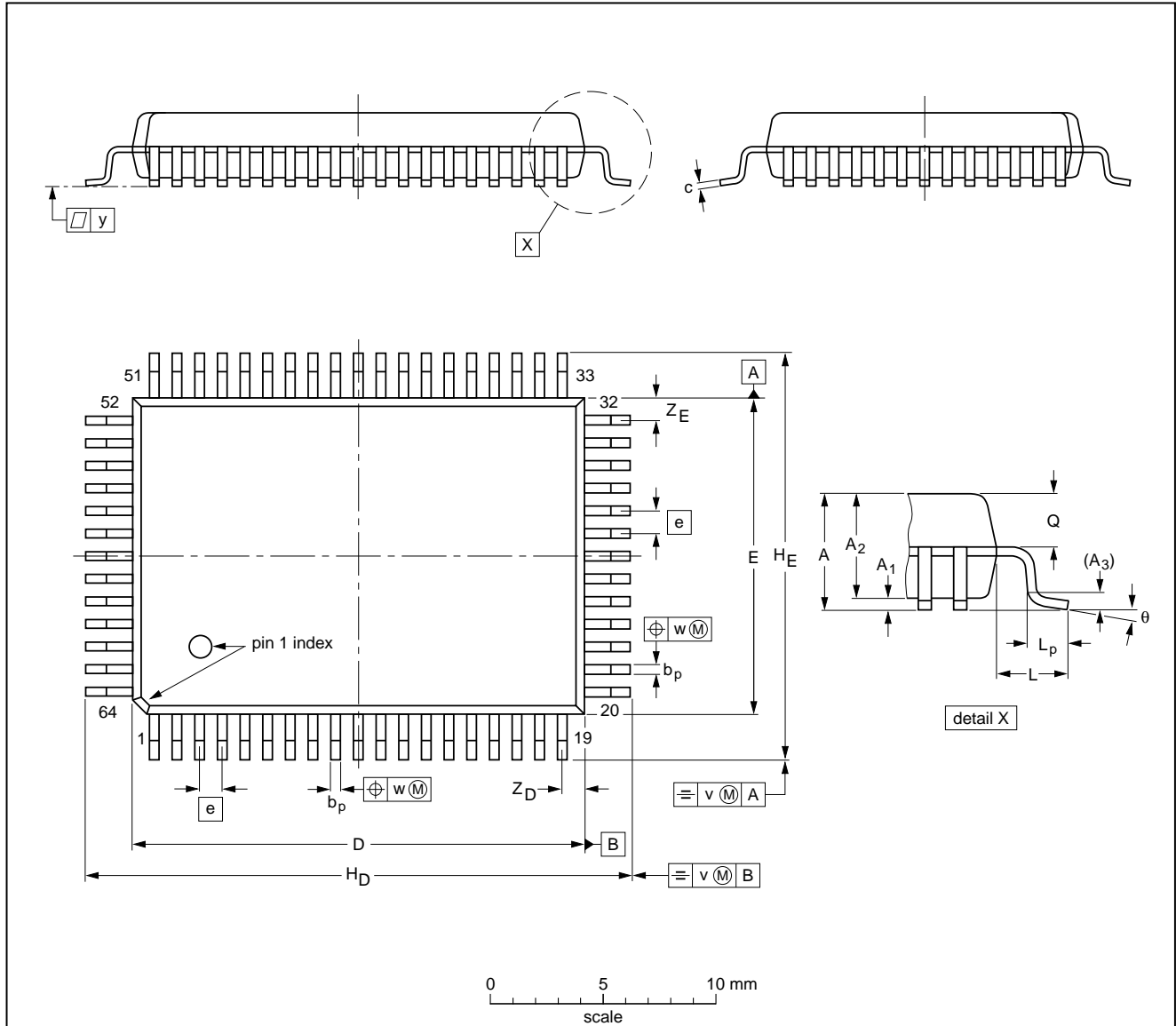

DIMENSIONS (mm are the original dimensions)

UNIT	A max.	A ₁	A ₂	A ₃	b _p	c	D ⁽¹⁾	E ⁽¹⁾	e	H _D	H _E	L	L _p	Q	v	w	y	Z _D ⁽¹⁾	Z _E ⁽¹⁾	θ
mm	3.20	0.25 0.05	2.90 2.65	0.25	0.50 0.35	0.25 0.14	20.1 19.9	14.1 13.9	1	24.2 23.6	18.2 17.6	1.95	1.0 0.6	1.4 1.2	0.2	0.2	0.1	1.2 0.8	1.2 0.8	7° 0°

Note

1. Plastic or metal protrusions of 0.25 mm maximum per side are not included.

OUTLINE VERSION	REFERENCES				EUROPEAN PROJECTION	ISSUE DATE
	IEC	JEDEC	EIAJ			
SOT319-2						92-11-17 95-02-04

VERTICAL Reconstruction IC (VERIC) for PALplus

SAA4997H

SOLDERING

Introduction

There is no soldering method that is ideal for all IC packages. Wave soldering is often preferred when through-hole and surface mounted components are mixed on one printed-circuit board. However, wave soldering is not always suitable for surface mounted ICs, or for printed-circuits with high population densities. In these situations reflow soldering is often used.

This text gives a very brief insight to a complex technology. A more in-depth account of soldering ICs can be found in our "IC Package Databook" (order code 9398 652 90011).

Reflow soldering

Reflow soldering techniques are suitable for all QFP packages.

The choice of heating method may be influenced by larger plastic QFP packages (44 leads, or more). If infrared or vapour phase heating is used and the large packages are not absolutely dry (less than 0.1% moisture content by weight), vaporization of the small amount of moisture in them can cause cracking of the plastic body. For more information, refer to the Drypack chapter in our "Quality Reference Handbook" (order code 9398 510 63011).

Reflow soldering requires solder paste (a suspension of fine solder particles, flux and binding agent) to be applied to the printed-circuit board by screen printing, stencilling or pressure-syringe dispensing before package placement.

Several techniques exist for reflowing; for example, thermal conduction by heated belt. Dwell times vary between 50 and 300 seconds depending on heating method. Typical reflow temperatures range from 215 to 250 °C.

Preheating is necessary to dry the paste and evaporate the binding agent. Preheating duration: 45 minutes at 45 °C.

Wave soldering

Wave soldering is **not** recommended for QFP packages. This is because of the likelihood of solder bridging due to closely-spaced leads and the possibility of incomplete solder penetration in multi-lead devices.

If wave soldering cannot be avoided, the following conditions must be observed:

- **A double-wave (a turbulent wave with high upward pressure followed by a smooth laminar wave) soldering technique should be used.**
- **The footprint must be at an angle of 45° to the board direction and must incorporate solder thieves downstream and at the side corners.**

Even with these conditions, do not consider wave soldering the following packages: QFP52 (SOT379-1), QFP100 (SOT317-1), QFP100 (SOT317-2), QFP100 (SOT382-1) or QFP160 (SOT322-1).

During placement and before soldering, the package must be fixed with a droplet of adhesive. The adhesive can be applied by screen printing, pin transfer or syringe dispensing. The package can be soldered after the adhesive is cured.

Maximum permissible solder temperature is 260 °C, and maximum duration of package immersion in solder is 10 seconds, if cooled to less than 150 °C within 6 seconds. Typical dwell time is 4 seconds at 250 °C.

A mildly-activated flux will eliminate the need for removal of corrosive residues in most applications.

Repairing soldered joints

Fix the component by first soldering two diagonally-opposite end leads. Use only a low voltage soldering iron (less than 24 V) applied to the flat part of the lead. Contact time must be limited to 10 seconds at up to 300 °C. When using a dedicated tool, all other leads can be soldered in one operation within 2 to 5 seconds between 270 and 320 °C.

VERTICAL RECONSTRUCTION IC (VERIC) for PALplus

SAA4997H

DEFINITIONS

Data sheet status	
Objective specification	This data sheet contains target or goal specifications for product development.
Preliminary specification	This data sheet contains preliminary data; supplementary data may be published later.
Product specification	This data sheet contains final product specifications.
Limiting values	
Limiting values given are in accordance with the Absolute Maximum Rating System (IEC 134). Stress above one or more of the limiting values may cause permanent damage to the device. These are stress ratings only and operation of the device at these or at any other conditions above those given in the Characteristics sections of the specification is not implied. Exposure to limiting values for extended periods may affect device reliability.	
Application information	
Where application information is given, it is advisory and does not form part of the specification.	

LIFE SUPPORT APPLICATIONS

These products are not designed for use in life support appliances, devices, or systems where malfunction of these products can reasonably be expected to result in personal injury. Philips customers using or selling these products for use in such applications do so at their own risk and agree to fully indemnify Philips for any damages resulting from such improper use or sale.

VERTical Reconstruction IC (VERIC) for
PALplus

SAA4997H

NOTES

VERTical Reconstruction IC (VERIC) for
PALplus

SAA4997H

NOTES

Philips Semiconductors – a worldwide company

Argentina: see South America

Australia: 34 Waterloo Road, NORTH RYDE, NSW 2113,
Tel. +61 2 9805 4455, Fax. +61 2 9805 4466

Austria: Computerstr. 6, A-1101 WIEN, P.O. Box 213,
Tel. +43 1 60 101, Fax. +43 1 60 101 1210

Belarus: Hotel Minsk Business Center, Bld. 3, r. 1211, Volodarski Str. 6,
220050 MINSK, Tel. +375 172 200 733, Fax. +375 172 200 773

Belgium: see The Netherlands

Brazil: see South America

Bulgaria: Philips Bulgaria Ltd., Energoproject, 15th floor,
51 James Bourchier Blvd., 1407 SOFIA,
Tel. +359 2 689 211, Fax. +359 2 689 102

Canada: PHILIPS SEMICONDUCTORS/COMPONENTS,
Tel. +1 800 234 7381

China/Hong Kong: 501 Hong Kong Industrial Technology Centre,
72 Tat Chee Avenue, Kowloon Tong, HONG KONG,
Tel. +852 2319 7888, Fax. +852 2319 7700

Colombia: see South America

Czech Republic: see Austria

Denmark: Prags Boulevard 80, PB 1919, DK-2300 COPENHAGEN S,
Tel. +45 32 88 2636, Fax. +45 31 57 1949

Finland: Sinikalliontie 3, FIN-02630 ESPOO,
Tel. +358 9 615800, Fax. +358 9 61580/xxx

France: 4 Rue du Port-aux-Vins, BP317, 92156 SURESNES Cedex,
Tel. +33 1 40 99 6161, Fax. +33 1 40 99 6427

Germany: Hammerbrookstraße 69, D-20097 HAMBURG,
Tel. +49 40 23 53 60, Fax. +49 40 23 536 300

Greece: No. 15, 25th March Street, GR 17778 TAVROS/ATHENS,
Tel. +30 1 4894 339/239, Fax. +30 1 4814 240

Hungary: see Austria

India: Philips INDIA Ltd, Shivsagar Estate, A Block, Dr. Annie Besant Rd.
Worli, MUMBAI 400 018, Tel. +91 22 4938 541, Fax. +91 22 4938 722

Indonesia: see Singapore

Ireland: Newstead, Clonskeagh, DUBLIN 14,
Tel. +353 1 7640 000, Fax. +353 1 7640 200

Israel: RAPAC Electronics, 7 Kehilat Saloniki St, TEL AVIV 61180,
Tel. +972 3 645 0444, Fax. +972 3 649 1007

Italy: PHILIPS SEMICONDUCTORS, Piazza IV Novembre 3,
20124 MILANO, Tel. +39 2 6752 2531, Fax. +39 2 6752 2557

Japan: Philips Bldg 13-37, Kohnan 2-chome, Minato-ku, TOKYO 108,
Tel. +81 3 3740 5130, Fax. +81 3 3740 5077

Korea: Philips House, 260-199 Itaewon-dong, Yongsan-ku, SEOUL,
Tel. +82 2 709 1412, Fax. +82 2 709 1415

Malaysia: No. 76 Jalan Universiti, 46200 PETALING JAYA, SELANGOR,
Tel. +60 3 750 5214, Fax. +60 3 757 4880

Mexico: 5900 Gateway East, Suite 200, EL PASO, TEXAS 79905,
Tel. +9-5 800 234 7381

Middle East: see Italy

Netherlands: Postbus 90050, 5600 PB EINDHOVEN, Bldg. VB,
Tel. +31 40 27 82785, Fax. +31 40 27 88399

New Zealand: 2 Wagener Place, C.P.O. Box 1041, AUCKLAND,
Tel. +64 9 849 4160, Fax. +64 9 849 7811

Norway: Box 1, Manglerud 0612, OSLO,
Tel. +47 22 74 8000, Fax. +47 22 74 8341

Philippines: Philips Semiconductors Philippines Inc.,
106 Valero St. Salcedo Village, P.O. Box 2108 MCC, MAKATI,
Metro MANILA, Tel. +63 2 816 6380, Fax. +63 2 817 3474

Poland: Ul. Lukiska 10, PL 04-123 WARSZAWA,
Tel. +48 22 612 2831, Fax. +48 22 612 2327

Portugal: see Spain

Romania: see Italy

Russia: Philips Russia, Ul. Usatcheva 35A, 119048 MOSCOW,
Tel. +7 095 247 9145, Fax. +7 095 247 9144

Singapore: Lorong 1, Toa Payoh, SINGAPORE 1231,
Tel. +65 350 2538, Fax. +65 251 6500

Slovakia: see Austria

Slovenia: see Italy

South Africa: S.A. PHILIPS Pty Ltd., 195-215 Main Road Martindale,
2092 JOHANNESBURG, P.O. Box 7430 Johannesburg 2000,
Tel. +27 11 470 5911, Fax. +27 11 470 5494

South America: Rua do Rocio 220, 5th floor, Suite 51,
04552-903 São Paulo, SÃO PAULO - SP, Brazil,
Tel. +55 11 821 2333, Fax. +55 11 829 1849

Spain: Balmes 22, 08007 BARCELONA,
Tel. +34 3 301 6312, Fax. +34 3 301 4107

Sweden: Kottbygatan 7, Akalla, S-16485 STOCKHOLM,
Tel. +46 8 632 2000, Fax. +46 8 632 2745

Switzerland: Allmendstrasse 140, CH-8027 ZÜRICH,
Tel. +41 1 488 2686, Fax. +41 1 481 7730

Taiwan: PHILIPS TAIWAN Ltd., 23-30F, 66,
Chung Hsiao West Road, Sec. 1, P.O. Box 22978,
TAIPEI 100, Tel. +886 2 382 4443, Fax. +886 2 382 4444

Thailand: PHILIPS ELECTRONICS (THAILAND) Ltd.,
209/2 Sanpavuth-Bangna Road Prakanong, BANGKOK 10260,
Tel. +66 2 745 4090, Fax. +66 2 398 0793

Turkey: Talatpasa Cad. No. 5, 80640 GÜLTEPE/ISTANBUL,
Tel. +90 212 279 2770, Fax. +90 212 282 6707

Ukraine: PHILIPS UKRAINE, 4 Patrice Lumumba str., Building B, Floor 7,
252042 KIEV, Tel. +380 44 264 2776, Fax. +380 44 268 0461

United Kingdom: Philips Semiconductors Ltd., 276 Bath Road, Hayes,
MIDDLESEX UB3 5BX, Tel. +44 181 730 5000, Fax. +44 181 754 8421

United States: 811 East Arques Avenue, SUNNYVALE, CA 94088-3409,
Tel. +1 800 234 7381

Uruguay: see South America

Vietnam: see Singapore

Yugoslavia: PHILIPS, Trg N. Pasica 5/v, 11000 BEOGRAD,
Tel. +381 11 625 344, Fax. +381 11 635 777

For all other countries apply to: Philips Semiconductors, Marketing & Sales Communications,
Building BE-p, P.O. Box 218, 5600 MD EINDHOVEN, The Netherlands, Fax. +31 40 27 24825

Internet: <http://www.semiconductors.philips.com>

© Philips Electronics N.V. 1996

SCA52

All rights are reserved. Reproduction in whole or in part is prohibited without the prior written consent of the copyright owner.

The information presented in this document does not form part of any quotation or contract, is believed to be accurate and reliable and may be changed without notice. No liability will be accepted by the publisher for any consequence of its use. Publication thereof does not convey nor imply any license under patent- or other industrial or intellectual property rights.

Printed in The Netherlands

537021/1200/01/pp28

Date of release: 1996 Oct 24

Document order number: 9397 750 01423

Let's make things better.

Philips
Semiconductors



PHILIPS