

Bias Resistor Transistor

PNP Silicon Surface Mount Transistor with Monolithic Bias Resistor Network

This new series of digital transistors is designed to replace a single device and its external resistor bias network. The BRT (Bias Resistor Transistor) contains a single transistor with a monolithic bias network consisting of two resistors; a series base resistor and a base-emitter resistor. The BRT eliminates these individual components by integrating them into a single device. The use of a BRT can reduce both system cost and board space. The device is housed in the SC-59 package which is designed for low power surface mount applications.

- Simplifies Circuit Design
- Reduces Board Space
- Reduces Component Count
- The SC-59 package can be soldered using wave or reflow.

The modified gull-winged leads absorb thermal stress during soldering eliminating the possibility of damage to the die.

- Available in 8 mm embossed tape and reel

Use the Device Number to order the 7 inch/3000 unit reel.

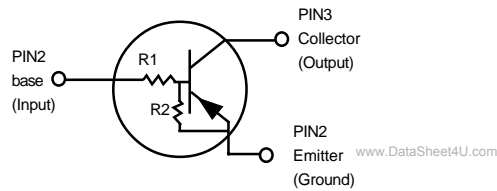

MUN2111RT1
MUN2112RT1
MUN2113RT1
MUN2114RT1
MUN2115RT1
MUN2116RT1
MUN2130RT1
MUN2131RT1
MUN2132RT1
MUN2133RT1
MUN2134RT1

PNP SILICON
BIAS RESISTOR
TRANSISTOR



CASE 318-03, STYLE 1
(SC-59)

MAXIMUM RATINGS (T_A = 25°C unless otherwise noted)

Rating	Symbol	Value	Unit
Collector-Base Voltage	V _{CBO}	50	Vdc
Collector-Emitter Voltage	V _{CEO}	50	Vdc
Collector Current	I _C	100	mAdc
Total Power Dissipation @ T _A = 25°C ⁽¹⁾	P _D	200	mW
Derate above 25°C		1.6	mW/°C

THERMAL CHARACTERISTICS

Rating	Symbol	Value	Unit
Thermal Resistance — Junction-to-Ambient (surface mounted)	R _{θJA}	625	°C/W
Operating and Storage Temperature Range	T _J , T _{stg}	-65 to +150	°C
Maximum Temperature for Soldering Purposes	T _L	260	°C
Time in Solder Bath		10	Sec

DEVICE MARKING AND RESISTOR VALUES

Device	Marking	R1 (K)	R2 (K)
MUN2111RT1	6A	10	10
MUN2112RT1	6B	22	22
MUN2113RT1	6C	47	47
MUN2114RT1	6D	10	47
MUN2115RT1 ⁽²⁾	6E	10	∞
MUN2116RT1 ⁽²⁾	6F	4.7	∞
MUN2130RT1 ⁽²⁾	6G	1.0	1.0
MUN2131RT1 ⁽²⁾	6H	2.2	2.2
MUN2132RT1 ⁽²⁾	6J	4.7	4.7
MUN2133RT1 ⁽²⁾	6K	4.7	47
MUN2134RT1 ⁽²⁾	6L	22	47

1. Device mounted on a FR-4 glass epoxy printed circuit board using the minimum recommended footprint.
2. New devices. Updated curves to follow in subsequent data sheets.

MUN2111RT1 SERIES

ELECTRICAL CHARACTERISTICS (T_A = 25°C unless otherwise noted)

Characteristic	Symbol	Min	Typ	Max	Unit
----------------	--------	-----	-----	-----	------

OFF CHARACTERISTICS

Collector-Base Cutoff Current (V _{CB} =50V, I _E = 0)	I _{CBO}	-	-	100	nAdc	
Collector-Emitter Cutoff Current (V _{CE} = 50 V, I _B = 0)	I _{CEO}	-	-	500	nAdc	
Emitter-Base Cutoff Current (V _{EB} = 6.0 V, I _C = 0)	MUN2111RT1	I _{EBO}	-	-	0.5	mAdc
	MUN2112RT1		-	-	0.2	
	MUN2113RT1		-	-	0.1	
	MUN2114RT1		-	-	0.2	
	MUN2115RT1		-	-	0.9	
	MUN2116RT1		-	-	1.9	
	MUN2130RT1		-	-	4.3	
	MUN2131RT1		-	-	2.3	
	MUN2132RT1		-	-	1.5	
	MUN2133RT1		-	-	0.18	
MUN2134RT1		-	-	0.13		
Collector-Base Breakdown Voltage (I _C = 10 μA, I _E = 0)	V _{(BR)CBO}	50	-	-	Vdc	
Collector-Emitter Breakdown Voltage ⁽³⁾ (I _C =2.0mA, I _B =0)	V _{(BR)CEO}	50	-	-	Vdc	

ON CHARACTERISTICS ⁽³⁾

DC Current Gain (V _{CE} = 10 V, I _C = 5.0 mA)	MUN2111RT1	h _{FE}	35	60	-
	MUN2112RT1		60	100	-
	MUN2113RT1		80	140	-
	MUN2114RT1		80	140	-
	MUN2115RT1		160	250	-
	MUN2116RT1		160	250	-
	MUN2130RT1		3.0	5.0	-
	MUN2131RT1		8.0	15	-
	MUN2132RT1		15	27	-
	MUN2133RT1		80	140	-
MUN2134RT1		80	130	-	
Collector-Emitter Saturation Voltage (I _C =10mA, I _E =0.3mA)	V _{CE(sat)}				Vdc
(I _C = 10 mA, I _B = 0.3 mA)	MUN2111RT1 MUN2112RT1 MUN2113RT1 MUN2114RT1 MUN2115RT1 MUN2130RT1		-	-	0.25
(I _C = 10 mA, I _B = 5.0 mA)	MUN2131RT1		-	-	0.25
(I _C = 10 mA, I _B = 1.0 mA)	MUN2116RT1 MUN2132RT1 MUN2134RT1		-	-	0.25
Output Voltage (on)	V _{OL}				Vdc
(V _{CC} =5.0V, V _B =2.5V, R _L =1.0kΩ)	MUN2111RT1 MUN2112RT1 MUN2114RT1 MUN2115RT1 MUN2116RT1 MUN2130RT1 MUN2131RT1 MUN2132RT1 MUN2133RT1 MUN2134RT1		-	-	0.2
(V _{CC} =5.0V, V _B =3.5V, R _L = 1.0kΩ)	MUN2113RT1		-	-	0.2

3. Pulse Test: Pulse Width < 300 ms, Duty Cycle < 2.0%

MUN211RT1 SERIES

ELECTRICAL CHARACTERISTICS (T_A = 25°C unless otherwise noted) (Continued)

Characteristic	Symbol	Min	Typ	Max	Unit
Output Voltage (off) (V _{CC} = 5.0V, V _B = 0.5 V, R _L = 1.0kΩ) (V _{CC} = 5.0V, V _B = 0.050 V, R _L =1.0kΩ) MUN2130RT1 (V _{CC} = 5.0V, V _B = 0.25 V, R _L =1.0kΩ) MUN2115RT1 MUN2116RT1 MUN2131RT1 MUN2132RT1	V _{OH}	4.9	—	—	Vdc
Input Resistor MUN2111RT1 MUN2112RT1 MUN2113RT1 MUN2114RT1 MUN2115RT1 MUN2116RT1 MUN2130RT1 MUN2131RT1 MUN2132RT1 MUN2133RT1 MUN2134RT1	R ₁	7.0 15.4 32.9 7.0 7.0 3.3 0.7 1.5 3.3 3.3 15.4	10 22 47 10 10 4.7 1.0 2.2 4.7 4.7 22	13 28.6 61.1 13 13 6.1 1.3 2.9 6.1 6.1 28.6	kΩ
Resistor Ratio MUN2111RT1 MUN2112RT1 MUN2113RT1 MUN2114RT1 MUN2115RT1 MUN2116RT1 MUN2130RT1 MUN2131RT1 MUN2132RT1 MUN2133RT1 MUN2134RT1	R ₁ /R ₂	0.8 0.17 — 0.8 0.055 0.38	1.0 0.21 — 1.0 0.1 0.47	1.2 0.25 — 1.2 0.185 0.56	

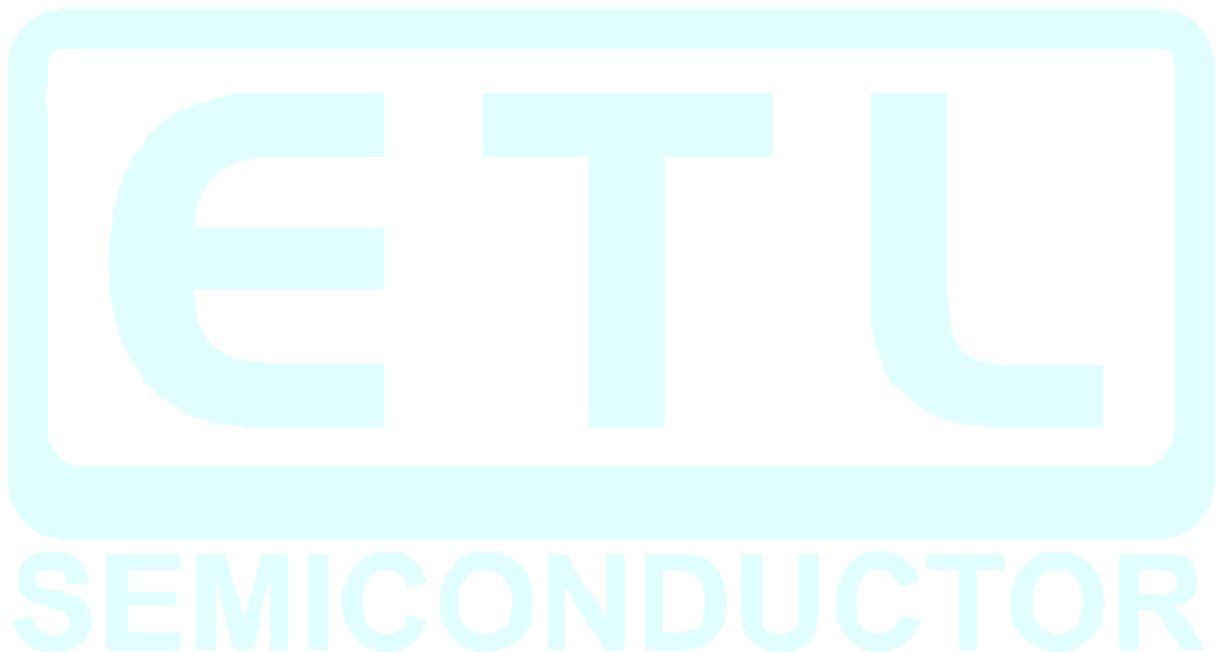

TYPICAL ELECTRICAL CHARACTERISTICS
MUN2111RT1

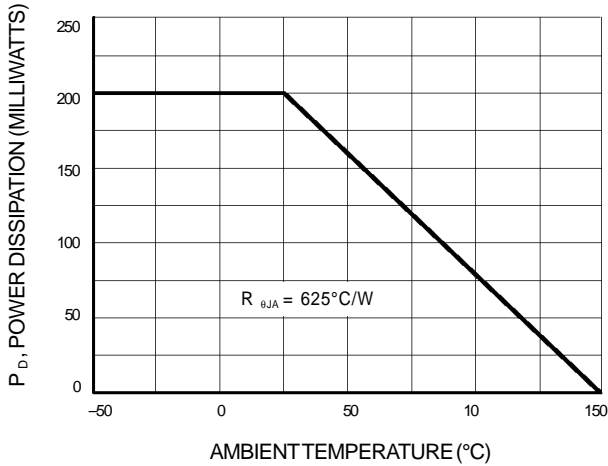

Figure 1. Derating Curve

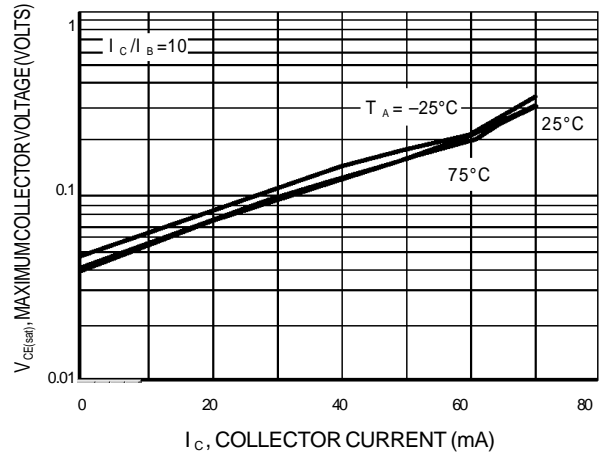

Figure 2. $V_{CE(sat)}$ versus I_C

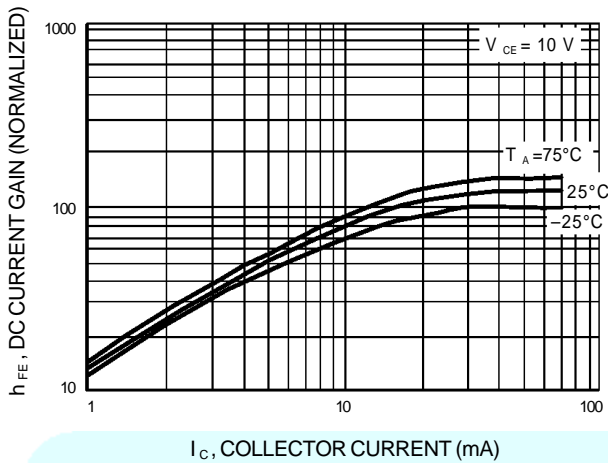

Figure 3. DC Current Gain

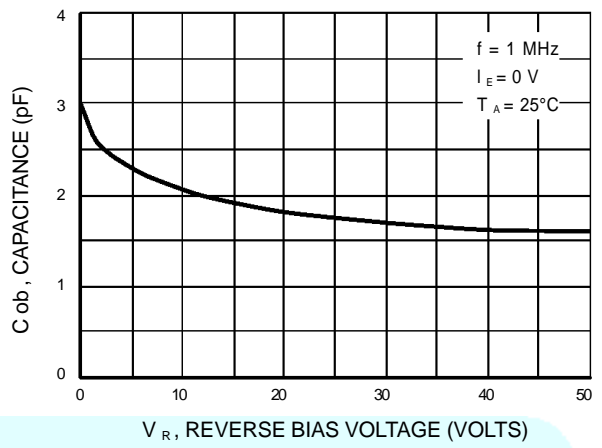

Figure 4. Output Capacitance

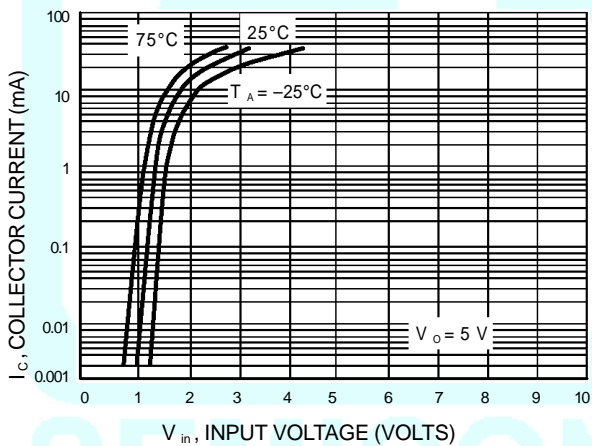

Figure 5. Output Current versus Input Voltage

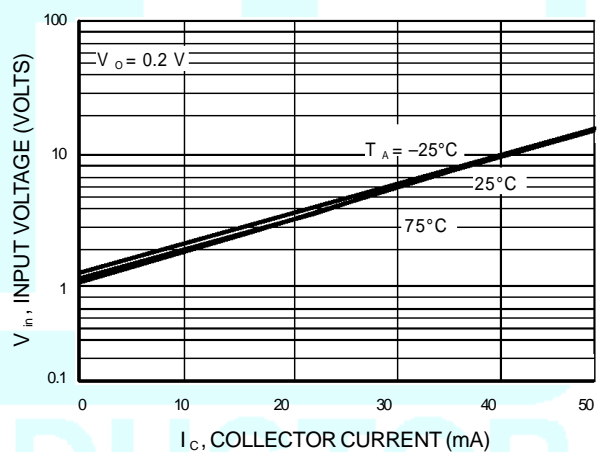

Figure 6. Input Voltage versus Output Current

MUN2111RT1 SERIES

TYPICAL ELECTRICAL CHARACTERISTICS MUN2112RT1

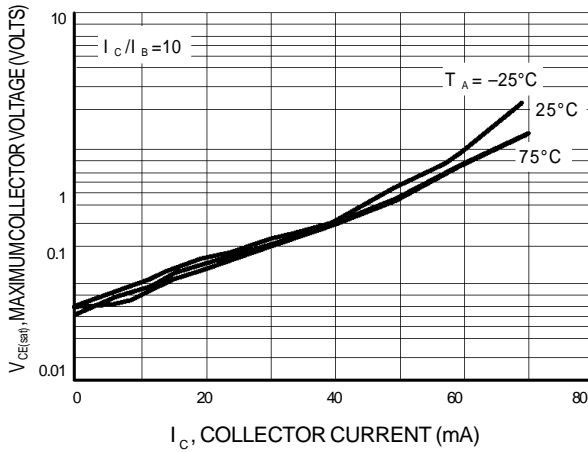

Figure 7. $V_{CE(sat)}$ versus I_C

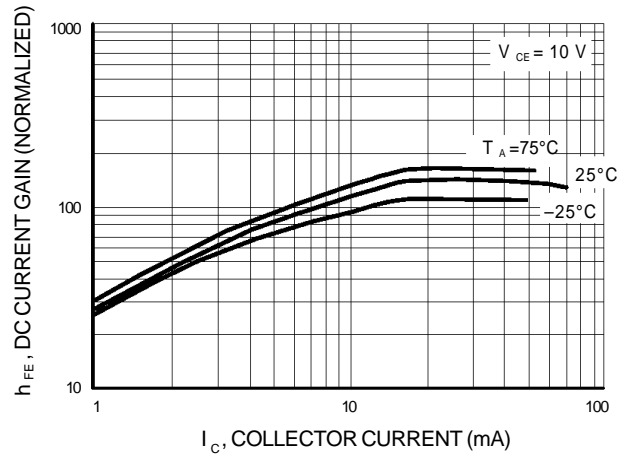

Figure 8. DC Current Gain

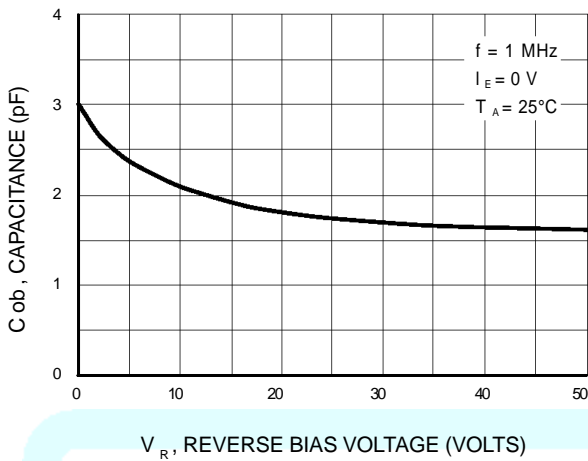

Figure 9. Output Capacitance

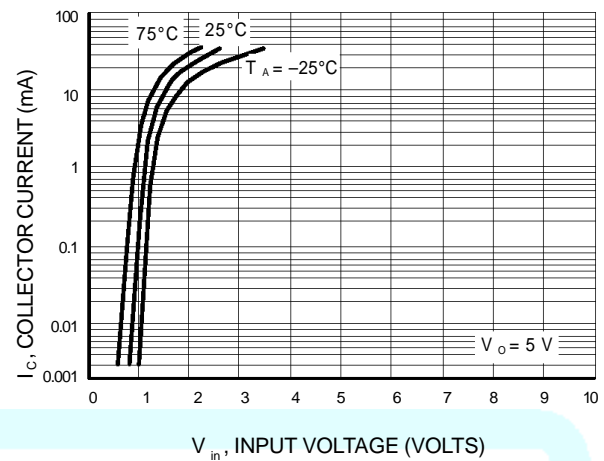

Figure 10. Output Current versus Input Voltage

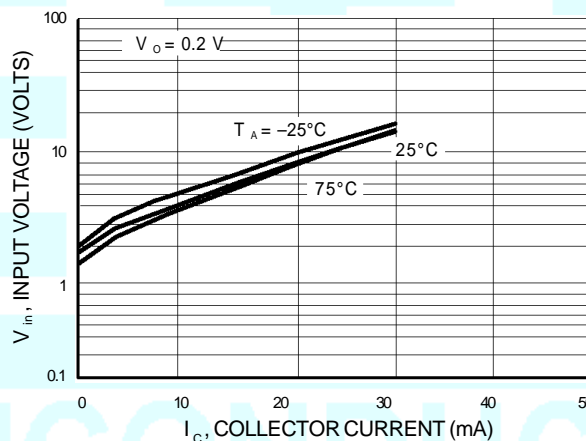

Figure 11. Input Voltage versus Output Current

TYPICAL ELECTRICAL CHARACTERISTICS
MUN2113RT1

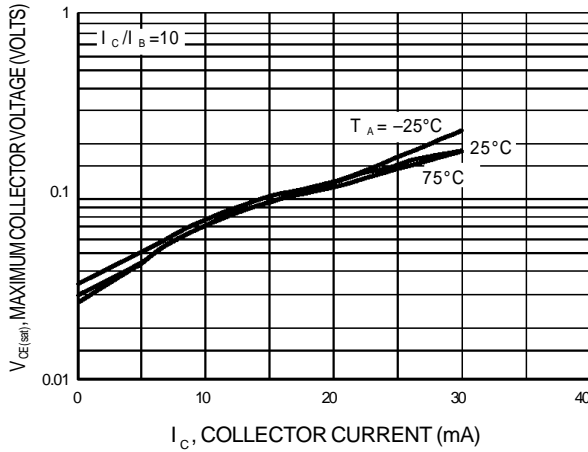

Figure 12. $V_{CE(sat)}$ versus I_C

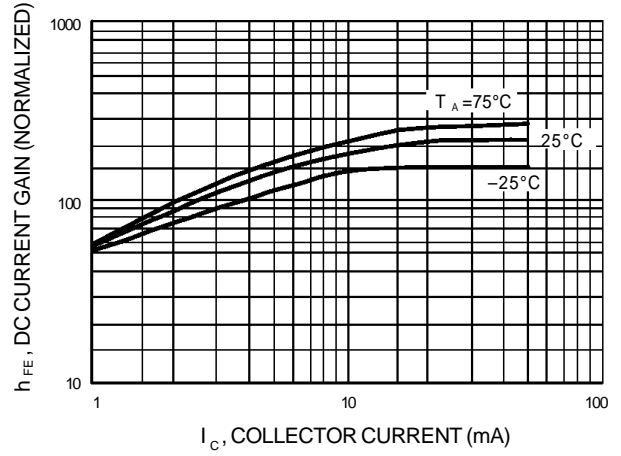

Figure 13. DC Current Gain

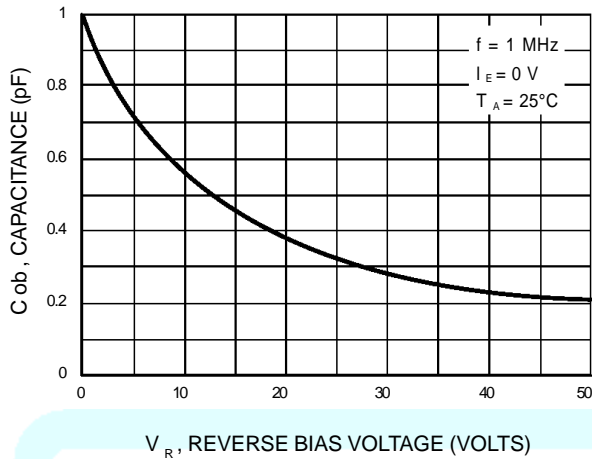

Figure 14. Output Capacitance

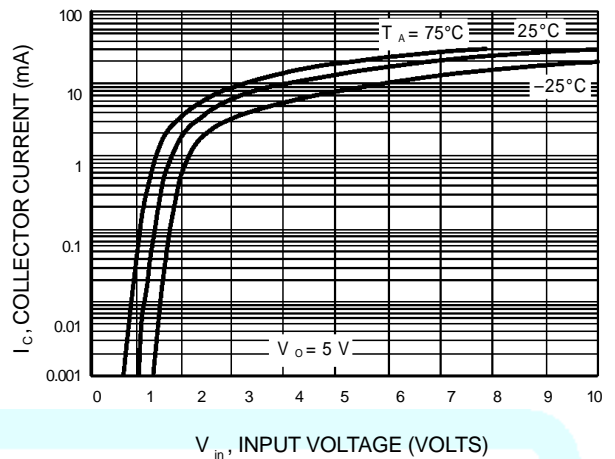

Figure 15. Output Current versus Input Voltage

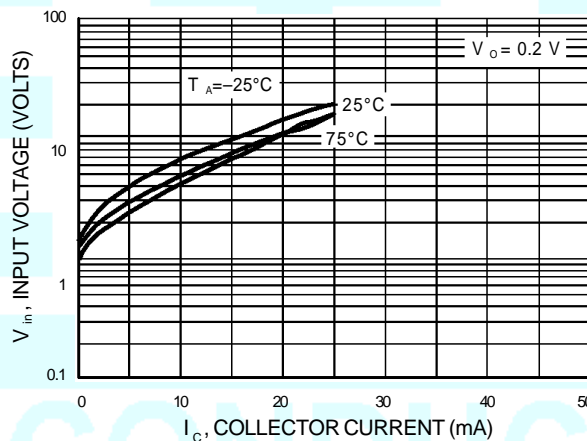

Figure 16. Input Voltage versus Output Current

TYPICAL ELECTRICAL CHARACTERISTICS
MUN2114RT1

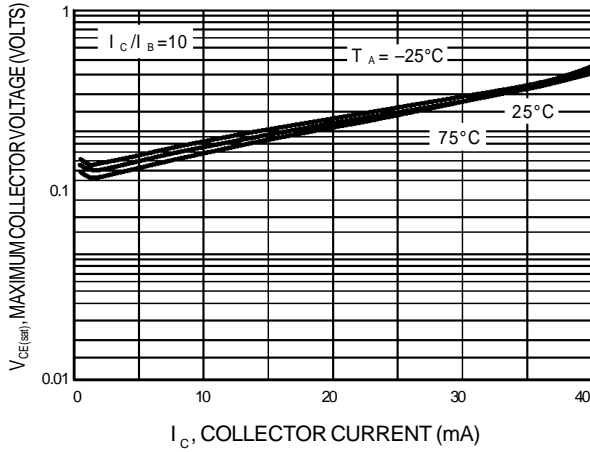

Figure 17. $V_{CE(sat)}$ versus I_C

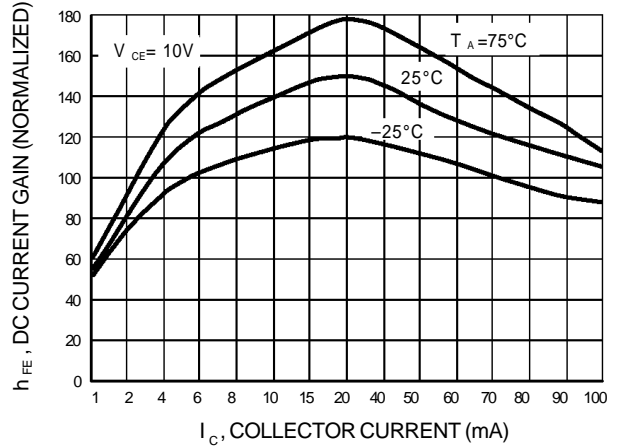

Figure 18. DC Current Gain

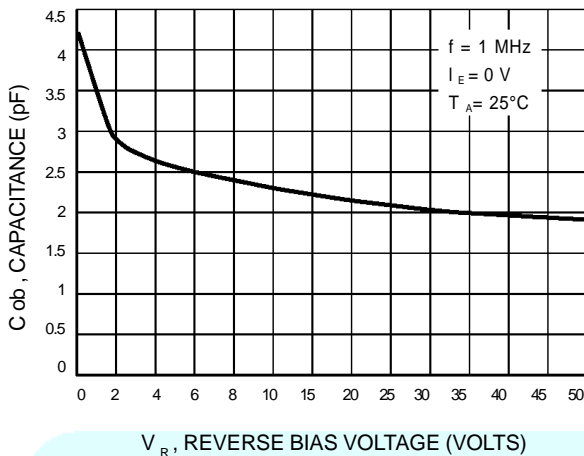

Figure 19. Output Capacitance

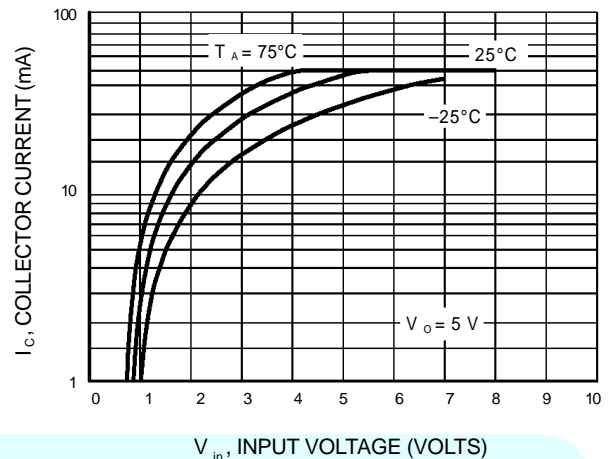

Figure 20. Output Current versus Input Voltage

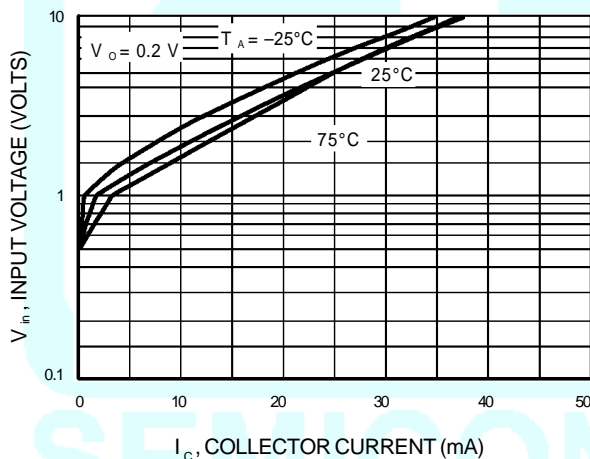

Figure 21. Input Voltage versus Output Current

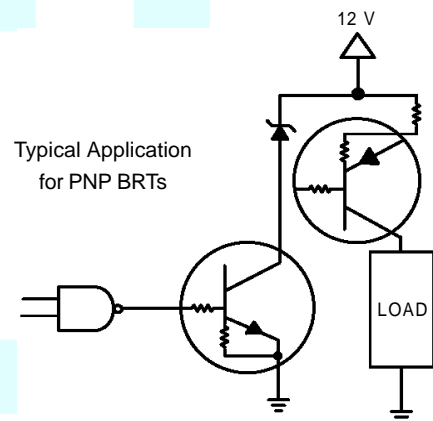

Figure 22. Inexpensive, Unregulated Current Source