

Evaluation Board for the SA2005M and SA2005P Energy Metering IC's



sames

PM2005M/P

FEATURES

- Designed to be used as fully functional Watt-Hour meter.
- Better than Class 1 operation
- On-board power supply
- 3 Phase 4 Wire configuration
- On-board current transformers
- Measured energy pulse output LED
- Individual phase direction indication
- Individual phase fail and error condition indication

SA2005M specific:

- Selectable dividing ratios for different rated conditions
- Selectable calibration LED resolution and assuming mode

SA2005P specific:

- Calibration and setup data stored on an external EEPROM
- Flexible programmable features

DESCRIPTION

The SA2005M IC is a single-chip solution with pin programmable features. The SA2005P IC is also a single-chip solution and retrieves its configuration and calibration information from an external EEPROM. More detailed information specific to the SA2005M or SA2005P can be found in the applicable Datasheets.

The PM2005M/P evaluation board has been designed to be a

fully functional watt-hour meter for three-phase four-wire applications using either the SA2005M or SA2005P. The mains voltages easily connect to the module by way of a Molex connector (SK1). The 3 on-board current transformers measure the current in each phase. A simple capacitive power supply supplies the energy metering IC with power. The LM431 regulators are used to generate 5V supply voltage for the IC on the board.

DataSheet4U.com

DataSheet4U.com

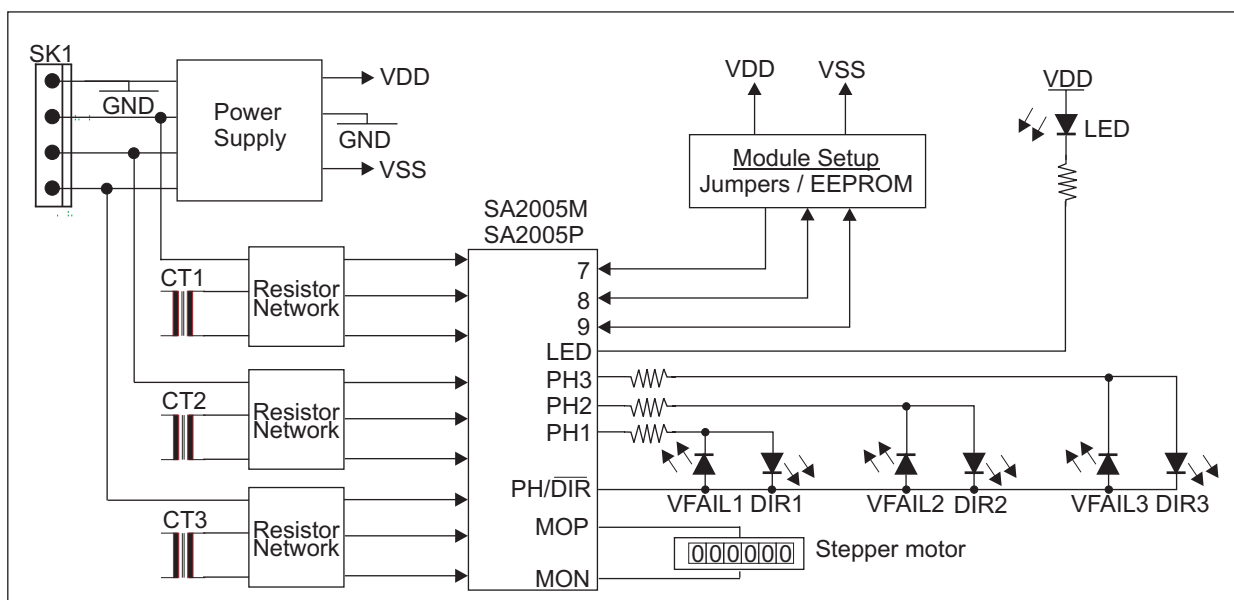

Figure 1: Block diagram



PM2005M/P

SETTING UP THE PM2005M/P MODULE

JUMPER DESCRIPTION

Power Supply Jumpers

The power supply jumpers are used to disconnect the on-board power supply, allowing the metering section of the circuit to be powered from an external power supply if required.

Jumper	Description
J4	Connects VDD to the metering circuitry.
J5	Connects VSS to the metering circuitry.
J6	GND connection point.
J7	Connection point between the power supply GND (N) and the SA2005 GND

Voltage Selection Jumpers

These jumpers are used to select between 115V and 230V operation. When closed the jumpers will half the series resistance in the voltage divider to the voltage sense inputs.

Jumper	230V	115V
J1	Open	Closed
J2	Open	Closed
J3	Open	Closed

Module Setup Jumpers

The following jumpers (S1 and S9) are used to set the various dividing ratios, resolution and summing modes.

Setup for use with the SA2005M

Jumpers S1 to S3 set the rated conditions dividing ratio (pin RA of the SA2005M). **Please note that only one jumper should be closed at any one time. Closing more than one jumper may short circuit the power supply.**

State	Description	Voltage Level on Pin 7 of the SA2005
Only S1 closed	Select a multiplying ratio of 3/3	VDD
Only S2 closed	Select a multiplying ratio of 1/3	VSS
Only S3 closed	Select a multiplying ratio of 2/3	PH/DIR=100Hz
S1, S2 and S3 open	Select a 1252Hz pulse rate at rated input conditions	Floating

Jumpers S4 to S6 set the calibration LED resolution (dividing ratio) as well as the summing mode (pin RE of the SA2005M). **Please note that only one jumper should be closed at any one time. Closing more than one jumper may short circuit the power supply.**

State	Summing Mode	LED dividing ratio	Voltage Level on pin 8 of the SA2005
Only S4 closed	Absolute sum	4	VDD
Only S5 closed	Total sum	1	VSS
Only S6 closed	Total sum	4	PH/DIR=100Hz
S4, S5 and S6 open	Absolute sum	1	Floating

Jumpers S7 to S9 sets the dividing ratio (counter resolution, pin IM of the SA2005M) for the SA2005M's motor drive output. **Please note that only one jumper should be closed at any one time. Closing more than one jumper may short circuit the power supply.**

State	Dividing ratio (counter resolution)	Voltage Level on Pin 9 of the SA2005
Only S7 closed	1 (100 pulse/kWh)	VDD
Only S8 closed	100 (1 pulse/kWh)	VSS
Only S9 closed	10 (10 pulse/kWh)	PH/DIR=100Hz
S7, S8 and S9 open	Test Mode	Floating

Set-up for use with the SA2005P

Jumpers S1 to S9 must be removed (open), so as not to influence the functionality of the IIC bus operation. Jumper S10 may be used on certain IIC EEPROMS to protect the data written to the EEPROM. This jumper must be opened when programming the EEPROM.

PM2005M/P

CONNECTOR DESCRIPTION

SK1

Connects the three phase 4 wire supply to the module.

J8 (SA2005P only)

Programming interface for the IIC EEPROM.

Note that the usual pull up resistors associated with devices on a IIC bus is integrated in the SA2005P IC. The SA2005P's CL input is a weak driver and can be overdriven by any external signal. Loading of this pin with external circuitry may influence the SA2005P's ability to reload its registers from the EEPROM.

Number	Signal Name	SA2005P (U1)	24C01 (U2)
1	VDD	Pin 6	Pin 8
2	VSS	Pin 14	Pin 1, 2, 3, 4
3	SCL	Pin 8	Pin 6
4	SDA	Pin 9	Pin 5
5	RLOAD	Pin 7	NC

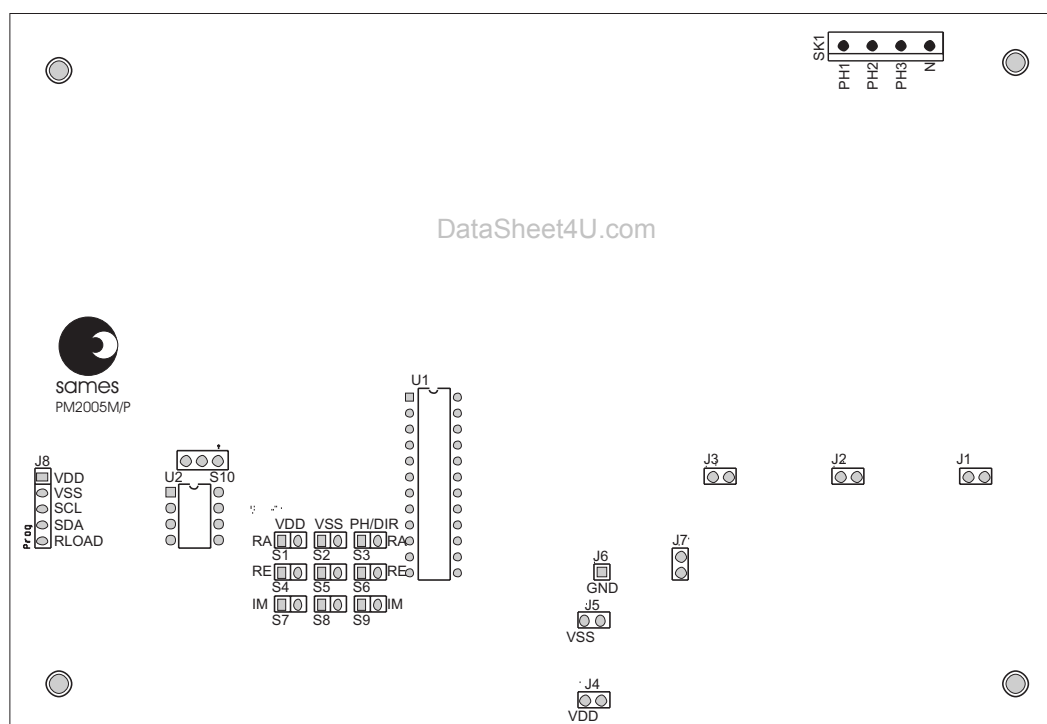

Figure 2: Jumper positions

PM2005M/P

SETTING UP THE MODULE FOR ENERGY MEASUREMENT

Figure 3 below shows a typical setup for the PM2005M/P evaluation module. The three phase voltages are connected directly to SK1 and each corresponding phase current is wired through the on-board CT's.

Figure 3 also shows the default jumper settings. The PM2005M/P evaluation module is setup by default for

3x230V/60A operation. For 3x 115V operation jumpers J1, J2 and J3 need to be closed and capacitors C12, C13 and C14 values must be changed to $1\mu\text{F} / 150\text{VAC}$.

As soon as a load is applied, the pulse LED L7 will start flashing and the energy counter will increment proportional to the energy measured.

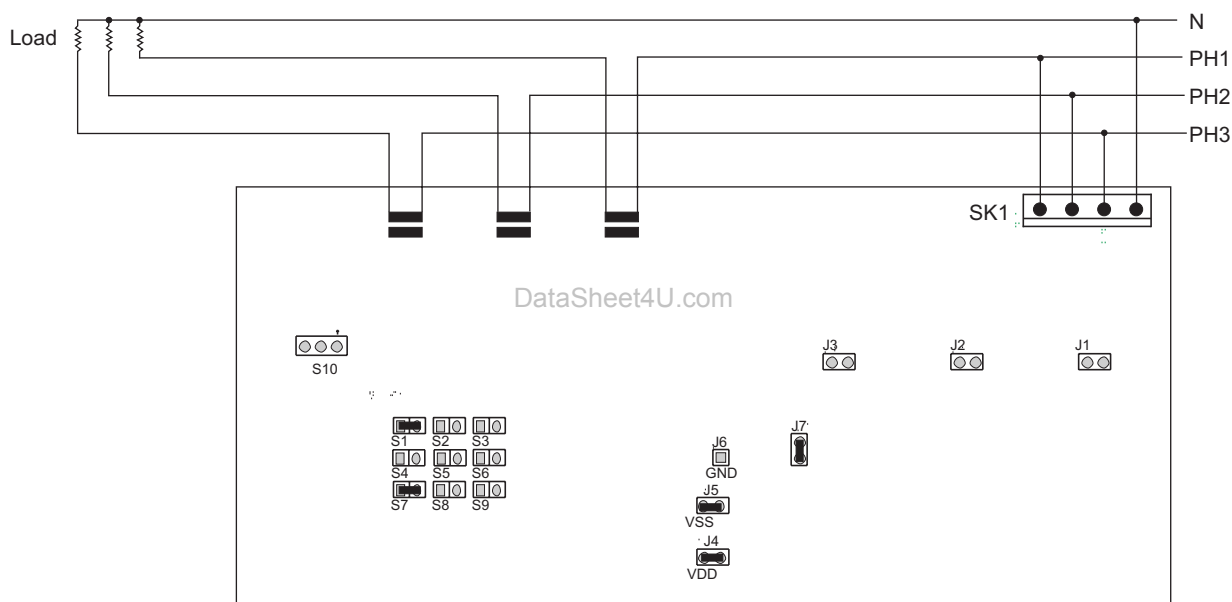

Figure 3: PM2005M/P setup and connection

PM2005M/P

CIRCUIT DESCRIPTION

ANALOG SECTION

The analog (metering) interface described in this section is designed for measuring 3x 230V/60A with precision better than Class 1.

The most important external components for the SA2005M and SA2005P integrated circuit are the current sense resistors, the voltage sense resistors and the bias setting resistor. The resistors used in the metering section should be of the same type so that temperature effects are minimized.

BIAS RESISTOR

Pin VREF (SA2005M or P pin 19) is connected to VSS via R7 which determines the on chip bias current. With R7 = 24kΩ optimum conditions are set. VREF does not require any additional circuitry.

CT TERMINATION RESISTOR

The voltage drop across the CT termination resistor at rated current should be at least 16mV. The CT's used have low phase shift and a ratio of 1:2500. The CT is terminated with a 3.6Ω resistor giving a voltage drop across the termination resistor 86.4mV at rated conditions (Imax for the meter).

CURRENT SENSOR INPUT RESISTORS

Referring to figure 4 the resistors R1 and R2 define the current levels into the SA2005's current sense inputs (phase on IIP1 and IIN1). The resistor values are selected for an input current of 16μA into the current inputs at rated conditions. According to the equation described in the Current Sense inputs section of the datasheet:

$$R1 = R2 = (I / 16\mu A) \times R_{SH} / 2$$

$$= 60A / 2500 / 16\mu A \times 3.6\Omega / 2$$

$$= 2.7k\Omega$$

I_L Line current / CT Ratio

The three current channels are identical so R1=R2=R3=R4=R5=R6.

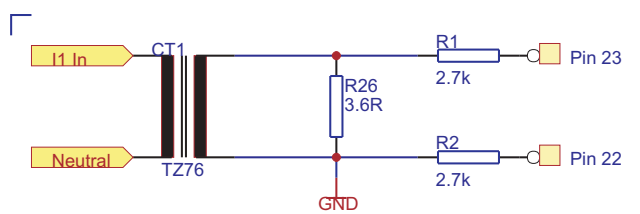

Figure 4: Current Input Configuration

VOLTAGE DIVIDER

Referring to figure 5 the connections for the voltage sense input for one phase is shown. The current into the A/D converter (IVP) is set 14μARMS at nominal mains voltage. This voltage sense input saturates at approximately 17μARMS. A nominal voltage current of 14μA allows for 20% over driving. Each mains voltage is divided down by a voltage divider to 14V. The current into the voltage sense input is set at 14μA via a 1MΩ resistor.

The following equation is used to calculate the 14V voltage drop:

$$RA = R22 + R23 + R24 + R25$$

$$RB = R8 \parallel (R13 + P1)$$

Combining the two equations gives:

$$(RA + RB) / 230V = RB / 14V$$

A 24kΩ resistor is chosen for R13 and P1 combined. A 1MΩ resistor is used for R8.

Substituting the values result in:

$$RB = 23.44k\Omega$$

$$RA = RB \times (230V / 14V - 1)$$

$$RA = 361.6k\Omega$$

Resistor values of R22, R24 are chosen to be 82kΩ and resistors R23 and R25 is chosen to be 100kΩ each.

The three voltage channels are identical so R14 = R16 = R18 = R20 = R22 = R24 = 82k and R15 = R17 = R19 = R21 = R23 = R25 = 100kΩ

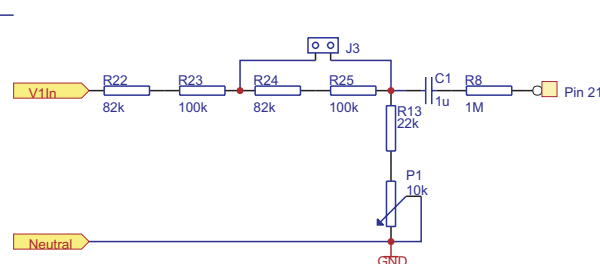

Figure 5: Mains Voltage Divider

The capacitors C1, C2 and C3 is used to compensate for phase shifts between the SA2005 voltage sense inputs and current sense inputs. The on-board Ct's were characterized and found to have a constant phase shift of 0.18 degrees. The value of the phase shift compensation capacitors were calculated as follows:

$$C = 1 / (2 \times \pi \times \text{Mains frequency} \times R5 \times \tan(\text{Phase shift angle}))$$

$$C = 1 / (2 \times \pi \times 50 \times 1M\Omega \times \tan(0.18 \text{ degrees}))$$

$$C = 1.013\mu F$$



PM2005M/P

POWER SUPPLY

Referring to figure 9, capacitor C10 is charged through D2 during the positive half of the sine wave from the R29, C12 mains voltage dropper. Identical charging circuitry exists for the other two phases. During the negative sine wave, C11 is charged through diode D1. The unregulated voltage charged on C10 and C11 is limited to 47 V by means of zener diode D7. Resistors R32 and R33 act as current limiting resistors that feed the unregulated voltage to the positive and negative voltage regulators U3 and U4. The voltage regulators need a load capacitance of around 10 μ F (C8 and C9) to be in a stable operating region. C15 acts as a supply voltage storage capacitor.

Jumpers J4, J5 and J7 allow the power supply to be completely disconnected from the metering section from the device.

PCB DESIGN

The module represents a Class 1 meter that is designed to demonstrate the functionality and performance of the SA2005M or SA2005P metering circuits. The SA2005M/P is single chip solution for a three-phase meter that drives a mechanical counter. When the meter PCB is designed, it should be taken into account that the SA2005 is a mixed signal integrated circuit and special care should be taken with the power supply and signal routing to the device.

Protection

The SA2005 should be protected from its measuring environment. This is achieved by using resistor dividers to scale all the SA2005 input signals. MOV's Z1, Z2, Z3 together with resistors R29, R30, R31 protects the power supply capacitors. The current setting resistors on the current sense inputs of the device attenuates common mode and asymmetrical transients.

Component placement

All the resistors connecting to the SA2005's current sense

inputs should be placed as close as possible to the SA2005. This eliminates the possibility of any stray signal coupling into the divided input signal.

Ground Plane

The GND pin of the SA2005 is connected to the neutral phase, which is halfway between VDD and VSS. Note that supply bypass capacitors C4 and C5 are positioned as close as possible to the supply pins of the SA2005, and connected to a solid ground plane. Capacitor C6 is positioned as close as possible to the supply pins of the device for proper supply bypassing.

Power Supply routing and de coupling

The 5V supply is de-coupled and routed directly to the power pins of the IC by means of capacitor C5. Care is taken not to have current flowing in the node that connects the voltage reference resistor to VSS as it may introduce power supply noise on the voltage reference circuit.

Signal Routing

Most of the signal routing is done in such a manner that any signal coupling in to the measured signal will be a common mode noise signal and is rejected subsequently. Care should be taken that the signals to the SA2005 is not influenced by other sources such as transformers with electric fields coupling in to the signals.

Calibration

Calibration can be done by adjusting the trimpots (P1, P2, P3) connected to the three voltage inputs.

I _{max}	V _{max}	RA	RE	IM	LED Pulse rate (Pulses/kWh)	Motor Pulse Rate (Pulses/kWh)
10	230	PH/ $\overline{\text{DIR}}$	PH/ $\overline{\text{DIR}}$ or VDD	VDD	3200	800
20	230	PH/ $\overline{\text{DIR}}$	PH/ $\overline{\text{DIR}}$ or VDD	VDD	1600	400
30	230	VDD	PH/ $\overline{\text{DIR}}$ or VDD	VDD	1600	400
40	230	PH/ $\overline{\text{DIR}}$	VSS or Open	VDD	3200	200
60	230	VDD	VSS or Open	VDD	3200	200
80	230	PH/ $\overline{\text{DIR}}$	VSS or Open	VDD	1600	100



PM2005M/P

COMPONENT LIST

Items	Part Type	Designator	Description
1	1 μ / 16v / No Polarity	C1, C2, C3	Capacitor Electrolytic Radial
2	220n / 63v	C4, C5	Capacitor Monolithic Ceramic
3	1 μ / 63v	C6	Capacitor Monolithic Ceramic
4	100n	C7	Capacitor Monolithic Ceramic
5	10 μ / 16v	C8, C9	Capacitor Tantalum
6	470 μ / 25V	C10, C11	Capacitor Electrolytic Radial
7	470n / 250VAC	C12, C13, C14	Capacitor Polyester
8	470 μ / 16V	C15	Capacitor Electrolytic Radial
9	1N4007	D1, D2, D3, D4, D5, D6	Rectifier Diode
10	47V	D7	47V Zener Diode
11	LED	L1, L2, L7	LED 3mm Diameter, Red
12	LED	L3, L4	LED 3mm Diameter, Yellow
13	LED	L5, L6	LED 3mm Diameter, Green
14	MOTOR	SK2	2 Pin Molex, Canter Square pin, Friction Lock
15	OPTO	SK4	2 Pin Molex, Canter Square pin, Friction Lock
16	Prog	SK3	5 Pin Molex, Canter Square pin, Friction Lock
17	2.7k	R1, R2, R3, R4, R5, R6	1/4 Watt, 1% Metal Film Resistor
18	24k	R7	1/4 Watt, 1% Metal Film Resistor
19	1M	R8, R9, R10	1/4 Watt, 1% Metal Film Resistor
20	22k	R11, R12, R13	1/4 Watt, 1% Metal Film Resistor
21	82k	R14, R16, R18, R20, R22, R24	1/4 Watt, 1% Metal Film Resistor
22	100k	R15, R17, R19, R21, R23, R25	1/4 Watt, 1% Metal Film Resistor
23	3R6	R26, R27, R28	1/4 Watt, 1% Metal Film Resistor
24	47R / 2 Watt	R29, R30, R31	2 Watt, 1% Wire Wound Resistor
25	470R / 1 Watt	R32, R33	1 Watt, 1% Wire Wound Resistor
26	680R	R34, R35, R36, R37	1/4 Watt, 5%, Carbon Resistor
27	Pot 10k	P1, P2, P3	Multi turn trim pot, Top adjust
28	MAINS	SK1	7 Pin Molex, Canter square pin, Friction Lock
29	Prog	J8	5 Pin Header
30	S10 / 275	Z1, Z2, Z3	Metal Oxide Varistor
31	SA2005M or SA2005P	U1	24 Pin IC Socket, Tulip Type
32	24C01A	U2	1k IIC EEPROM / Not fitted. For use with SA2005P
33	TL431	U3, U4	TO -92 Package
34	TZ76	CT1, CT2, CT3	1:2500, Current Transformer



PM2005M/P

sames

PCB LAYOUT

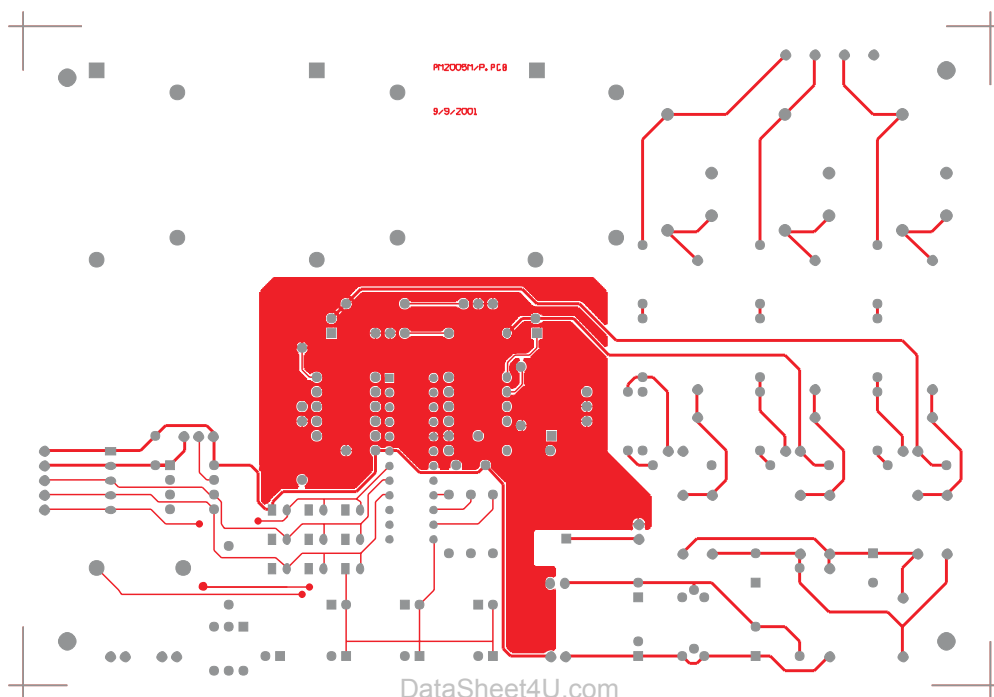

Figure 6: PM2005M Top PCB layout

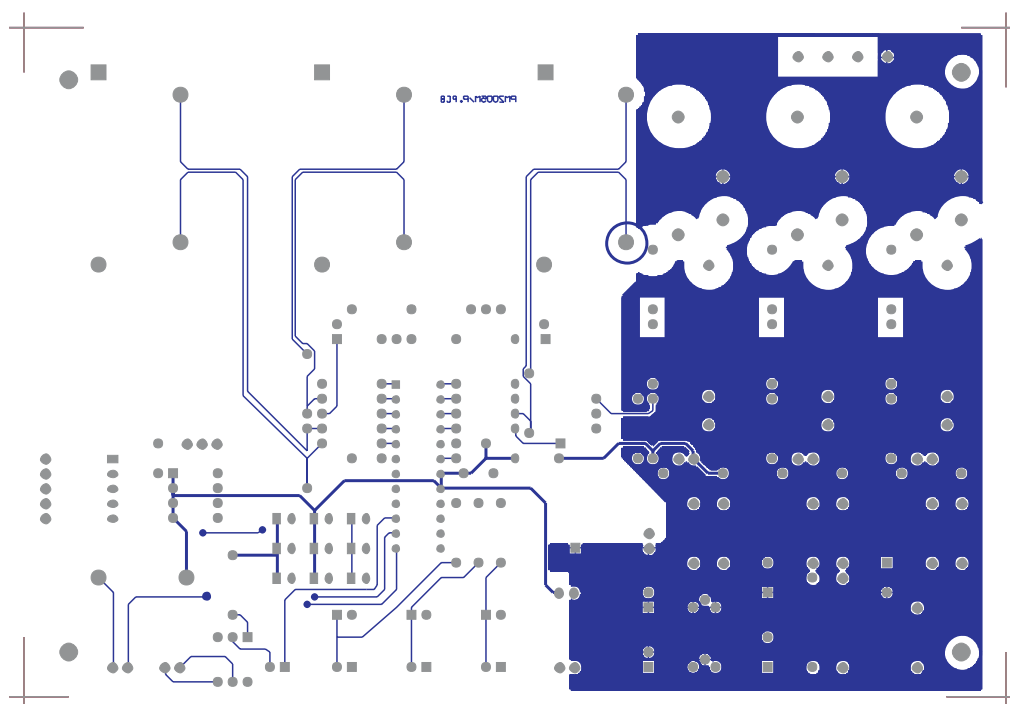

Figure 7: PM2005M Bottom PCB layout



PM2005M/P

sames

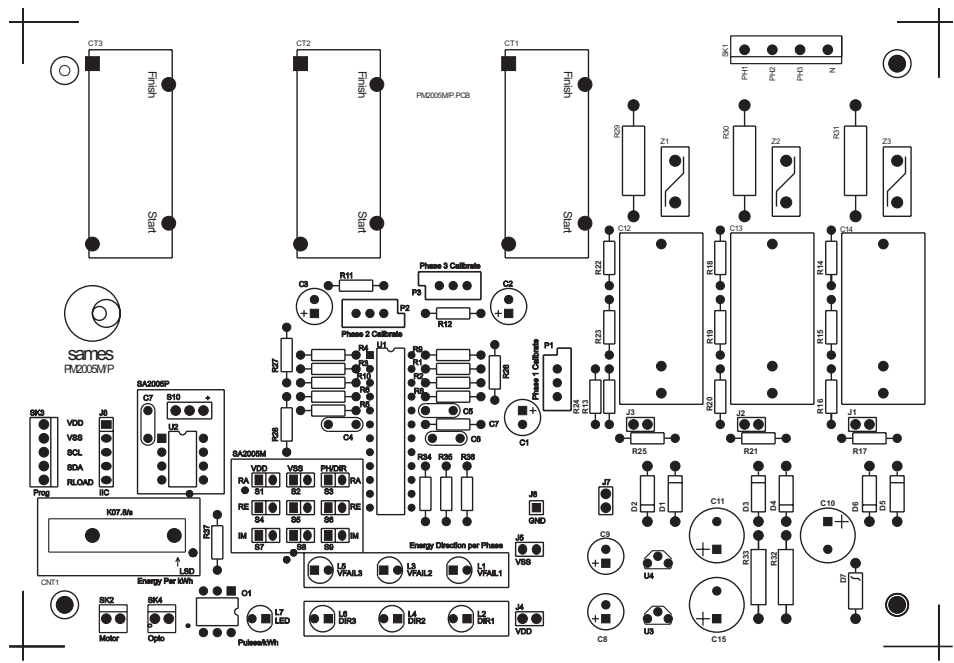

Figure 8: PM2005M Silkscreen PCB layout

et4U.com

DataSheet4U.com

DataShee

**PM2005M/P****sames****DISCLAIMER:**

The information contained in this document is confidential and proprietary to South African Micro-Electronic Systems (Pty) Ltd ("SAMES") and may not be copied or disclosed to a third party, in whole or in part, without the express written consent of SAMES. The information contained herein is current as of the date of publication; however, delivery of this document shall not under any circumstances create any implication that the information contained herein is correct as of any time subsequent to such date. SAMES does not undertake to inform any recipient of this document of any changes in the information contained herein, and SAMES expressly reserves the right to make changes in such information, without notification, even if such changes would render information contained herein inaccurate or incomplete. SAMES makes no representation or warranty that any circuit designed by reference to the information contained herein, will function without errors and as intended by the designer.

Any sales or technical questions may be posted to our e-mail address below:
energy@sames.co.za

For the latest updates on datasheets, please visit our web site:
<http://www.sames.co.za>

**SOUTH AFRICAN MICRO-ELECTRONIC
SYSTEMS (PTY) LTD**

Tel: (012) 333-6021
Tel: Int +27 12 333-6021
Fax: (012) 333-8071
Fax: Int +27 12 333-8071

**P O BOX 15888
LYNN EAST
0039
REPUBLIC OF SOUTH AFRICA**

**33 ELAND STREET
KOEDOESPOORT INDUSTRIAL AREA
PRETORIA
REPUBLIC OF SOUTH AFRICA**