

## Miniature Basic Switch

# V

### Reliable Basic Switches in a Wide Variation

- Wide variation of best-selling microswitches with switching currents of 10 to 21 A.
- Can be used for interrupting current when doors are opened or closed.
- Available in two types of cases: thermoplastic resin and thermosetting resin.

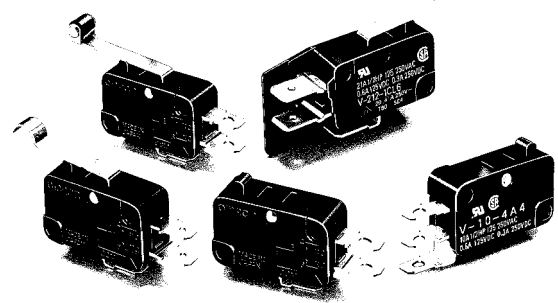

### Ordering Information

#### ■ Model Number Legend

V-□□□-□□□□-□  
 1 2 3 4 5 6 7 8

#### 1. Ratings

- 21: 21 A at 250 VAC
- 16: 16 A at 250 VAC
- 15: 15 A at 250 VAC
- 11: 11 A at 250 VAC
- 10: 10 A at 250 VAC

#### 2. Contact Gap

- None: 1 mm (F gap)
- G: 0.5 mm (G gap) (for remodelling)

#### 3. Actuator

- None: Pin plunger
- 1: Short hinge lever
- 2: Hinge lever
- 3: Long hinge lever
- 4: Simulated roller lever
- 5: Short hinge roller lever
- 6: Hinge roller lever

#### 4. Contact Form

- 1: SPDT (COM bottom terminal, double-throw)
- 2: SPST-NC (COM bottom terminal, normally closed)
- 3: SPST-NO (COM bottom terminal, normally open)
- 4: SPDT (COM side terminal, double-throw)
- 5: SPST-NC (COM side terminal, normally closed)
- 6: SPST-NO (COM side terminal, normally open)

#### 5. Terminals

- A: Solder terminals
- C2: Quick-connect terminals (#187)
- C: Quick-connect terminals (#250)
- B: Screw terminals

#### 6. Barrier (Models with Thermoplastic Case Only)

- None: Without barrier
- R: Right-hand barrier
- L: Left-hand barrier

#### 7. Maximum Operating Force

- 6: 3.92 N {400 gf}
- 5: 1.96 N {200 gf}
- 4: 0.98 N {100 gf}

**Note:** These values are for the pin plunger models.

#### 8. Special Purpose (Models with Thermosetting Case Only)

- T: Heat-resistive

## Available Combinations

Terminal				Thermoplastic case			Thermosetting case						
				Model	V-21	V-16	V-11	V-15		V-10			
				Rated current	21 A	16 A		15 A		10 A			
COM terminal position	Insulation barrier	Heat resistance	Terminal symbol	OF	3.92 N {400 gf}	3.92 N {400 gf}	1.96 N {200 gf}	0.98 N {100 gf}	3.92 N {400 gf}	1.96 N {200 gf}	1.96 N {200 gf}	0.98 N {100 gf}	
Bottom	No	Standard (80°C)	Solder terminals (A)	---	○	●	●	○	●	●	●	●	
			Quick-connect terminals (#187) (C2)	---	○	●	●	○	●	●	●	●	
			Quick-connect terminals (#250) (C)	●	○	●	●	○	○	○	○	○	○
			Screw terminals (B)	---	---	---	○ (1.96 N)	○	●	●	●	●	
		Heat resistant (150°C)	Solder terminals (A)	---	---	---	---	○	●	●	●	●	●
			Quick-connect terminals (#187) (C2)	---	---	---	---	○	○	○	○	○	○
	Yes	Standard (80°C)	Solder terminals (A)	---	○	●	---	---	---	---	---	---	---
			Quick-connect terminals (#187) (C2)	---	○	●	---	---	---	---	---	---	---
			Quick-connect terminals (#250) (C)	●	○	●	---	---	---	---	---	---	---
		Heat resistant (150°C)	Solder terminals (A)	---	---	---	---	---	---	---	---	---	---
			Quick-connect terminals (#187) (C2)	---	---	---	---	---	---	---	---	---	---
			Quick-connect terminals (#250) (C)	---	---	---	---	---	---	---	---	---	---
Side	No	Standard (80°C)	Solder terminals (A)	---	---	---	---	○	●	●	●	●	
			Quick-connect terminals (#187) (C2)	---	---	---	---	○	○	○	○	○	
			Quick-connect terminals (#250) (C)	○	---	---	---	---	---	---	---	---	---

Note: 1. ●: Standard  
○: Semi-standard







2. Consult your OMRON sales representative for specific models with standard approvals.

## List of Models

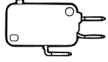
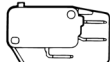
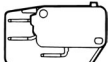
### General-purpose Models







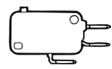
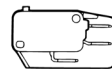
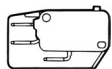

(Only combinations with standard terminals are shown.)

#### Thermoplastic Case



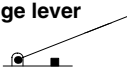



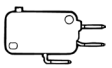

Actuator	COM terminal position	Contact form	Terminals (see note)	21 A (OF: 3.92 N {400 gf})		
				Without barrier	Right-hand barrier	Left-hand barrier
Pin plunger 	Bottom	SPDT	C			
				V-21-1C6	V-21-1CR6	V-21-1CL6
				V-21-2C6	V-21-2CR6	V-21-2CL6
Short hinge lever 		SPDT		V-21-3C6	V-21-3CR6	V-21-3CL6
				V-211-1C6	V-211-1CR6	V-211-1CL6
				V-212-1C6	V-212-1CR6	V-212-1CL6
Hinge lever 		V-213-1C6		V-213-1CR6	V-213-1CL6	
		V-214-1C6		V-214-1CR6	V-214-1CL6	
Long hinge lever 		V-215-1C6		V-215-1CR6	V-215-1CL6	
	V-216-1C6	V-216-1CR6	V-216-1CL6			
Simulated roller lever 						
Short hinge roller lever 						
Hinge roller lever 						

Note: C: Quick-connect terminals (#250)

www.DataSheet4U.com

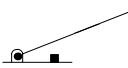





Actuator	COM terminal position	Contact form	Terminals (see note)	16 A (OF: 1.96 N {200 gf})		
				Without barrier 	Right-hand barrier 	Left-hand barrier 
Pin plunger 	Bottom	SPDT	A	V-16-1A5	V-16-1AR5	V-16-1AL5
			C2	V-16-1C25	V-16-1C2R5	V-16-1C2L5
			C	V-16-1C5	---	---
		SPST-NC	A	V-16-2A5	V-16-2AR5	V-16-2AL5
			C2	V-16-2C25	V-16-2C2R5	V-16-2C2L5
			C	V-16-2C5	---	---
		SPST-NO	A	V-16-3A5	V-16-3AR5	V-16-3AL5
			C2	V-16-3C25	V-16-3C2R5	V-16-3C2L5
			C	V-16-3C5	---	---
Short hinge lever 	Bottom	SPDT	A	V-161-1A5	V-161-1AR5	V-161-1AL5
C2			V-161-1C25	V-161-1C2R5	V-161-1C2L5	
C			V-161-1C5	---	---	
Hinge lever 		A	V-162-1A5	V-162-1AR5	V-162-1AL5	
		C2	V-162-1C25	V-162-1C2R5	V-162-1C2L5	
		C	V-162-1C5	---	---	
Long hinge lever 		A	V-163-1A5	V-163-1AR5	V-163-1AL5	
		C2	V-163-1C25	V-163-1C2R5	V-163-1C2L5	
		C	V-163-1C5	---	---	
Simulated roller lever 		A	V-164-1A5	V-164-1AR5	V-164-1AL5	
		C2	V-164-1C25	V-164-1C2R5	V-164-1C2L5	
		C	V-164-1C5	---	---	
Short hinge roller lever 		A	V-165-1A5	V-165-1AR5	V-165-1AL5	
		C2	V-165-1C25	V-165-1C2R5	V-165-1C2L5	
		C	V-165-1C5	---	---	
Hinge roller lever 		A	V-166-1A5	V-166-1AR5	V-166-1AL5	
		C2	V-166-1C25	V-166-1C2R5	V-166-1C2L5	
		C	V-166-1C5	---	---	

**Note:** A: Solder terminals  
 C2: Quick-connect terminals (#187)  
 C: Quick-connect terminals (#250)

Actuator	COM terminal position	Contact form	Terminals (see note)	11 A (OF: 0.98 N {100 gf})
				Without barrier 
<b>Pin plunger</b> 	Bottom	SPDT	A	V-11-1A4
			C2	V-11-1C24
			C	V-11-1C4
<b>Short hinge lever</b> 			A	V-111-1A4
			C2	V-111-1C24
			C	V-111-1C4
<b>Hinge lever</b> 			A	V-112-1A4
			C2	V-112-1C24
	C	V-112-1C4		
<b>Long hinge lever</b> 	A	V-113-1A4		
	C2	V-113-1C24		
	C	V-113-1C4		
<b>Simulated roller lever</b> 	A	V-114-1A4		
	C2	V-114-1C24		
	C	V-114-1C4		
<b>Short hinge roller lever</b> 	A	V-115-1A4		
	C2	V-115-1C24		
	C	V-115-1C4		
<b>Hinge roller lever</b> 	A	V-116-1A4		
	C2	V-116-1C24		
	C	V-116-1C4		

**Note:** A: Solder terminals  
C2: Quick-connect terminals (#187)  
C: Quick-connect terminals (#250)







Thermosetting Case  
www.DataSheet4U.com

Actuator	COM terminal position	Contact form	Terminals (see note 1)	15 A	10 A	
				OF: 1.96 N {200 gf}	OF: 1.96 N {200 gf}	OF: 0.98 N {100 gf}
<b>Pin plunger</b> 	Bottom	SPDT	A	V-15-1A5	V-10-1A5	V-10-1A4
			C2	V-15-1C25	V-10-1C25	V-10-1C24
			B	V-15-1B5	V-10-1B5	V-10-1B4
		SPST-NC	A	V-15-2A5	V-10-2A5	V-10-2A4
			C2	V-15-2C25	V-10-2C25	V-10-2C24
			B	V-15-2B5	V-10-2B5	V-10-2B4
		SPST-NO	A	V-15-3A5	V-10-3A5	V-10-3A4
			C2	V-15-3C25	V-10-3C25	V-10-3C24
			B	V-15-3B5	V-10-3B5	V-10-3B4
Side	SPDT	A	V-15-4A5	V-10-4A5	V-10-4A4	
		C2	V-15-5A5	V-10-5A5	V-10-5A4	
		B	V-15-6A5	V-10-6A5	V-10-6A4	
<b>Short hinge lever</b> 	Bottom	SPDT	A	V-151-1A5	V-101-1A5	V-101-1A4
			C2	V-151-1C25	V-101-1C25	V-101-1C24
			B	V-151-1B5	V-101-1B5	V-101-1B4
<b>Hinge lever</b> 			A	V-152-1A5	V-102-1A5	V-102-1A4
			C2	V-152-1C25	V-102-1C25	V-102-1C24
			B	V-152-1B5	V-102-1B5	V-102-1B4
<b>Long hinge lever</b> 			A	V-153-1A5	V-103-1A5	V-103-1A4
			C2	V-153-1C25	V-103-1C25	V-103-1C24
			B	V-153-1B5	V-103-1B5	V-103-1B4
<b>Simulated roller lever</b> 			A	V-154-1A5	V-104-1A5	V-104-1A4
			C2	V-154-1C25	V-104-1C25	V-104-1C24
			B	V-154-1B5	V-104-1B5	V-104-1B4
<b>Short hinge roller lever</b> 			A	V-155-1A5	V-105-1A5	V-105-1A4
			C2	V-155-1C25	V-105-1C25	V-105-1C24
			B	V-155-1B5	V-105-1B5	V-105-1B4
<b>Hinge roller lever</b> 			A	V-156-1A5	V-106-1A5	V-106-1A4
			C2	V-156-1C25	V-106-1C25	V-106-1C24
			B	V-156-1B5	V-106-1B5	V-106-1B4

- Note:** 1. A: Solder terminals  
 C2: Quick-connect terminals (#187)  
 B: Screw terminals
2. OF values shown in the table are for the pin plunger models.

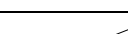
www.DataSheet4U.com

## Heat Resistant Models (Up to 150°C)

Actuator	COM terminal position	Contact form	Terminals	15 A	10 A
				OF: 1.96 N {200 gf}	OF: 0.98 N {100 gf}
Pin plunger 	Bottom	SPDT	Solder terminals (A)	V-15-1A5-T	V-10-1A4-T
Short hinge lever 				V-151-1A5-T	V-101-1A4-T
Hinge lever 				V-152-1A5-T	V-102-1A4-T
Long hinge lever 				V-153-1A5-T	V-103-1A4-T
Simulated roller lever 				V-154-1A5-T	V-104-1A4-T
Short hinge roller lever 				V-155-1A5-T	V-105-1A4-T
Hinge roller lever 				V-156-1A5-T	V-106-1A4-T

## ■ Barrier (V-21 and V-16 Models Only)

Right-hand Barrier

Left-hand Barrier

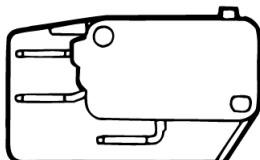
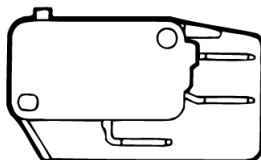

## Specifications

## ■ Ratings

Model	Item	Resistive load
	Rated voltage	
V-21	250 VAC	21 A
	125 VDC	0.6 A
	250 VDC	0.3 A
V-16	250 VAC	16 A
	125 VDC	0.6 A
	250 VDC	0.3 A
V-15	250 VAC	15 A
	125 VDC	0.6 A
	250 VDC	0.3 A
V-11	250 VAC	11 A
	125 VDC	0.6 A
	250 VDC	0.3 A
V-10	250 VAC	10 A
	125 VDC	0.6 A
	250 VDC	0.3 A

**Note:** The ratings values apply under the following test conditions:

Ambient temperature: 20±2°C

Ambient humidity: 65±5%

Operating frequency: 30 operations/min

www.elsa.com.cn ■ Switching Capacity per Load (Reference Values)

Model	Voltage	Non-inductive load				Inductive load			
		Resistive load		Lamp load		Inductive load		Motor load	
		NC	NO	NC	NO	NC	NO	NC	NO
V-21	250 VAC	21 A		3 A		12 A		4 A	
	8 VDC	21 A		5 A		12 A		7 A	
	30 VDC	14 A		5 A		12 A		5 A	
	125 VDC	0.6 A		0.1 A		0.6 A		0.1 A	
	250 VDC	0.3 A		0.05 A		0.3 A		0.05 A	
V-16	250 VAC	16 A		2 A		10 A		3 A	
	8 VDC	16 A		4 A		10 A		6 A	
	30 VDC	10 A		4 A		10 A		4 A	
	125 VDC	0.6 A		0.1 A		0.6 A		0.1 A	
	250 VDC	0.3 A		0.05 A		0.3 A		0.05 A	
V-15	250 VAC	15 A		2 A		10 A		3 A	
	8 VDC	15 A		4 A		10 A		6 A	
	30 VDC	10 A		4 A		10 A		4 A	
	125 VDC	0.6 A		0.1 A		0.6 A		0.1 A	
	250 VDC	0.3 A		0.05 A		0.3 A		0.05 A	
V-11	250 VAC	11 A		1.5 A		6 A		2 A	
	8 VDC	11 A		3 A		6 A		3 A	
	30 VDC	6 A		3 A		6 A		3 A	
	125 VDC	0.6 A		0.1 A		0.6 A		0.1 A	
	250 VDC	0.3 A		0.05 A		0.3 A		0.05 A	
V-10	250 VAC	10 A		1.5 A		6 A		2 A	
	8 VDC	10 A		3 A		6 A		3 A	
	30 VDC	6 A		3 A		6 A		3 A	
	125 VDC	0.6 A		0.1 A		0.6 A		0.1 A	
	250 VDC	0.3 A		0.05 A		0.3 A		0.05 A	

- Note:**
1. The above current values are the normal current values of models with a contact gap of 1 mm (gap F), which vary with the normal current values of models with a contact gap of 0.5 mm (gap G).
  2. Inductive load has a power factor of 0.4 min. (AC) and a time constant of 7 ms max. (DC).
  3. Lamp load has an inrush current of 10 times the steady-state current.
  4. Motor load has an inrush current of 6 times the steady-state current.

## ■ Characteristics

<b>Operating speed</b>	0.1 mm to 1 m/s (pin plunger models)
<b>Operating frequency</b>	Mechanical: 600 operations/min max. Electrical: 30 operations/min max.
<b>Insulation resistance</b>	100 MΩ min. (at 500 VDC)
<b>Contact resistance (initial value)</b>	15 mΩ max.
<b>Dielectric strength (see note 2)</b>	1,000 VAC, 50/60 Hz for 1 min between terminals of the same polarity V-21, V-16, and V-11 models: 2,000 VAC, 50/60 Hz for 1 min between current-carrying metal parts and ground, and between each terminal and non-current-carrying metal parts V-15 and V-10 models: 1,500 VAC, 50/60 Hz for 1 min between current-carrying metal parts and ground, and between each terminal and non-current-carrying metal parts
<b>Vibration resistance (see note 3)</b>	Malfunction: 10 to 55 Hz, 1.5-mm double amplitude
<b>Shock resistance (see note 3)</b>	Destruction: 1,000 m/s <sup>2</sup> {approx. 100G} max. Malfunction: V-21/V-16/V-15: 300 m/s <sup>2</sup> {approx. 30G} max. V-11/V-10: 200 m/s <sup>2</sup> {approx. 20G} max.
<b>Durability (see note 4)</b>	Mechanical: 50,000,000 operations min. (60 operations/min) Electrical: V-21/V-16/V-15: 100,000 operations min. (30 operations/min) (V-15 heat resistive: 20,000 operation min. (30 operations/min)) V-11/V-10: 300,000 operations min. (30 operations/min) (V-10 heat resistive: 50,000 operation min. (30 operations/min))
<b>Degree of protection</b>	IEC IP40
<b>Degree of protection against electric shock</b>	Class I
<b>Proof tracking index (PTI)</b>	175
<b>Ambient operating temperature</b>	-25°C to 80°C (at ambient humidity of 60% max.) (with no icing) -25°C to 150°C for heat-resistive model (at ambient humidity of 60% max.) (with no icing)
<b>Ambient operating humidity</b>	85% max. (for 5°C to 35°C)
<b>Weight</b>	Approx. 6.2 g (pin plunger models)

- Note:**
1. The data given above are initial values.
  2. The dielectric strength values shown in the table are for models with a Separator.
  3. For the pin plunger models, the above values apply for use at both the free position and total travel position. For the lever models, they apply at the total travel position.
  4. For testing conditions, contact your OMRON sales representative.

## ■ Approved Standards

Consult your OMRON sales representative for specific models with standard approvals.

### UL1054 (File No. E41515)/CSA C22.2 No. 55 (File NO. IR21642)

Rated voltage	V-21	V-16	V-15	V-11	V-10
125 VAC	21 A, 1/2 HP	16 A, 1/2 HP	15 A, 1/2 HP	11 A, 1/3 HP	10 A, 1/3 HP
250 VAC					
125 VDC	0.6 A	0.6 A	0.6 A	0.6 A	0.6 A
250 VDC	0.3 A	0.3 A	0.3 A	0.3 A	0.3 A

### EN61058-01 (File No. 129608, VDE approval)

Rated voltage	V-21	V-16	V-11
250 VAC	20 (4) A	16 (4) A	11 (3) A

Testing conditions: 5E4 (50,000 operations), T105 (0°C to 105°C)

### EN61058-1 (File No. T9451451, TÜV Rheinland approval)

Rated voltage	V-15	V-10
250 VAC	15 A	10 A
250 VDC	0.3 A	0.3 A

Testing conditions: 5E4 (50,000 operations), T85 (0°C to 85°C)



www.data-sheet.com ■ Contact Specifications

Item		V-21	V-16	V-15	V-11	V-10
Contact	Specification	Rivet				
	Material	Silver alloy			Silver	
	Gap (standard value)	1 mm (F gap) or 0.5 mm (G gap)				
Inrush current	NC	50 A max.	40 A max.	36 A max.	24 A max.	
	NO					
Minimum applicable load		160 mA at 5 VDC				

■ Contact Form

SPDT

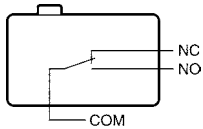

SPST-NC

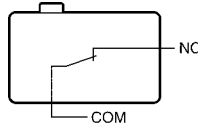

SPST-NO

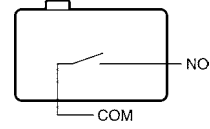

Engineering Data (Reference Values)

**Mechanical Durability (Pin Plunger Models)**

V-21/-16/-15/-10

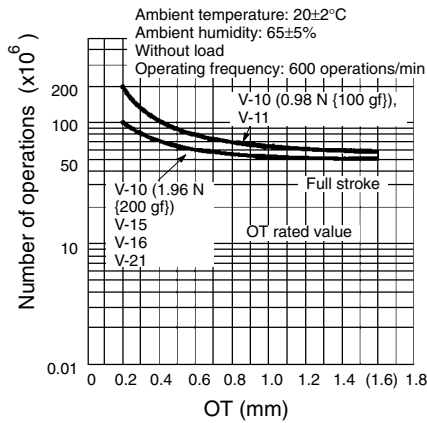

**Electrical Durability (Pin Plunger Models)**

V-21/-16/-15

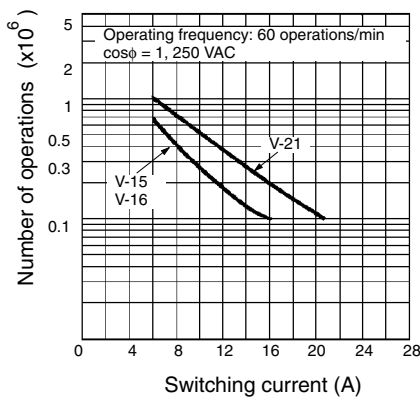

V-11/-10

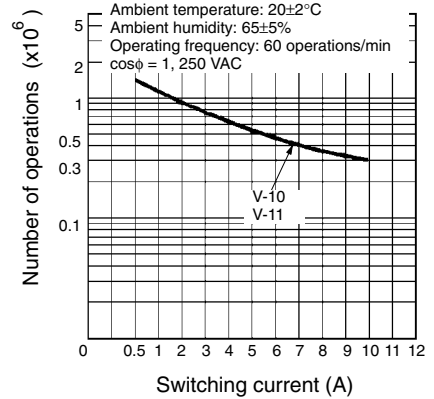

www.DataSheet4U.com **Dimensions**

■ **Terminals**

- Note:**
1. All units are in millimeters unless otherwise indicated.
  2. The following is for the SPDT contact specifications. Two terminals will be available for SPST-NO or SPST-NC contact specifications. For terminal positions, refer to *Contact Form* on page 118.
  3. Right-angle PCB terminal type is available  
 D5 type: Pins at right angles, to the right.  
 D6 type: Pins at right angles, to the left.  
 Drawings will be provided if requested.

Terminal type	Solder terminals (A)	Quick-connect Terminals (#187) (C2)	Quick-connect Terminals (#250) (C)	Screw Terminals (B)
COM bottom position	<p>t = 0.5 Three, solder terminals</p>	<p>t = 0.5 Three, quick-connect terminals (#187)</p>	<p>t = 0.8 Three, quick-connect terminals (#250)</p>	<p>Three, #M3 × 0.5 × 3.2 Phillips screw washer t = 0.8 (7)</p>
COM side position				---
Terminal dimensions	<p>2.4 dia. 1.6 dia. <b>Note:</b> Indicates the length to the center of the 1.6-dia. holes</p>	<p>1.6-dia. terminal hole</p>	<p>1.65-dia. terminal hole</p>	---

■ **Mounting Holes**

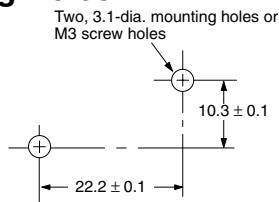

www.automation-direct.com ■ Dimensions and Operating Characteristics

- Note:**
1. All units are in millimeters unless otherwise indicated.
  2. Unless otherwise specified, a tolerance of  $\pm 0.4$  mm applies to all dimensions.
  3. The following illustrations and drawings are for quick-connect terminals (#250) (terminals C). V models with a switching current of 16 A or 11 A incorporates terminals A and C2. These models are different from #250 models in terminal size only. Terminals A, C2, and side common terminals are omitted from the following drawings. Refer to *Kinds of Terminals* on page 119 for these terminals.
  4. The □ in the model number is for the terminal code.
  5. The operating characteristics are for operation in the A direction (▼).

**Pin Plunger Models**

(Without Barrier)

- V-21-1□6
- V-16-1□5
- V-11-1□4

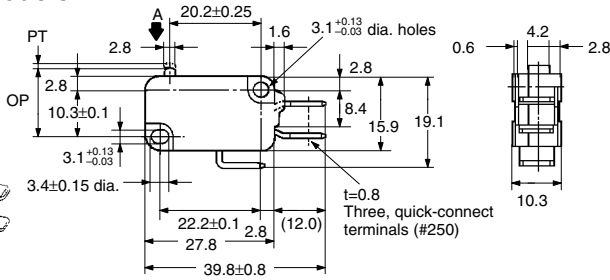
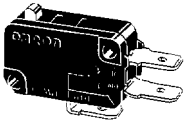

Model	V-21-1□6	V-16-1□5
OF max.	3.92 N {400 gf}	1.96 N {200 gf}
RF min.	0.78 N {80 gf}	0.49 N {50 gf}
PT max.	1.2 mm	
OT min.	1.0 mm	
MD max.	0.4 mm	
OP	14.7±0.4 mm	

(With Right-hand Barrier)

- V-21-1□R6
- V-16-1□R5

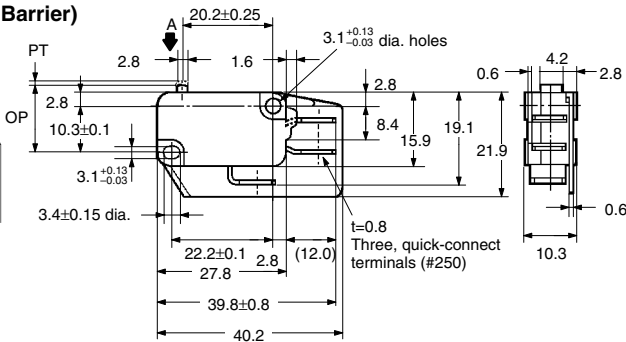
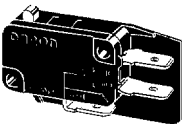

(With Left-hand Barrier)

- V-21-1□L6
- V-16-1□L5

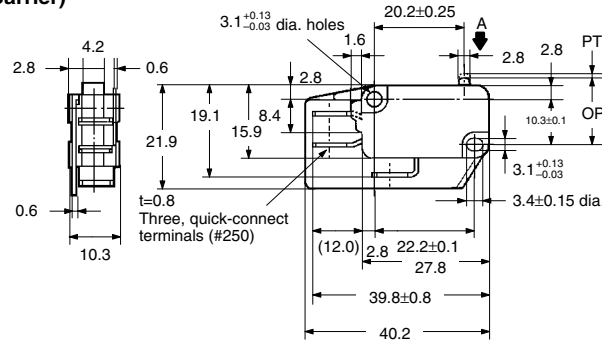

Model	V-11-1□4	V-11-1□5
OF max.	0.98 N {100 gf}	1.96 N {200 gf}
RF min.	0.20 N {20 gf}	0.49 N {50 gf}
PT max.	1.2 mm	
OT min.	1.0 mm	
MD max.	0.4 mm	
OP	14.7±0.4 mm	

www.DataSheet4U.com

### Short Hinge Lever Models

- V-211-1□6
- V-161-1□5
- V-111-1□4

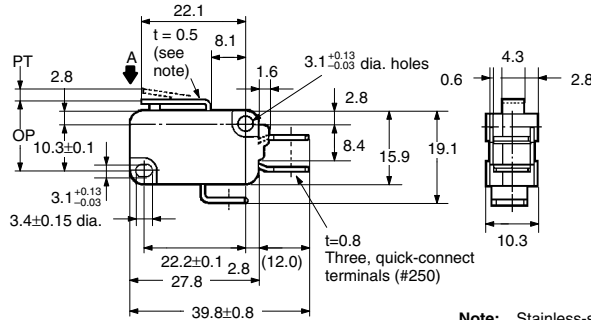
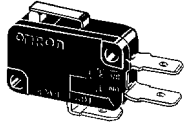

Note: Stainless-steel lever

Model	V-211-1□6	V-161-1□5
OF max.	3.92 N {400 gf}	1.96 N {200 gf}
RF min.	0.49 N {50 gf}	0.49 N {50 gf}
PT max.	1.6 mm	
OT min.	0.8 mm	
MD max.	0.6 mm	
OP	15.2±0.5 mm	

Model	V-111-1□4
OF max.	0.98 N {100 gf}
RF min.	0.15 N {15 gf}
PT max.	1.6 mm
OT min.	0.8 mm
MD max.	0.6 mm
OP	15.2±0.5 mm

### Hinge Lever Models

- V-212-1□6
- V-162-1□5
- V-112-1□4

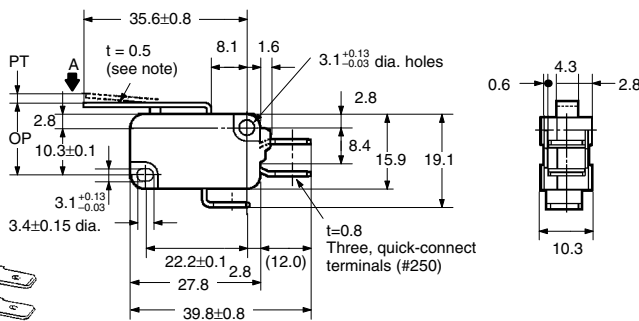
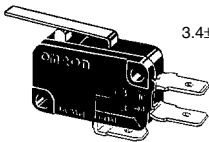

Note: Stainless-steel lever

Model	V-212-1□6	V-162-1□5
OF max.	2.45 N {250 gf}	1.23 N {125 gf}
RF min.	0.25 N {25 gf}	0.14 N {14 gf}
PT max.	4.0 mm	
OT min.	1.6 mm	
MD max.	1.5 mm	
OP	15.2±1.2 mm	

Model	V-112-1□4
OF max.	0.59 N {60 gf}
RF min.	0.06 N {6 gf}
PT max.	4.0 mm
OT min.	1.6 mm
MD max.	1.5 mm
OP	15.2±1.2 mm

### Long Hinge Lever Models

- V-213-1□6
- V-163-1□5
- V-113-1□4

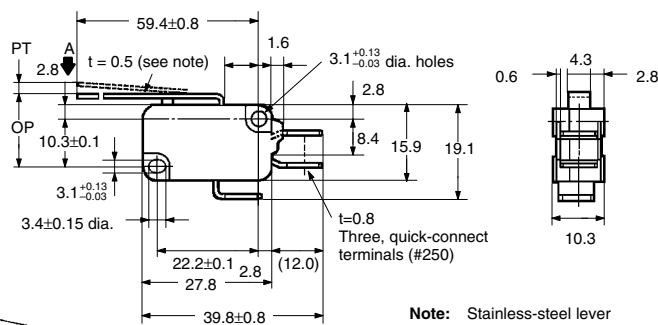
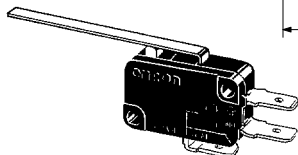

Note: Stainless-steel lever

Model	V-213-1□6	V-163-1□5
OF max.	1.27 N {130 gf}	0.69 N {70 gf}
RF min.	0.12 N {12 gf}	0.06 N {6 gf}
PT max.	9.0 mm	
OT min.	2.0 mm	
MD max.	2.8 mm	
OP	15.2 <sup>+2.6</sup> <sub>-3.2</sub> mm	

Model	V-113-1□4
OF max.	0.34 N {35 gf}
RF min.	---
PT max.	9.0 mm
OT min.	3.2 mm
MD max.	2.8 mm
OP	15.2±2.6 mm

**Simulated Roller Lever Models**

V-214-1□6  
V-164-1□5  
V-114-1□4

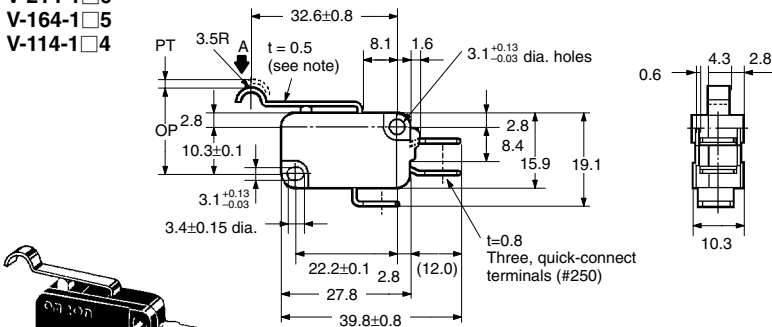

Note: Stainless-steel lever

Model	V-214-1□6	V-164-1□5
OF max.	2.45 N {250 gf}	1.23 N {125 gf}
RF min.	0.25 N {25 gf}	0.14 N {14 gf}
PT max.	4.0 mm	
OT min.	1.6 mm	
MD max.	1.5 mm	
OP	18.7±1.2 mm	

Model	V-114-1□4
OF max.	0.59 N {60 gf}
RF min.	0.06 N {6 gf}
PT max.	4.0 mm
OT min.	1.6 mm
MD max.	1.5 mm
OP	18.7±1.2 mm

**Short Hinge Roller Lever Models**

V-215-1□6  
V-165-1□5  
V-115-1□4

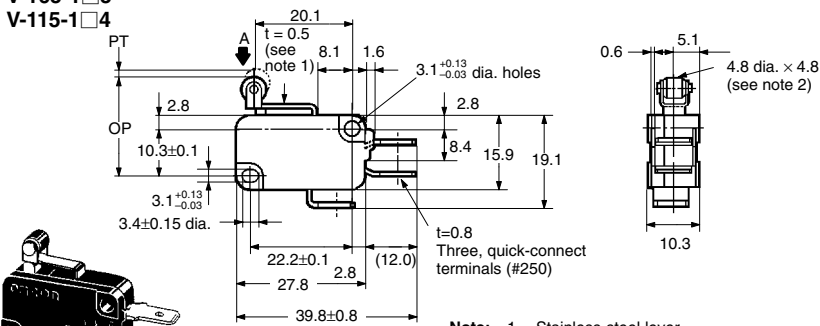

Note: 1. Stainless-steel lever  
2. Oilless polyacetal resin roller

Model	V-215-1□6	V-165-1□5
OF max.	4.71 N {480 gf}	2.35 N {240 gf}
RF min.	0.49 N {50 gf}	0.49 N {50 gf}
PT max.	1.6 mm	
OT min.	0.8 mm	
MD max.	0.6 mm	
OP	20.7±0.6 mm	

Model	V-115-1□4
OF max.	1.18 N {120 gf}
RF min.	0.15 N {15 gf}
PT max.	1.6 mm
OT min.	0.8 mm
MD max.	0.6 mm
OP	20.7±0.6 mm

**Hinge Roller Lever Models**

V-216-1□6  
V-166-1□5  
V-116-1□4

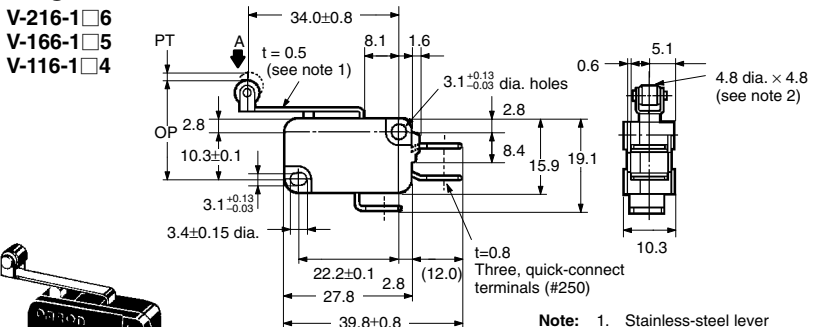

Note: 1. Stainless-steel lever  
2. Oilless polyacetal resin roller

Model	V-216-1□6	V-166-1□5
OF max.	2.45 N {250 gf}	1.23 N {125 gf}
RF min.	0.25 N {25 gf}	0.14 N {14 gf}
PT max.	4.0 mm	
OT min.	1.6 mm	
MD max.	1.5 mm	
OP	20.7±1.2 mm	

Model	V-116-1□4
OF max.	0.59 N {60 gf}
RF min.	0.06 N {6 gf}
PT max.	4.0 mm
OT min.	1.6 mm
MD max.	1.5 mm
OP	20.7±1.2 mm

## Thermosetting Case (V-15/-10 Models)

www.DataSheet4U.com

The following illustration and drawing are for solder and quick-connect terminals (#187) (terminals A). V models with a switching current of 15 A or 10 A incorporate terminals B or C2. These models are different from #187 models in terminal size only. Refer to *Terminals* on page 119 for these terminals.

### Pin Plunger Models

V-15-1□5  
V-10-1□5  
V-10-1□4

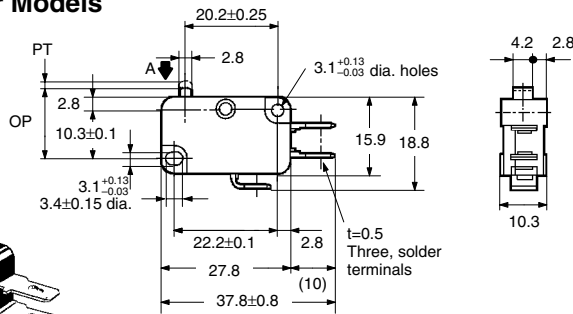
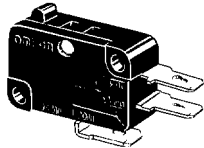

Model	V-15-1□5 V-10-1□5	V-10-1□4
OF max.	1.96 N {200 gf}	0.98 N {100 gf}
RF min.	0.49 N {50 gf}	0.20 N {20 gf}
PT max.	1.2 mm	
OT min.	1.0 mm	
MD max.	0.4 mm	
OP	14.7±0.4 mm	

### Short Hinge Lever Models

V-151-1□5  
V-101-1□5  
V-101-1□4

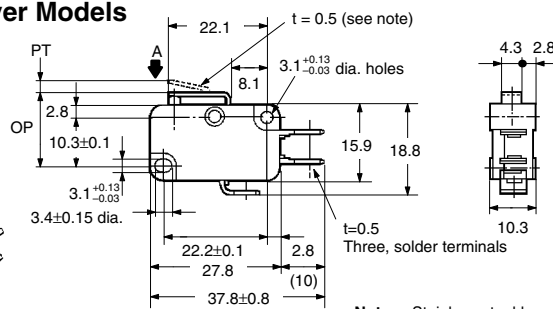
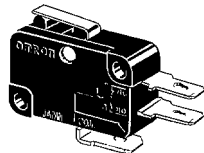

Note: Stainless-steel lever

Model	V-151-1□5 V-101-1□5	V-101-1□4
OF max.	1.96 N {200 gf}	0.98 N {100 gf}
RF min.	0.49 N {50 gf}	0.15 N {15 gf}
PT max.	1.6 mm	
OT min.	0.8 mm	
MD max.	0.6 mm	
OP	15.2±0.5 mm	

### Hinge Lever Models

V-152-1□5  
V-102-1□5  
V-102-1□4

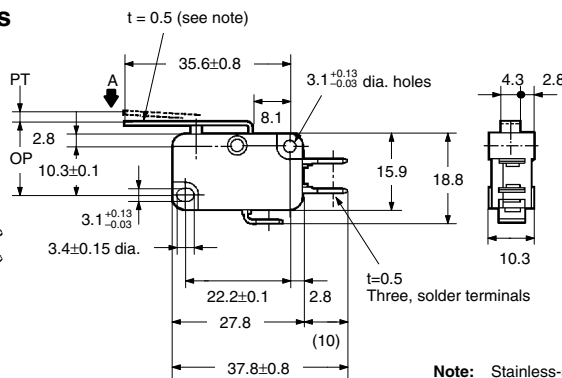
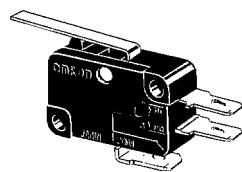

Note: Stainless-steel lever

Model	V-152-1□5 V-102-1□5	V-102-1□4
OF max.	1.23 N {125 gf}	0.59 N {60 gf}
RF min.	0.14 N {14 gf}	0.06 N {6 gf}
PT max.	4.0 mm	
OT min.	1.6 mm	
MD max.	1.5 mm	
OP	15.2±1.2 mm	

### Long Hinge Lever Models

V-153-1□5  
V-103-1□5  
V-103-1□4

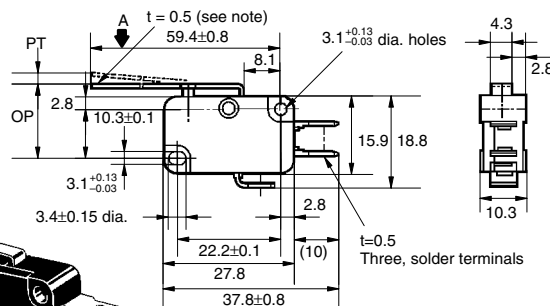
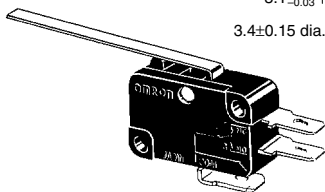

Note: Stainless-steel lever

Model	V-153-1□5 V-103-1□5	V-101-1□4
OF max.	0.69 N {70 gf}	0.34 N {35 gf}
RF min.	0.06 N {6 gf}	---
PT max.	9.0 mm	9.0 mm
OT min.	2.0 mm	3.2 mm
MD max.	2.8 mm	2.8 mm
OP	15.2 <sup>+2.6</sup> / <sub>-3.2</sub> mm	15.2±2.6 mm

**Simulated Roller Lever Models**

- V-154-1□5
- V-104-1□5
- V-104-1□4

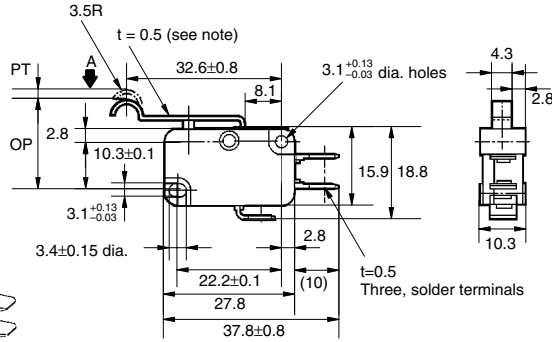
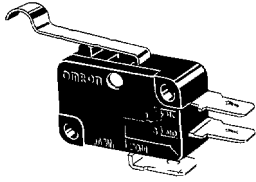

Note: Stainless-steel lever

Model	V-154-1□5 V-104-1□5	V-104-1□4
OF max.	1.23 N {125 gf}	0.59 N {60 gf}
RF min.	0.14 N {14 gf}	0.06 N {6 gf}
PT max.	4.0 mm	
OT min.	1.6 mm	
MD max.	1.5 mm	
OP	18.7±1.2 mm	

**Short Hinge Roller Lever Models**

- V-155-1□5
- V-105-1□5
- V-105-1□4

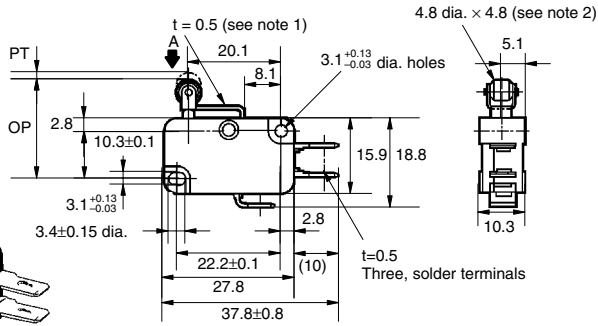
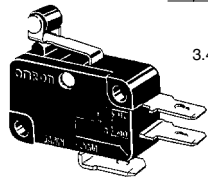

Note: 1. Stainless-steel lever  
2. Oilless polyacetal resin roller

Model	V-155-1□5 V-105-1□5	V-105-1□4
OF max.	2.35 N {240 gf}	1.18 N {120 gf}
RF min.	0.49 N {50 gf}	0.15 N {15 gf}
PT max.	1.6 mm	
OT min.	0.8 mm	
MD max.	0.6 mm	
OP	20.7±0.6 mm	

**Hinge Roller Lever Models**

- V-156-1□5
- V-106-1□5
- V-106-1□4

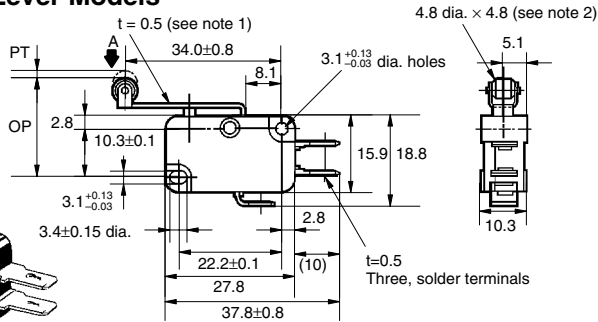
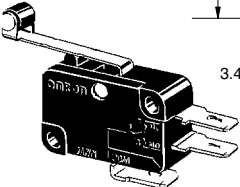

Note: 1. Stainless-steel lever  
2. Oilless polyacetal resin roller

Model	V-156-1□5 V-106-1□5	V-106-1□4
OF max.	1.23 N {125 gf}	0.59 N {60 gf}
RF min.	0.14 N {14 gf}	0.06 N {6 gf}
PT max.	4.0 mm	
OT min.	1.6 mm	
MD max.	1.5 mm	
OP	20.7±1.2 mm	

## Precautions

Refer to pages 26 to 31 for common precautions.

### ■ Correct Use

#### Specifications Approved by TÜV Rheinland According to EN61058-1

##### Appropriate Cable Size (mm<sup>2</sup>)

Model	Solder terminals	Screw terminals
V-10	0.75, 1.25, 2.0	0.75, 1.25
V-15	1.25, 2.0	1.25

Use M3 crimp terminals for connecting to the screw terminals.

Applicable M3 crimp terminals:

Daido Solderless Terminal Mfg. Co., Ltd.	F1.25-3
J.S.T. Mfg. Co., Ltd.	1.25 B3A

### Mounting

Use M3 mounting screws with plane washers or spring washers to securely mount the Switch. Tighten the screws to a torque of 0.39 to 0.59 N • m {4 to 6 kgf • cm}.

### Insulation Distance

According to EN61058-1, the minimum insulation thickness for this Switch should be 1.1 mm and minimum clearance distance between the terminal and mounting plate should be 1.9 mm. If the insulation distance cannot be provided in the product incorporating the Switch, either use a Switch with insulation barrier or use a Separator to ensure sufficient insulation distance. Refer to Separator on page 152.

### ■ Actuator (Sold Separately)

Various Actuators are available as shown on pages 152 to 155.

### ■ Connector (Sold Separately)

Refer to Terminal Connectors on page 282.

**ALL DIMENSIONS SHOWN ARE IN MILLIMETERS.**

To convert millimeters into inches, multiply by 0.03937. To convert grams into ounces, multiply by 0.03527.



Correct Use

No.	Area	No.	Item	Page
1	Using Switches			26
2	Selecting Correct Switch			
3	Electrical Conditions	1	Load	27
		2	Application of Switch to Electronic Circuits	
		3	Switches for Micro Loads	
		4	Contact Protective Circuit	
4	Mechanical Conditions	1	Operating Stroke Setting	28
		2	Switching Speed and Frequency	
		3	Operating Condition	
		4	Operating Method	
5	Mounting	1	Securing	29
		2	Terminal Connections	
		3	Soldering Precautions	
6	Operation and Storage Environment	1	Handling	30
		2	Operating Environment	
		3	Storage Environment	
7	Switch Trouble and Corrective Action			31

■ Using Switches

- When switches are actually used, unforeseen accidents may occur. Before using a switch, perform all possible testing in advance.
- Unless otherwise specified, ratings and performances given in this catalog are for standard test conditions (i.e., 15 to 35°C, 25% to 75% humidity, and 86 to 106 kPa atmospheric pressure). When performing testing in the actual application, always use the same conditions as will be used in actual usage conditions for both the load and the operating environment.
- Reference data provided in this catalog represents actual measurements from production samples in graph form. All reference data values are nominal.
- All ratings and performance values provided in this catalog are the results of a single test each rating and performance value therefore may not be met for composite conditions.

■ Selecting Correct Switch

Select an appropriate switch for the operating environment and load conditions.

- Use the *Selection Guide* to select a suitable switch for the rated current, operating load, actuator type, and operating environment.
- It is not recommended to use a switch for a large current to switch a micro current, in terms of contact reliability. Select a switch that is suitable for the current actually being switched.
- Use a sealed switch in environments subject to water, other liquids and excessive dirt or dust.

■ Electrical Conditions

Load

The switching capacity of a switch significantly differs depending on whether the switch is used to break an alternating current or a direct current. Be sure to check both the AC and DC ratings of a switch. The control capacity will drop drastically if it is a DC load. This is because a DC load, unlike an AC load, has no current zero cross point. Therefore, if an arc is generated, it may continue for a comparatively long time. Furthermore, the current direction is always the same, which results in contact relocation phenomena, and the contacts hold each other with ease and will not separate if the surfaces of the contacts are uneven.

If the load is inductive, counter-electromotive voltage will be generated. The higher the voltage is, the higher the generated energy is, which increase the abrasion of the contacts and contact relocation phenomena. Make sure to use a switch within the rated conditions.

If a switch is used for switching both micro and high-capacity loads, be sure to connect relays suitable to the loads.

The rated loads of a switch are according to the following conditions:

Inductive Load: A load having a minimum power factor of 0.4 (AC) or a maximum time constant of 7 ms (DC).

Lamp Load: A load having an inrush current ten times the steady-state current.

Motor Load: A load having an inrush current six times the steady-state current.

**Note:** It is important to know the time constant (L/R) of an inductive load in a DC circuit.

Inrush Current

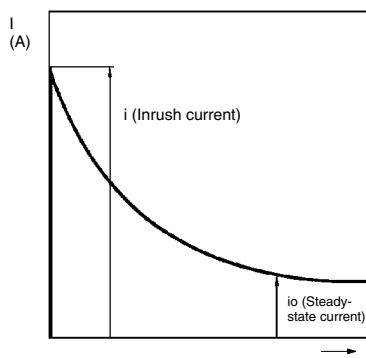

Application of Switch to Electronic Circuits

The Basic switch may have contact bouncing or chattering in switching, thus generating noise or pulse signals that may interfere the operation of electronic circuits or audio equipment. To prevent this, take the following countermeasures.

- Design the circuits so that they include appropriate CR circuits to absorb noise or pulse signals.
- Use switches with gold-plated contacts for micro loads, which are more resistive to environmental conditions.

Switches for Micro Loads

If a switch for a general load is used for switching a micro load, it may cause contact failures. Be sure to select a switch within the permissible range. Even if a switch for a micro load is used within the permissible range, the inrush current of the load may deteriorate the contacts, thus decreasing the durability of the switch. Therefore, if necessary, insert a proper contact protective circuit.

www.DataSheet4U.com

### Contact Protective Circuit

Apply a contact protective circuit (surge killer) to extend contact durability, prevent noise, and suppress the generation of carbide or nitric acid due to arc. Be sure to apply the contact protective circuit properly, otherwise an adverse effect may result. Some typical examples of contact protective circuit are described in the following table.

When a switch is used under high humidity, arcs resulting from certain types of load (e.g., inductive loads) will generate nitrous oxides and, with mater the nitrous oxides will become nitric acid, which will corrode internal metal parts and may cause malfunctions. Always use a contact protective circuit according to information provided in the following table when using a switch under circuit conditions of frequent switching and arcing.

The use of a contact protective circuit may delay the response time of the load.

#### Typical Examples of Contact Protective Circuits (Surge Killers)

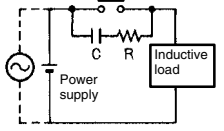
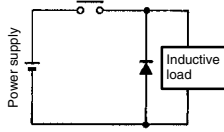
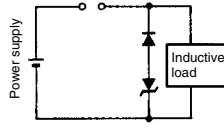
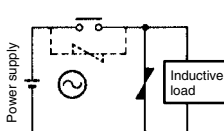
Circuit example	Applicable current		Feature	Element selection
	AC	DC		
CR circuit 	See note.	Yes	<b>Note:</b> When AC is switched, the load impedance must be lower than the C and R impedance.	C: 0.5 to 1 $\mu$ F per switching current (1 A) R: 0.5 to 1 $\Omega$ per switching voltage (1 V) The values may change according to the characteristics of the load.  The capacitor suppresses the spark discharge of current when the contacts are open. The resistor limits the inrush current when the contacts are closed again. Consider these roles of the capacitor and resistor and determine the ideal capacitance and resistance values from experimentation. Use a capacitor with a dielectric strength between 200 and 300 V. When AC is switched, make sure that the capacitor has no polarity. If, however, the ability to control arcs between contacts is a problem for high DC voltage, it may be more effective to connect a capacitor and resistor between the contacts across the load. Check the results by testing in the actual application.
		Yes		
Diode method 	No	Yes	Energy stored in the coil is changed into current by the diode connected in parallel to the load. Then the current flowing to the coil is consumed and Joule heat is generated by the resistance of the inductive load. The reset time delay in this method is longer than that of the CR method.	The diode must withstand a peak inverse voltage 10 times higher than the circuit voltage and a forward current as high as or higher than the load current.
Diode and Zener diode method 	No	Yes	This method will be effective if the reset time delay caused by the diode method is too long.	Zener voltage for a Zener diode must be about 1.2 times higher than the power source since the load may not work under some circumstances.
Varistor method 	Yes	Yes	This method makes use of constant-voltage characteristic of the varistor so that no high-voltage is imposed on the contacts. This method causes a reset time delay more or less. It is effective to connect varistor in parallel to the load when the supply voltage is 24 to 48 V and in parallel to the contacts when the supply voltage is 100 to 200 V.	Select the varistor so that the following condition is met for the cut voltage $V_c$ . For AC currents, the value must be multiplied by $\sqrt{2}$ . $V_c > (\text{Current Voltage} \times 1.5)$ If $V_c$ is set too high, however, the voltage cut for high voltages will no longer be effective, diminishing the effect.

Do not apply contact protective circuit as shown below.

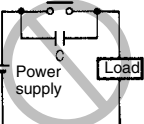
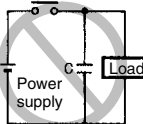
<b>Incorrect</b> 	This circuit effectively suppresses arcs when the contacts are OFF. The capacitance will be charged, however, when the contacts are OFF. Consequently, when the contacts are ON again, short-circuited current from the capacitance may cause contact weld.	<b>Incorrect</b> 	This circuit effectively suppresses arcs when the contacts are OFF. When the contacts are ON again, however, charge current flows to the capacitor, which may result in contact weld.
---	---	---	---

www.DataSheet4U.com

## Mechanical Conditions

### Operating Stroke Setting

The setting of stroke is very important for a switch to operate with high reliability.

The chart below shows the relationship among operating force, stroke, and contact force. To obtain high reliability from a switch, a switch actuator must be manipulated within an appropriate range of operating force.

Be sure to pay the utmost attention when mounting a switch.

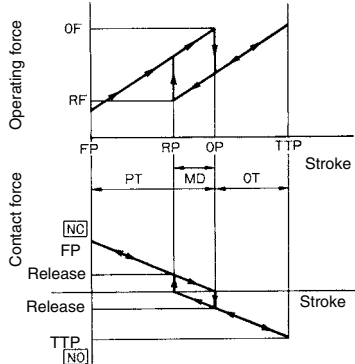

Make sure that the operating body is set so that the actuator should return to the free position when the operating body has moved if a switch is used to form a normally closed (NC) circuit. If a switch is used to form a normally open (NO) circuit, the operating body must move the switch actuator to the distance of 70% to 100% of the rated overtravel (OT) of the switch.

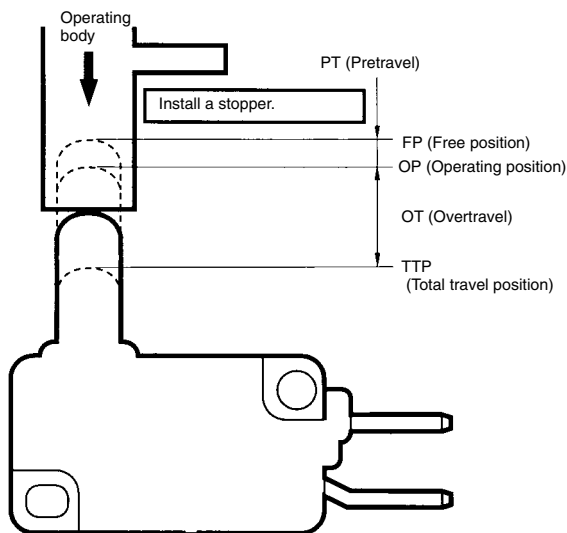

If stroke is set in the vicinity of the operating position (OP) or the releasing position (RP), contact force may become unstable. As a result, the switch cannot ensure high reliability. Furthermore, the switch may malfunction due to vibration or shock.

If stroke is set exceeding the total travel position (TTP), the moment of inertia of the operating body may damage the actuator or the switch itself, and the stress applied to the moving spring inside the switch will increase and then, the durability of the switch may be deteriorated.

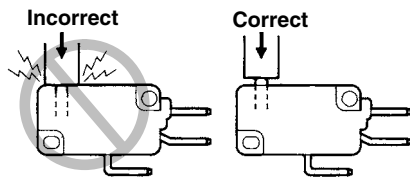

### Switching Speed and Frequency

The switching frequency and speed of a switch have a great influence on the performance of the switch. Pay attention to the following.

- If the actuator is operated too slowly, the switching operation may become unstable, causing contact failures or contact welding.
- If the actuator is operated too quickly, the switch may be damaged by shock.
- If the switching frequency is too high, the switching of the contacts cannot catch up with the operating speed of the actuator.
- If the operating frequency is extremely low (i.e., once a month or less frequent), a film may be generated on the surface of the contacts, which may cause contact failures.

The permissible switching speed and switching frequency of a switch indicate the operational reliability of the switch. The durability of a switch is based on operation under specific conditions regarding the switching speed and switching frequency. The durability of a switch may not meet the durability due to conditions even if the switch is operated within the permissible switching speed and frequency ranges. Test a switch sample under the actual conditions to ascertain its durability.

### Operating Condition

Do not leave a switch with the actuator depressed for a long time, otherwise the parts of the switch may soon deteriorate and the changes of its characteristics operating may result.

### Operating Method

The operating method has a great influence on the performance of a switch. Consider the following before operating a switch.

- Design the operating body (i.e., cam or dog) so that it will operate the actuator smoothly. If the actuator snaps backwards quickly or receives shock due to the shape of the operating body, its durability may be deteriorated.

Incorrect

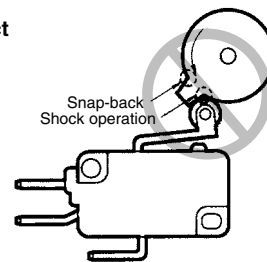

Correct

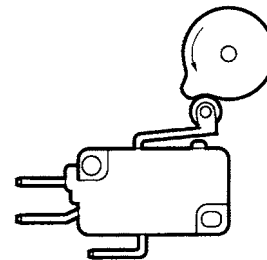

www.DataSheet4U.com

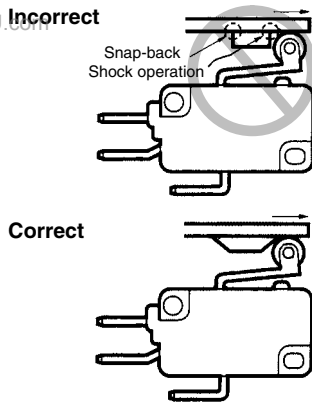

- Make sure that no improper force is applied to the actuator, otherwise the actuator may incur local abrasion. As a result, the actuator may become damaged or its durability may be deteriorated.

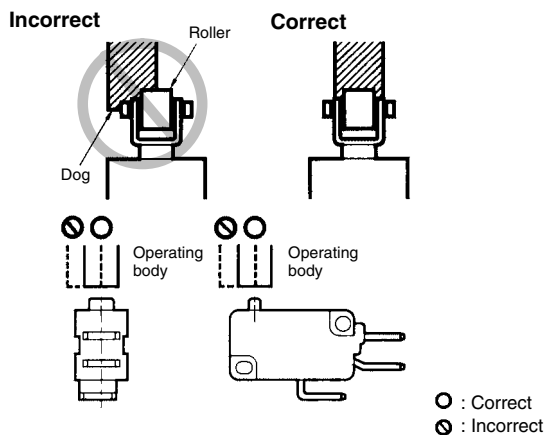

- Make sure that the operating body moves in a direction where the actuator moves. If the actuator is a pin plunger type, make sure that the operating body presses the pin plunger vertically.
- Operate the actuator of a hinge roller lever or simulated hinge lever type in the direction shown below.

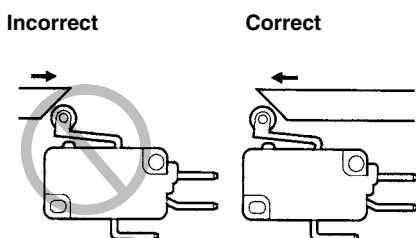

- Set the angle of the cam or dog ( $\theta$ ) for roller levers and similar actuators to the range between  $30^\circ$  and  $45^\circ$ . If the angle is too large, an abnormally large horizontal stress will be applied to the lever.

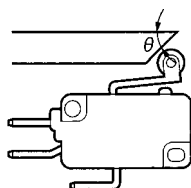

- Do not modify the actuator. If the actuator is modified, excessive external force may be applied to the internal switch mechanism, characteristics may change, and the switch may stop functioning.
- If an external actuator is used as an operating object, check the material and thickness of the lever to make sure that the force applied to the lever is within the permissible range.

■ Mounting

Securing

When mounting a switch, be sure to use the specified mounting screws and tighten the screws with flat washers or spring washers securely.

However, the switch housing may incur crack damage if it comes into contact with the spring washers directly. In that case make sure that the flat washers come into contact with the switch housing as shown below. Do not subject the switch to excessive shock or high-frequency vibrations when mounting (e.g., do not use an impact driver) as it may cause contacts stick or switch damage.

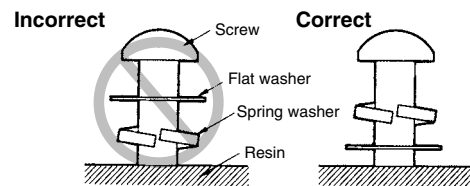

Do not modify the switch in any way, for example, by widening the mounting holes.

Locking Agent

If glue or locking agent is applied, make sure that it does not stick to the moving parts or intrude into the inside of the switch, otherwise the switch may have operating failure or contact failure. Some types of glue or locking agent may generate gas that has a bad influence on the switch. Pay the utmost attention when selecting glue or locking agent.

Wiring

Make sure that the lead wires are connected with no inappropriate pulling force.

Mounting Location

Be sure not to mount a switch in locations where the switch may be actuated by mistake.

Maintenance and Inspection

Make sure that a switch is mounted in locations that allow easy inspection or replacement of the switch.

Mounting Direction

When using a switch with a low operating force mounted with a long lever, make sure that the switch is mounted in the direction where the weight of the lever is not applied to the pushbutton directly, otherwise the switch may have releasing failures.

Terminal Connections

Solder Terminals

When soldering lead wires to a switch, make sure that the temperature of the iron tip is  $380^\circ\text{C}$  maximum. Improper soldering may cause abnormal heat radiation from the switch and the switch may burn.

Complete soldering within 5 seconds at  $350^\circ\text{C}$  or within 3 seconds at  $380^\circ\text{C}$ . If heat is applied for longer period of time, switch characteristics will be deteriorated, e.g., the case will melt and lead wire insulation will scorch.

Soldering conditions are even more strict for ultra subminiature switches. Refer to the *Precautions* for individual models for details.

Quick-Connect Terminals

Use the specified receptacles to connect to quick-connect terminals. Do not apply excessive force horizontally or vertically to the

www.DataSheet4U.com

terminals, otherwise the terminal may be deformed or the housing may be damaged.

**Wiring Work**

When wiring a switch, check the insulation distance between the switch and the mounting plate. If the insulation distance is insufficient, use an insulation guard or separator. Be particularly careful when mounting a switch to metal.

Use wire sizes suitable for the applied voltage and carrying current. Do not wire a switch while power is being supplied.

**Using Separators**

If providing sufficient insulation distance is a problem or there are metal components or copper wire near a switch, use a switch with an insulation guard or use a separator (order separately) to provide sufficient insulation distance.

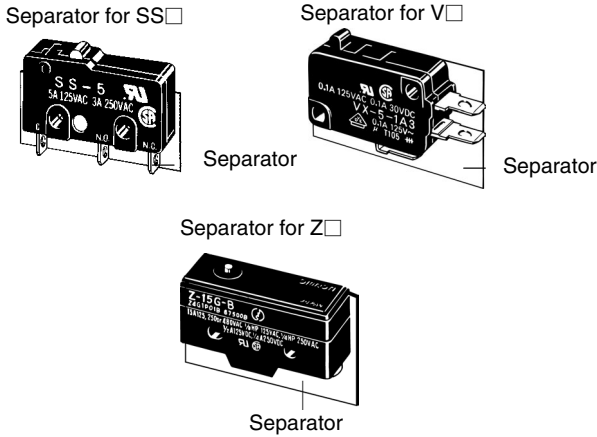

**Soldering Precautions**

When soldering by hand, place the terminal horizontal to the ground, use a soldering iron with a suitable heat capacity and a suitable amount of solder, and complete soldering quickly. Prevent flux from entering a switch by exhausting flux gas with an exhaust fan and by avoiding the contact of the tip of the soldering iron and the switch body. Flux gas inside a switch may cause contact failure. Do not apply any force to the terminal or wire immediately after soldering.

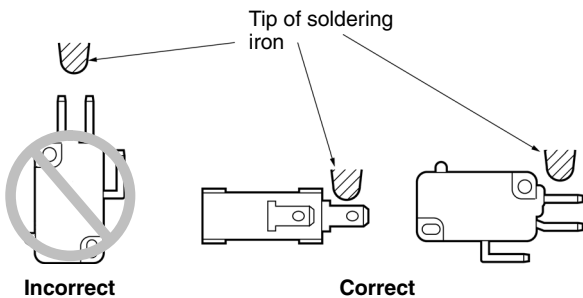

When soldering automatically, adjust the amount of solder so that flux does not float onto the top of PCB. If flux enters the switch, it can cause contact failure.

**Operation and Storage Environment Handling**

Do not apply oil, grease, or other lubricants to the sliding parts of a switch. The intrusion of oil, grease, or other lubricants into the internal part may cause operating failure or contact failure.

**Operating Environment**

A general switch is not water-resistant. Protect the switch appropriately when using the switch in places with water or oil spray.

Do not use a switch under the condition where vibration or shock is continuously applied to the switch. If continuous vibration or shock is applied to a switch, contact failure, malfunction, or decrease in durability may be caused by abrasive powder generated from the internal parts. If excessive vibration or shock is applied to a switch, the contacts may malfunction, stick, or be damaged.

Mount a switch in the location where vibration and shock is not applied to the switch and in the direction where they do not resonate.

Do not use a switch in the atmosphere of corrosive gas, such as sulfuric gas (H<sub>2</sub>S or SO<sub>2</sub>), ammonium gas (NH<sub>3</sub>), nitric gas (HNO<sub>3</sub>), or chlorine gas (Cl<sub>2</sub>), or in the atmosphere of high temperature and humidity. Otherwise, contact failure or corrosion damage may result.

If a switch is used in the atmosphere of silicon gas, arc energy may attract silicon dioxide (SiO<sub>2</sub>) to the contacts and contact failure may result. If there is silicon oil, silicon sealant, a wire covered with silicon, or any other silicon-based product near the switch, attach a contact protective circuit to suppress the arcing of the switch or eliminate the source of silicon gas generation. Even for a sealed switch, it may not be possible to prevent all of the gas from penetrating the seal rubber, and contact failure may result.

Be sure to use a switch at a temperature and humidity within the specified ranges. If a switch is exposed to radical temperature changes or intense heat, the characteristics of the switch may change. Separate the switch as far as possible from sources of heat to eliminate the influence.

**Storage Environment**

When storing a switch, consider countermeasures (e.g., storing in a plastic bag) to prevent discoloration resulting from sulfidization of terminals (silver-plated). Make sure that the location is free of corrosive gas or dust with no high temperature or humidity. It is recommended that a switch be inspected before use if it is stored for three months or more after the production, depending on the location.

## www.DataSheet4U.com Switch Trouble and Corrective Action

Type	Location of failure	Failure	Possible cause	Corrective action
Failures related to electrical characteristics	Contact	Contact failure	Dust and dirt on the contacts.	Remove the cause of the problem, place the switch in a box, or use a sealed switch.
			Water or other liquid has penetrated into a switch.	
			Chemical substances have been generated on the contact surface due to the atmosphere containing chemical corrosive gas.	Use a switch having contacts with high environmental resistivity (such as gold or alloy contacts).
		Chemical substances have been generated on the contact surface when the switch switches a very low load.		
		Solder flux has penetrated into the switch.	Review the soldering method or use a sealed or flux-tight switch.	
		Silicon gas exists near the switch.	Remove the material generating gas, or adjust contact capacity to prevent formation of silicon compounds on the contacts.	
	Malfunction	The contacts are separated from each other by vibration or shock.	Use a switch having a high contact force (generally a high OF).	
	Contact welding	The load connected to the switch is too high.	Switch the load with a high-capacity relay or magnetic relay or insert a contact protection circuit.	
	Insulation degradation (burning)	Contacts have been melted and scattered by arc.	Switch the load with a high-capacity relay or magnetic relay.	
		Water has penetrated into the switch because the switch has been used in an extremely hot environment.	Remove the cause of the problem, place the switch in a box, or use a sealed switch.	
Liquid has penetrated into the switch and been carbonized by arc heat.				
Failures related to mechanical characteristics	Actuator	Operating failure	The sliding part of the actuator has been damaged because an excessive force was applied on the actuator.	Make sure that no excessive force is applied to the actuator, or use an auxiliary actuator mechanically strong.
			Foreign material like dust, dirt and oil has penetrated into the switch.	Remove the cause of the problem or place the switch in a box.
			The actuator does not release because the operating body is too heavy.	Use a switch having a higher OF.
			The switch is loosely installed and thus does not operate even when the actuator is at the rated OP.	Secure the switch.
		Low durability	The shape of the dog or cam is improper.	Change the design of the dog or cam.
			The operating method is improper. The operating speed is too high.	Review the operating stroke and operating speed.
		Damage	A shock has been applied to the actuator.	Remove the cause of problem or use a switch mechanically strong.
	The caulked part is not good enough or the assembled condition is poor.		Replace the switch with a new one.	
	Deformation or drop-out Actuator was subjected to an excessive force and force from an inappropriate direction.		Review the handling and operating method.	
	Mounting section	Damage	Screws have not been inserted straight.	Check and correct screw insertion method.
			The mounting screws were tightened with too much torque.	Tighten the screws with an appropriate torque.
			The mounting pitch is wrong.	Correct the pitch.
			The switch is not installed on a flat surface.	Install the switch on a flat surface.
	Terminal	Damage	An excessive force was applied to the terminal while being wired.	Do not apply an excessive force.
The plastic part has been deformed by soldering heat.			Reduce the soldering time or soldering temperature. (Refer to the information given under <i>Precautions</i> for that model.)	

# D3V/V/VX/D2MV/K/D2RV Common Accessories

## Ordering Information

### ■ Actuators (Sold Separately)

Actuators are supplementary components used when operating the Switch using cams or dogs or when transmitting mechanical movements that are not in alignment with the switch plunger.

The VAL models are suitable for cases where a Switch is operated by a rotary cam or sliding devices with relatively low operation frequency.

The VAM models are designed to operate in reverse movements and have high shock and vibration resistance. Since the OT of these models is rather large, these models can be used for automatic control or door switches of machining tools.

The VAV models can be used for cases where a small OF is required.

- Note:**
1. These Actuators do not include Switches.
  2. Switches with the mounting holes shown below can be used except for special models.

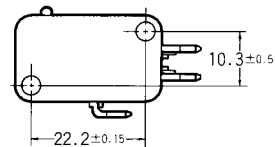

### ■ Separators (Insulation Sheet) (Sold Separately)

Applicable Switches	Thickness	Model
D3V, V, VX, D2MV, K, D2RV, D2VW	0.18	Separator for V0.18
	0.25	Separator for V0.25

**Note:** The Separator is made of epoxy alkyd/varnish tetron cloth and has heat-resistant temperature of 130°C.

#### Separator for V□

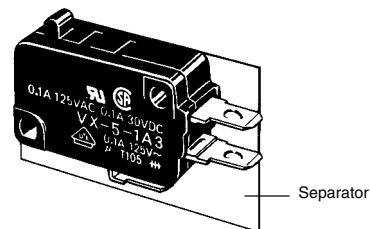

### ■ Dimensions and Operating Characteristics

- Note:**
1. All units are in millimeter unless otherwise indicated.
  2. Unless otherwise specified, a tolerance of  $\pm 0.4$  mm applies to all dimensions.
  3. For operating characteristics of models not listed above, consult your OMRON sales representative.
  4. The operating characteristics are for operation in the A direction (▼).
  5. Model numbers are for the Actuator only.

#### Leaf Spring

VAL (Designed for models of OF 200 gf and greater)

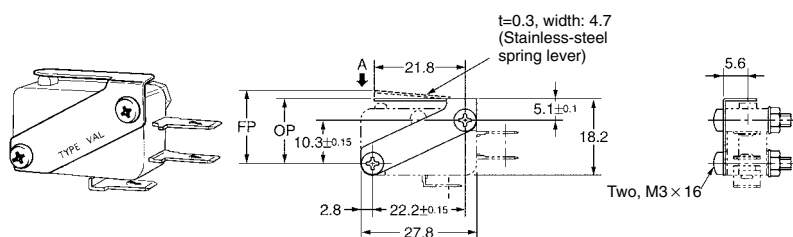

In the case of V-15-1A5	
OF max.	2.26 N {230 gf}
RF min.	0.49 N {50 gf}
OT min.	0.8 mm
MD max.	0.4 mm
FP max.	17 mm
OP	14.9±0.5 mm

### Simulated Leaf Spring

VAL12 (Designed for models of OF 200 gf and greater)

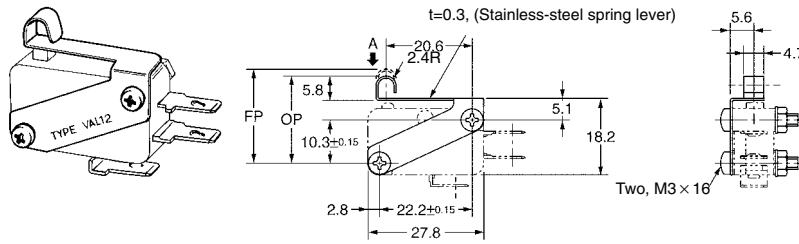

In the case of V-15-1A5	
OF max.	2.26 N {230 gf}
RF min.	0.49 N {50 gf}
OT min.	0.8 mm
MD max.	0.4 mm
FP max.	22.9 mm
OP	20.5±0.8 mm

### Roller Leaf Spring

VAL2, VAL02 (Designed for models of OF 200 gf max.)

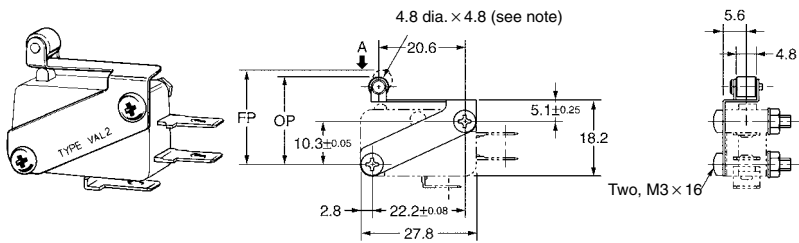

Note: VAL2: Unlubricated polyacetal resin roller  
VAL02: Stainless-steel roller

In the case of V-15-1A5	
OF max.	2.26 N {230 gf}
RF min.	0.49 N {50 gf}
OT min.	0.8 mm
MD max.	0.4 mm
FP max.	22.6 mm
OP	20.5±0.5 mm

### Long Hinge Lever

VAV

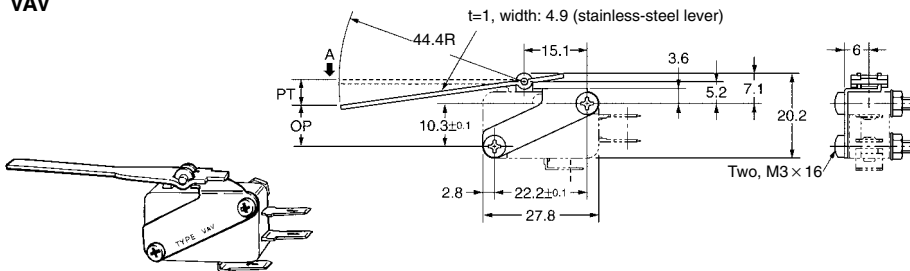

In the case of V-15-1A5	
OF max.	0.34 N {35 gf}
RF min.	0.04 N {4 gf}
PT max.	7.6 mm
OT min.	3.6 mm
MD max.	4.7 mm
OP	Approx. 10.6 mm

### Hinge Wire Lever

VAV-5 (Designed for models of OF 25 gf max.)

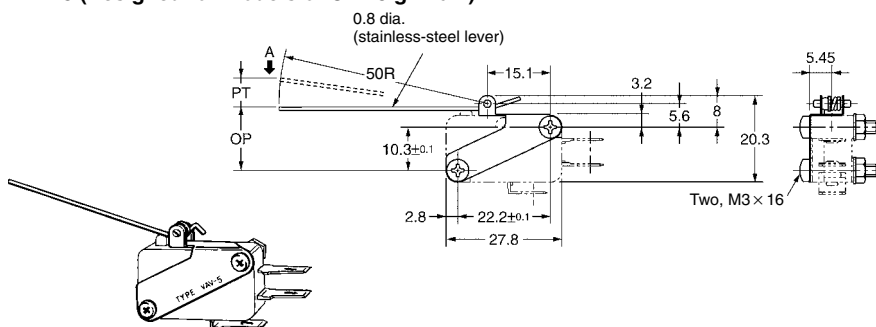

In the case of VX-5-1A2	
OF max.	0.03 N {2.8 gf}
RF min.	0.002 N {0.2 gf}
PT max.	16 mm
OT min.	2 mm
MD max.	5 mm
OP	Approx. 16.7 mm



Hinge Roller Lever

VAV2

4.8 dia. x 4.8 (Unlubricated polyacetal resin roller)

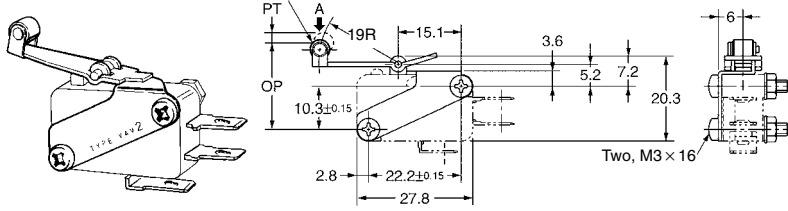

In the case of V-15-1A5	
OF max.	0.74 N {75 gf}
RF min.	0.09 N {9 gf}
PT max.	4.8 mm
OT min.	1.5 mm
MD max.	1.2 mm
OP	18.6±1.6 mm

Reverse Long Hinge Lever

VAM

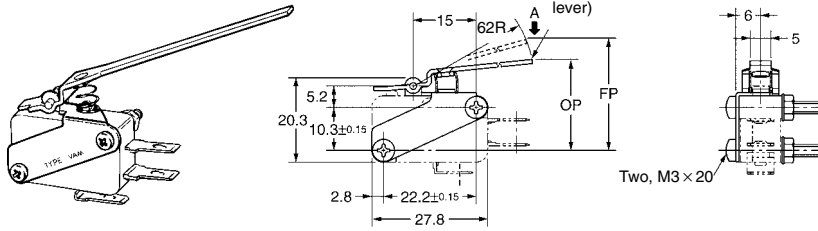

In the case of V-15-1A5	
OF max.	1.96 N {200 gf}
RF min.	0.29 N {30 gf}
OT min.	7 mm (reference value)
MD max.	5 mm
FP max.	45 mm
OP	20±9 mm

Reverse Hinge Lever

VAM21

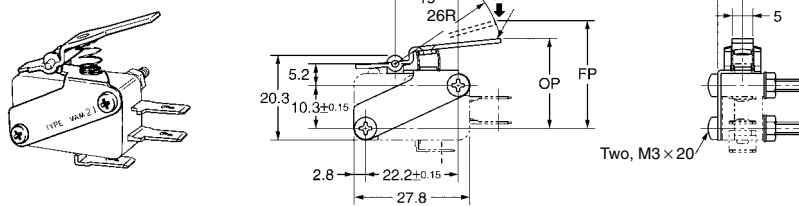

In the case of V-15-1A5	
OF max.	3.53 N {360 gf}
RF min.	0.69 N {70 gf}
OT min.	5 mm (reference value)
MD max.	4 mm
FP max.	30 mm
OP	20±4 mm

Reverse Roller Modified Lever

VAM-1

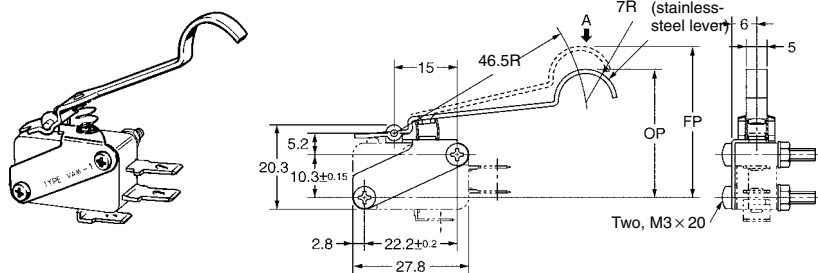

In the case of V-15-1A5	
OF max.	2.94 N {300 gf}
RF min.	0.39 N {40 gf}
OT min.	5 mm (reference value)
MD max.	6 mm
FP max.	47 mm
OP	30±5 mm

www.DataSheet4U.com

**Reverse Hinge Roller Lever**

**VAM22**

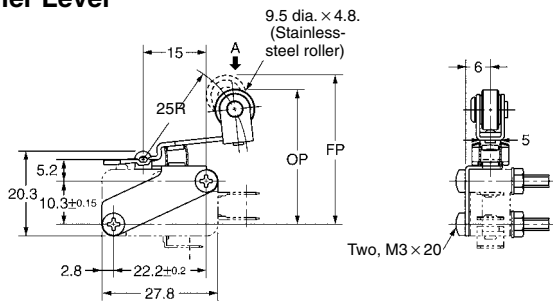
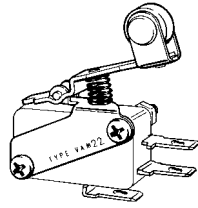

In the case of V-15-1A5	
<b>OF max.</b>	3.53 N {360 gf}
<b>RF min.</b>	0.69 N {70 gf}
<b>OT min.</b>	3 mm (reference value)
<b>MD max.</b>	4 mm
<b>FP max.</b>	38 mm
<b>OP</b>	31.3±3 mm

**Reverse Long Hinge Roller Lever**

**VAM2**

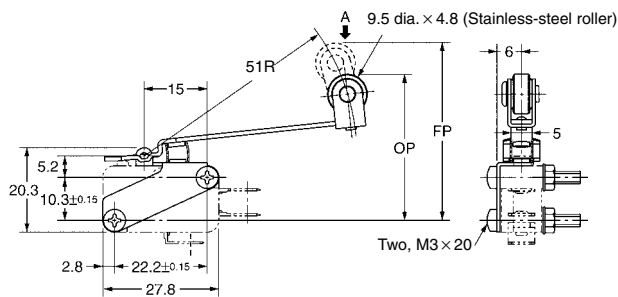
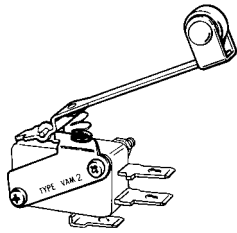

In the case of V-15-1A5	
<b>OF max.</b>	2.45 N {250 gf}
<b>RF min.</b>	0.39 N {40 gf}
<b>OT min.</b>	7 mm (reference value)
<b>MD max.</b>	6 mm
<b>FP max.</b>	48 mm
<b>OP</b>	31±6 mm

# Connectors

Microswitches for tab-terminals listed in this catalog are compatible with other companies' products. The following AMP-made Connectors are also available. For more details about AMP Connectors, contact one of the addresses listed below.

## Tyco Electronics/AMP

- Japan  
Phone: 81-44-844-8013
- U.S.A.  
Phone: 1-800-522-6752
- Great Britain  
Phone: 44-208-954-2356
- Hong Kong  
Phone: 852-2735-1628

## Receptacles for Quick-connect Terminals

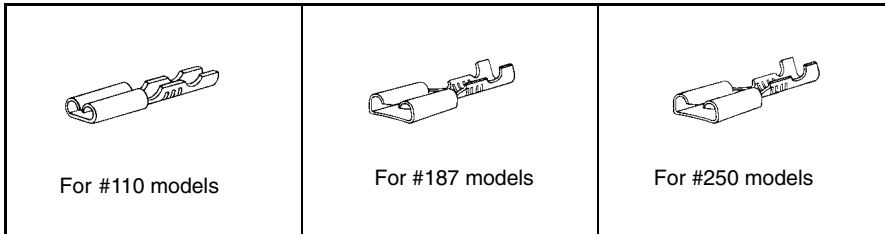

## Positive Lock Connectors

(Connectors with an easy-to-insert, secure lock mechanism.)

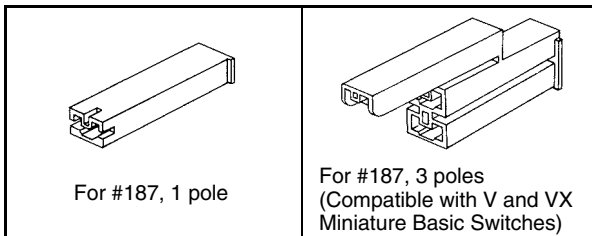

**Note:** Other companies' products are listed in this catalog as general user information. We assume no responsibility for the quality or price of other companies' products.