

GaAs IC 35 dB Voltage Variable Attenuator

Single Positive Control 0.5–2.5 GHz



AV105-12

Features

- Single Positive +5 V Control Voltage
- 35 dB Attenuation Range @ 0.9 GHz
- Excellent Linearity Performance

Description

The AV105-12 GaAs IC FET voltage variable attenuator provides 35 dB attenuation range at 900 MHz controlled by a single positive voltage. The VVA has a linear transfer curve of 8 dB/V slope, with input and output VSWR better than 1.4:1 over all states. Its attenuation range at 1900 MHz is 31 dB. It operates with supply voltage of +5 V and control voltage of 0 V to +5 V in a low cost SOIC-8 package. The RF ports require 25 pF DC blocking capacitors.

SOIC-8

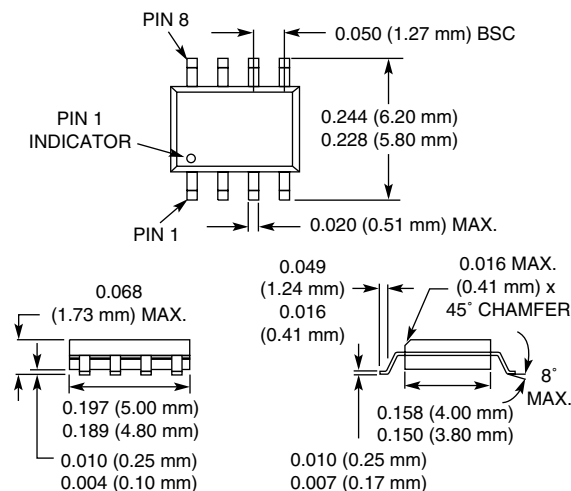

Electrical Specifications at 25°C ($V_S = 5\text{ V}$)

Parameter ¹	Frequency	Min.	Typ.	Max.	Unit
Insertion Loss ($V_C = 5\text{ V}$)	0.5–1.0 GHz		2.8	3.1	dB
	1.0–2.0 GHz		3.2	3.6	dB
	2.0–2.5 GHz		3.5	3.8	dB
Maximum Attenuation ($V_C = 0\text{ V}$) ²	0.5–0.8 GHz	25	33		dB
	0.8–1.0 GHz	35	38		dB
	1.0–1.7 GHz	32	35		dB
	1.7–2.0 GHz	28	31		dB
	2.0–2.5 GHz	26	30		dB
VSWR (I/O) ³	0.5–2.5 GHz		1.8:1		

Operating Characteristics at 25°C ($V_S = 5\text{ V}$)

Parameter	Condition	Frequency	Min.	Typ.	Max.	Unit
Switching Characteristics	Rise, On (10/90% or 50% CTL to 90% RF)			350		nS
	Fall, Off (90/10% RF or 50% CTL to 10% RF)			250		nS
Intermodulation Intercept Point (IIP3) ³	For Two-tone Input Power +0 dBm	0.9 GHz		15		dBm
Control Voltage (V_C)			0		V_S	V
Supply Voltage (V_S)				5.0		V
Control Current (I_C)				800		μA
Supply Current (I_S)				800		μA

1. All measurements made in a 50 Ω system, unless otherwise specified.

2. Maximum attenuation includes insertion loss.

3. For worst case state.

Typical Performance Data @ 0.9 GHz
(Unless Otherwise Specified)

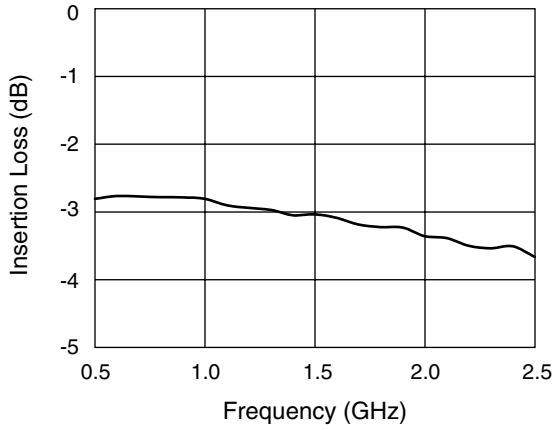

Insertion Loss vs. Frequency

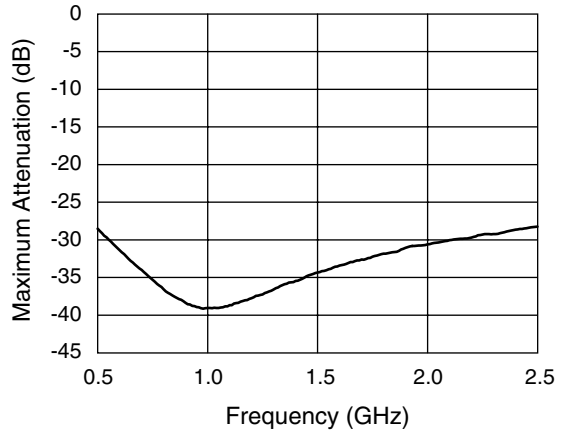

Maximum Attenuation vs. Frequency

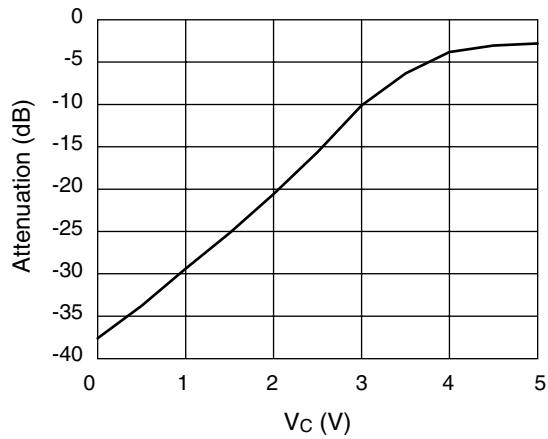

Attenuation vs. Control Voltage

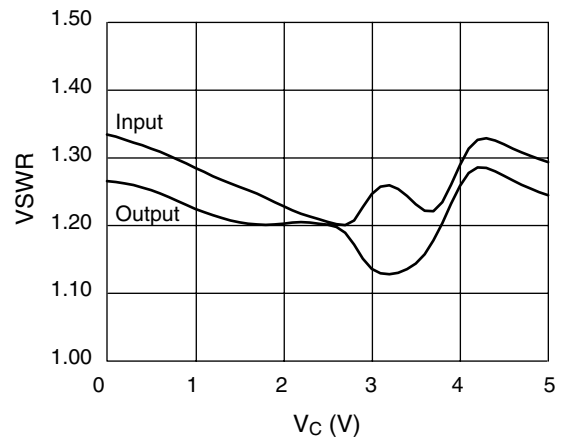

VSWR vs. Control Voltage

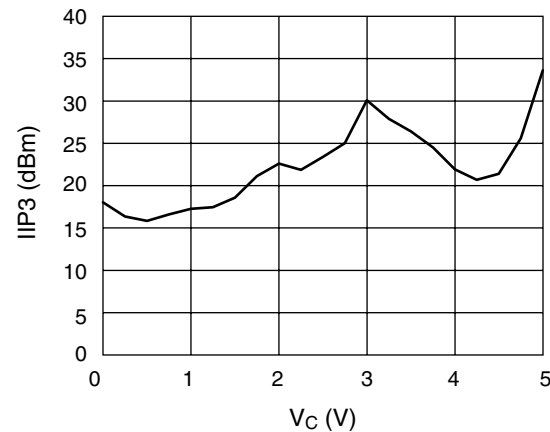

Input IP3 vs. Control Voltage

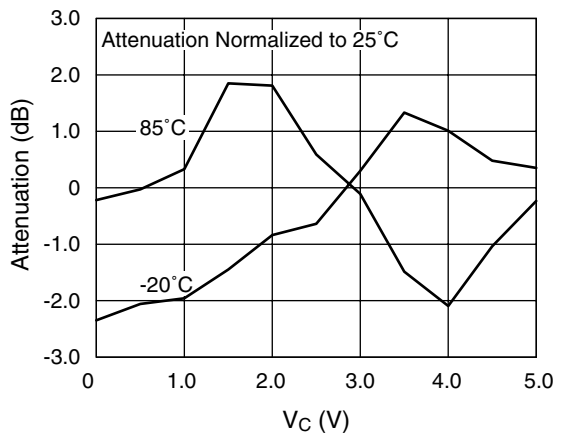

Attenuation vs. Control Voltage Over Temperature

Absolute Maximum Ratings

Characteristic	Value
RF Input Power	50 mW > 500 MHz
Supply Voltage	+4 to +8 V
Control Voltage	$-0.2 \text{ V} < V_C < V_S + 0.2 \text{ V}$
Operating Temperature	-40°C to +85°C
Storage Temperature	-65°C to +150°C
Θ_{JC}	25°C/W

Note: Exceeding these parameters may cause irreversible damage.

Pin Out

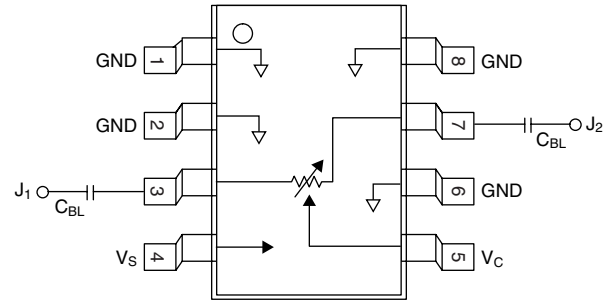

DC blocking capacitors (C_{BL}) supplied externally.
 $C_{BL} = 25 \text{ pF}$ for operation >500 MHz.