

Contadores

Tipo	9A	12A	18A	22A
------	----	-----	-----	-----



Contadores de tres polos

Incluye contacto auxiliar AU-1
(1 N.O. / 1 N.C.)



Voltaje de Entrada		Código		Código		Código		Código	
102-138V	bobina CA	GMC-9-AC120V		GMC-12-AC120V		GMC-18-AC120V		GMC-22-AC120V	
187-253V	bobina CA	GMC-9-AC220V		GMC-12-AC220V		GMC-18-AC220V		GMC-22-AC220V	
21-27V	bobina CD	GMD-9-DC24V		GMD-12-DC24V		GMD-18-DC24V		GMD-22-DC24V	
Conformidad con IEC60947-4		kW	A	kW	A	kW	A	kW	A
CA1			25		25		40		40
CA3	200/240V	2.5	11	3.5	13	4.5	18	5.5	22
	380/440V	4	9	5.5	12	7.5	18	11	22
Conformidad con UL508		hp	A	hp	A	hp	A	hp	A
Corriente continua			20		25		30		32
Monofásico	115V	0.5		0.5		1		2	
	230V	1		2		3		3	
Trifásico	230V	2		3		5		7.5	
	460V	5		7.5		10		10	
Tamaño de NEMA			00		00		0		0

Contadores 9A a 22A

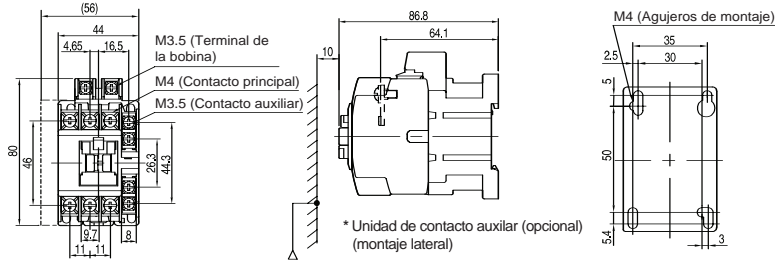

Tipo	6A	9A	12A	18A
------	----	----	-----	-----



Mini Contactores de tres polos incluye contacto auxiliar (1 N.O.)



Voltaje de Entrada		Código		Código		Código		Código	
102-138V	bobina CA	GMC-6M-10-AC120V		GMC-9M-10-AC120V		GMC-12M-10-AC120V		GMC-16M-10-AC120V	
21-27V	bobina CD	GMD-6M-10-DC24V		GMD-9M-10-DC24V		GMD-12M-10-DC24V		GMD-16M-10-DC24V	
Conformidad / EC6 409		kW	A	kW	A	kW	A	kW	A
CA1			20		20		20		20
CA3	200/240V	1.5	7	2.2	9	3	12	4	15
	380/440	2.2	6	4	9	5.5	12	7.5	16
	500/550V	3	5	3.7	6	4	7	5.5	9
	690V	3	4	4	5	4	5	4	5
Conformidad / UL5 08		hp	A	hp	A	hp	A	hp	A
corriente continua			2		25		30		32
Monofásico	115V	0.5		0.5		1		2	
	230V	1		2		3		3	
Trifásico	230V	2		3		5		7.5	
	460V	5		7.5		10		10	
Tamaño de NEMA			00		00		00		00

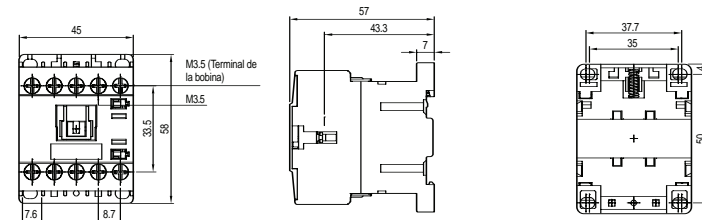

Contadores



32A		40A		50A		65A		75A		85A	
		<i>Incluye 2 contactos auxiliares AU-1 (2 N.O. / 2 N.C.)</i>								*	
Código		Código		Código		Código		Código		Código	
GMC-32-AC120V		GMC-40-AC120V		GMC-50-AC120V		GMC-65-AC120V		GMC-75-AC120V		GMC-85-AC120V	
GMC-32-AC220V		GMC-40-AC220V		GMC-50-AC220V		GMC-65-AC220V		GMC-75-AC220V		GMC-85-AC220V	
GMD-32-DC24V		GMD-40-DC24V		GMD-50-DC24V		GMD-65-DC24V		GMD-75-DC24V		GMD-85-DC24V	
kW	A	kW	A	v	A	kW	A	kW	A	kW	A
50		60		80		100		110		135	
7.5	32	11	40	15	55	18.5	65	22	75	25	85
15	32	18.5	40	22	50	30	65	37	75	45	85
hp	A	hp	A	hp	A	hp	A	hp	A	hp	A
45		50		70		80		90		100	
2		3		3		5		5		7.5	
5		5		7.5		10		15		15	
10		10		15		20		25		30	
20		25		30		40		50		50	
1		1		2		2		2		3	

* También disponibles pero no ilustrados contactores y relevadores de sobrecarga de 100 a 800 Amps. Así como bobinas en diferentes voltajes CA y CD.

Contadores de 32A a 40A

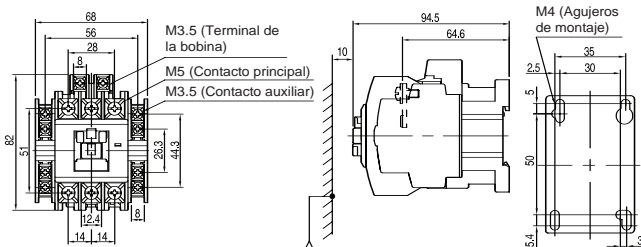

Contadores de 50A a 85A

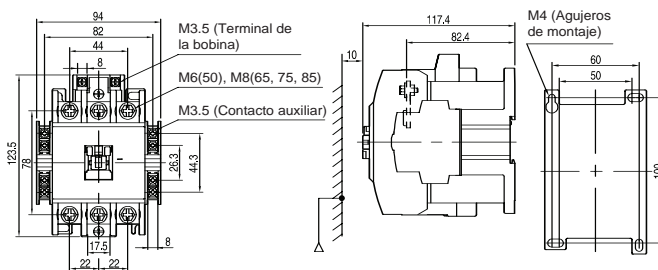

Contactos auxiliares e interlock mecánicos

Para Contactores Estandar



Función	1 N.O./1 N.C.	2 N.O./2 N.C.	Interlock
Código	AU-2-11	AU-4-22	AR-9

Para Mini Contactores

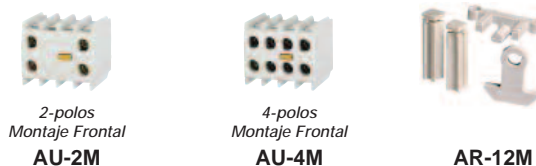

Función	1 N.O./1 N.C.	2 N.O./2 N.C.	Interlock
Código	AU-2M-11	AU-4M-22	AR-12M

Relevadores de Sobre Carga

Para Contactores Estandar

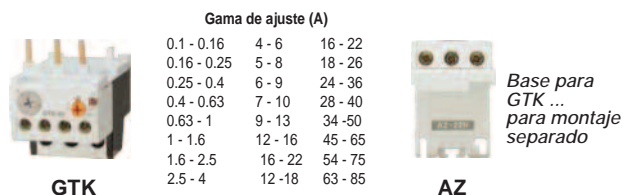

Código	GTK-22-* A	(para 9 a 22A)	AZ-22H
Código	GTK-40-* A	(para 32 a 40A)	AZ-40H
Código	GTK-85-* A	(para 50 a 85A)	AZ-85H

Para Mini Contactores



Código	GTK-12M-* A	AZ-12H
--------	-------------	--------

Por favor seleccione su rango y remplace por la *.
Ejemplo GTK-22-*A para un rango de 0.63-1 sera GTK-22-0.63-1A.

Clema Relevador con LED Serie RS

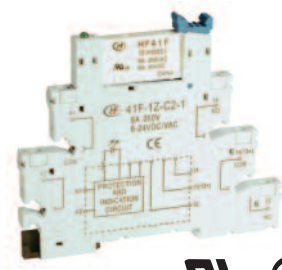

Montaje en Riel DIN.

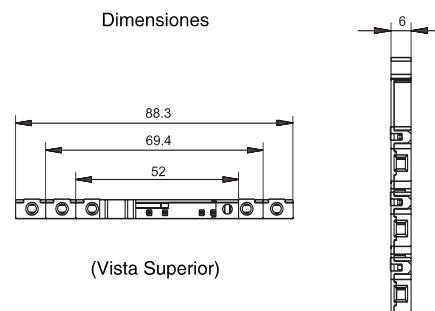
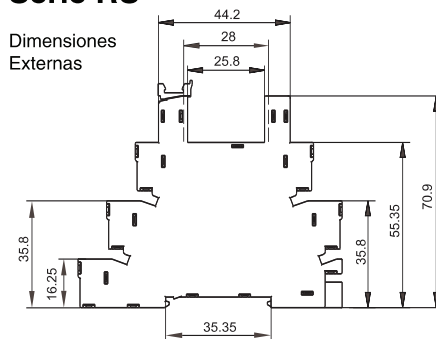

Código	Voltaje	Amperaje	Tipo de Contacto
RSM-12CU	12V CA/CD	6A	Un polo, dos tiros
RSM-24CU	24V CA/CD	6A	Un polo, dos tiros
RSM-110U	110V CA/CD	6A	Un polo, dos tiros
RSM-220U	220V CA/CD	6A	Un polo, dos tiros

Relevadores Encapsulados con LED Serie RL

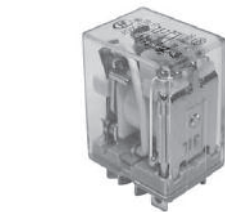

RLS-2

Serie RL1/RL2

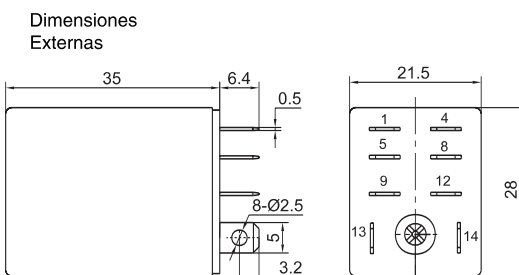

Esquemas

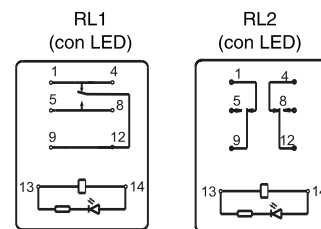

(Vista Inferior)

Código	Voltaje	Amperaje	Tipo de Contacto
RL1L-D24	24V CD	15A	Un polo, dos tiros
RL2L-D24	24V CD	10A	Dos polos, dos tiros
RL1L-A120	110V CA	15A	Un polo, dos tiros
RL2L-A120	110V CA	10A	Dos polos, dos tiros

RLS-2 - Socket de relevador para montaje en riel DIN/panel

Relevadores Encapsulados con LED Serie RG



RGS

Dimensiones Externas

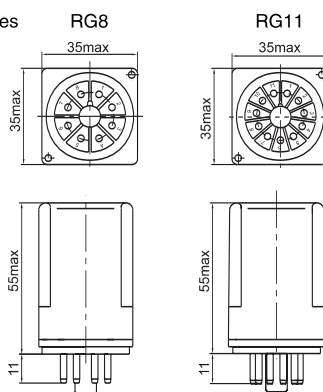

Esquemas

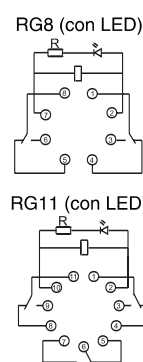

Código	Voltaje	Amperaje	Tipo de Contacto
RG8L-D24	24V CD	10A	Dos polos, dos tiros
RG8L-A110	110V CA	10A	Dos polos, dos tiros
RGS-8	-	-	- Socket de relevador para montaje en riel DIN/panel, 8 pin
RG11L-D24	24V CD	10A	Tres polos, dos tiros
RG11L-A110	110V CA	10A	Tres polos, dos tiros
RGS-11	-	-	- Socket de relevador para montaje en riel DIN/panel, 11 pin