

PVA

Short Stroke Key Switches

Features/Benefits

- Compact design
- Short stroke to latch
- Wide variety of actuator heights and styles
- Adapted for medium power applications
- RoHS compliant and compatible

Typical Applications

- Automotive (air conditioning, lighting)
- Video, remote controls
- Electronic games



Construction

FUNCTION: Momentary, Push-Push

CONTACT ARRANGEMENT:¹

PVA1: 2 make contacts (DPST)

PVA2: 2 change over contacts (DPDT)

MODE SWITCHING: Non-shorting

TERMINALS: PC pins²

Mechanical

TOTAL TRAVEL / LATCHING TRAVEL:

OA: 2,4± 0,2 (0.094 ± 0.008)

EE: 2,4± 0,2 (0.094 ± 0.008)/ 1,5 (0.059)

OPERATING FORCE: 1.2 ± .25 (120 grams);

1.7 ± .25 (170 grams); 3.5 ± .25 (350 grams)

Process

SOLDERABILITY:

Hand soldering: 350°C for 3 seconds

Wave or bath soldering: 260°C for 5 seconds

Cleaning: Use solvents compatible with ABS

Electrical

SWITCHING POWER MAX.: 3 W DC

SWITCHING VOLTAGE MAX.: 32 V DC

SWITCHING CURRENT MAX.: 100 mA DC*

DIELECTRIC STRENGTH (50 Hz / 1 min):

1000 V between open contacts, PVA2: 750 V

OPERATING LIFE:

OA (momentary): ≥ 1 × 10⁵ operations

EE (push-push): ≥ 1 × 10⁵ operations

CONTACT RESISTANCE: Initial ≤ 100 mΩ; 50mΩ

After life:150 mΩ

INSULATION RESISTANCE: ≥ 10¹⁰ Ω

BOUNCE TIME: ≤ 3 ms

Environmental

OPERATING TEMPERATURE: -40°C to 85°C.³

1) Other contact arrangements available by request

2) "Snap-in" contacts on request, Version SNA with pins bent inside (standard)

3) With button +70°C

* By 13,8 VDC, the PVA supports a peak current of 500 mA and a continuous current of 200 mA.

Note: Specifications listed above are for switches with standard options.

For information on specific and custom switches, consult Customer Service Center.

How To Order

Our easy build-a-switch concept allows you to mix and match options to create the switch you need. To order, select desired option from each category and place it in the appropriate box.

Switch

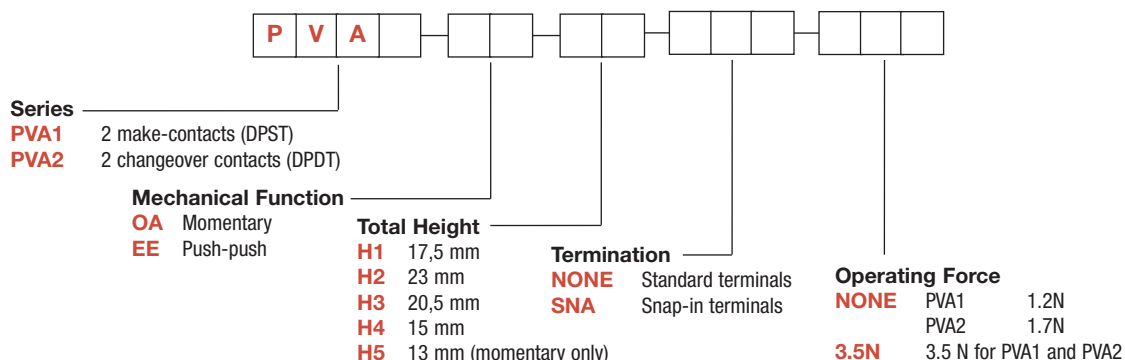

Button

Buttons must be ordered separately.
Shipped in bulk.

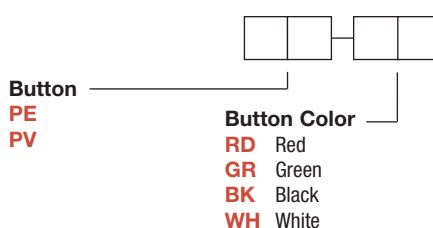

Dimensions are shown: mm (inch)
Specifications and dimensions subject to change

www.ittcannon.com

PVA Short Stroke Key Switches

SERIES

PVA1 (DPST)

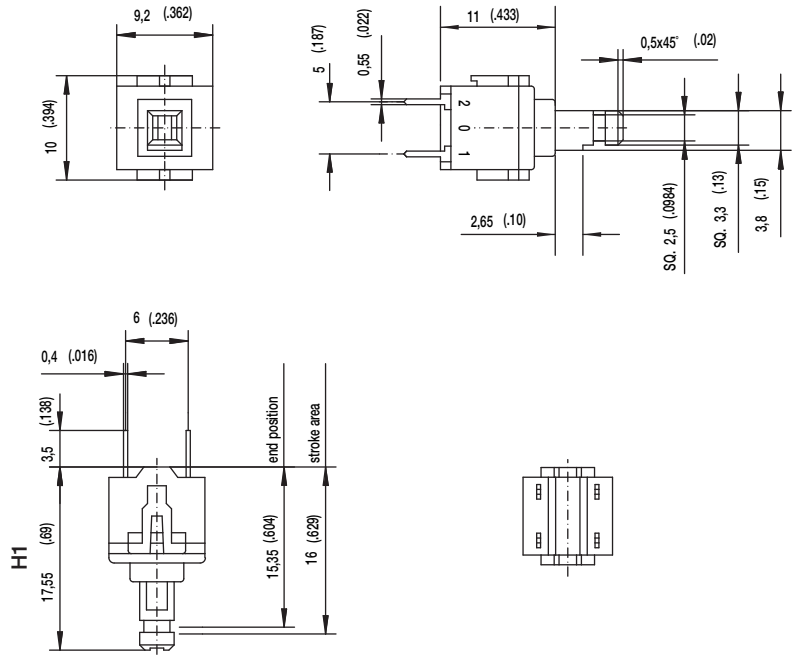
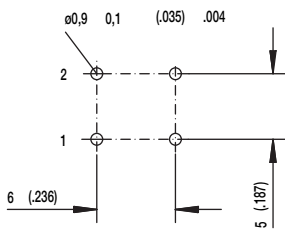

PVA2 (DPDT)

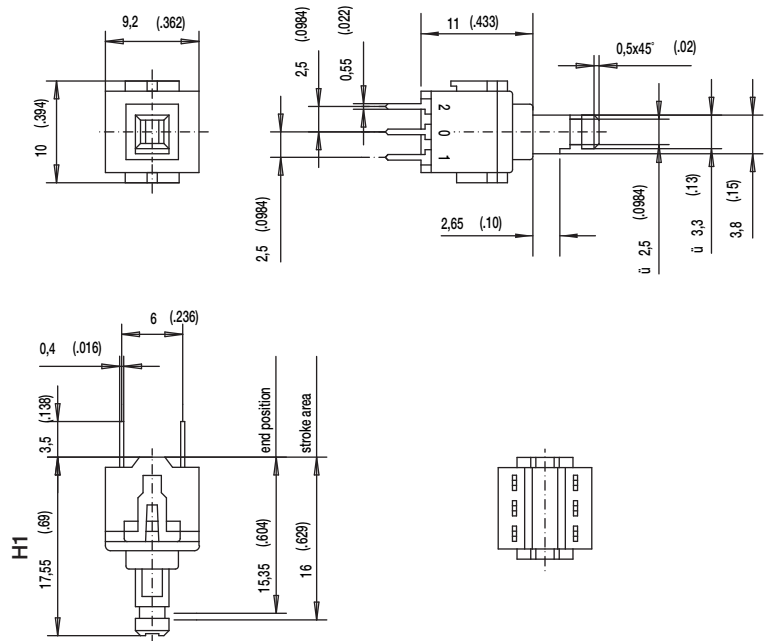
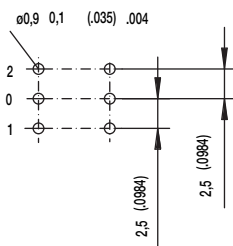

MECHANICAL FUNCTION

OPTION CODE	FUNCTION
OA	Momentary
EE	Push-Push

OA

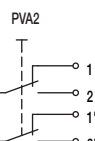
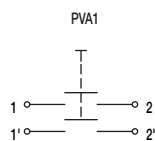

EE

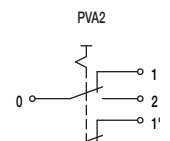
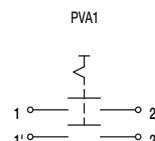

Dimensions are shown: mm (inch)
Specifications and dimensions subject to change

PVA Short Stroke Key Switches

TOTAL HEIGHT

H1 17,5 MM

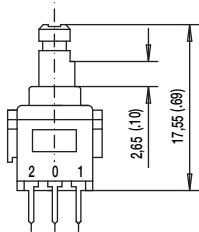

H2 23 MM

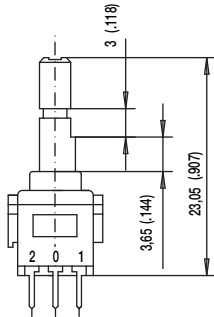

H3 20,5 MM

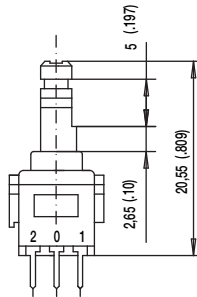

H4 15 MM

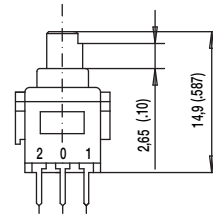

H5 13 MM
(MOMENTARY ONLY)

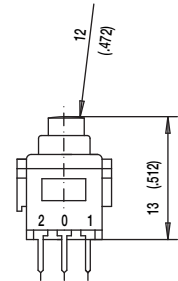

TERMINATION

SNA

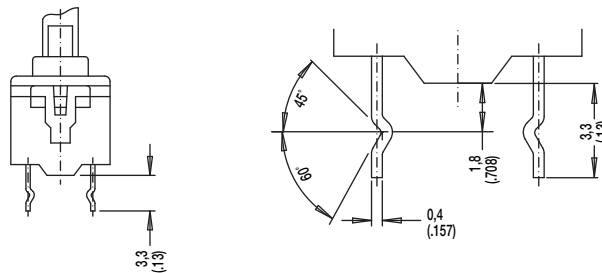

OPERATING FORCE

NONE PVA1 1.2 N
PVA2 1.7 N

3.5N 3.5 NEWTONS PVA1 & PVA2

BUTTONS

BUTTONS MUST BE ORDERED SEPARATELY. SHIPPED IN BULK.

PE

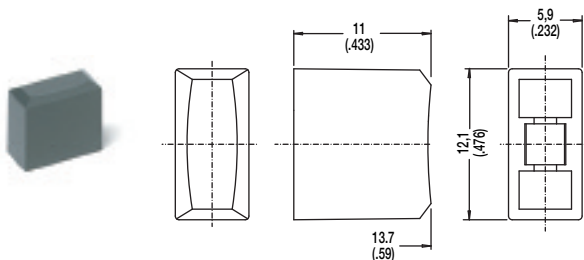

PV

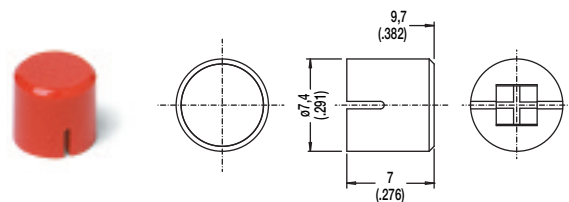

OPTION CODE	COLOR
RD	Red
GY	Gray
BK	Black
WH	White



Dimensions are shown: mm (inch)
Specifications and dimensions subject to change

www.ittcannon.com

