

# A1321/A1322/A1323

## Ratiometric Linear Hall Effect Sensor for High-Temperature Operation

Package UA, 3-pin SIP

1. VCC
2. GND
3. VOUT

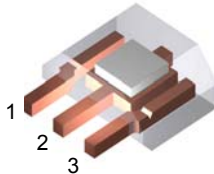

Package LH, 3-pin Surface Mount

1. VCC
2. VOUT
3. GND

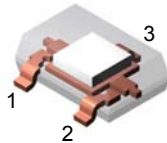

### ABSOLUTE MAXIMUM RATINGS

Supply Voltage, $V_{CC}$ .....	8 V*
Reverse-Battery Voltage, $V_{RCC}$ .....	-0.1 V
Reverse-Output Voltage, $V_{ROUT}$ .....	-0.1 V
Output Sink Current, $I_{OUT}$ .....	10 mA
Operating Temperature	
Ambient, $T_A$ , Range E .....	-40°C to 85°C
Ambient, $T_A$ , Range L .....	-40°C to 150°C
Maximum Junction, $T_{J(max)}$ .....	165°C
Storage Temperature, $T_S$ .....	-65°C to 170°C

\*Additional current draw may be observed at voltages above the minimum supply Zener clamp voltage,  $V_{Z(min)}$ , due to the Zener diode turning on.

The A132X family of linear Hall-effect sensors are optimized, sensitive, and temperature-stable. These ratiometric Hall-effect sensors provide a voltage output that is proportional to the applied magnetic field. The A132X family has a quiescent output voltage that is 50% of the supply voltage and output sensitivity options of 2.5mV/G, 3.125mV/G, and 5mV/G. The features of this family of devices are ideal for use in the harsh environments found in automotive and industrial linear and rotary position sensing systems.

Each device has a BiCMOS monolithic circuit which integrates a Hall element, improved temperature-compensating circuitry to reduce the intrinsic sensitivity drift of the Hall element, a small-signal high-gain amplifier, and a rail-to-rail low-impedance output stage.

A proprietary dynamic offset cancellation technique, with an internal high-frequency clock, reduces the residual offset voltage normally caused by device overmolding, temperature dependencies, and thermal stress. The high frequency clock allows for a greater sampling rate, which results in higher accuracy and faster signal processing capability. This technique produces devices that have an extremely stable quiescent output voltage, are immune to mechanical stress, and have precise recoverability after temperature cycling. Having the Hall element and an amplifier on a single chip minimizes many problems normally associated with low-level analog signals.

Output precision is obtained by internal gain and offset trim adjustments made at end-of-line during the manufacturing process.

The A132X family is provided in a 3-pin single in-line package (UA) and a 3-pin surface mount package (LH).

### Features and Benefits

- Temperature-stable quiescent output voltage
- Precise recoverability after temperature cycling
- Output voltage proportional to magnetic flux density
- Ratiometric rail-to-rail output
- Improved sensitivity
- 4.5 to 5.5 V operation
- Immunity to mechanical stress
- Solid-state reliability
- Robust EMC protection

Use the following complete part numbers when ordering:

Part Number	Package	Ambient	Sensitivity, Typ.
A1321EUA	SIP	-40°C to 85°C	5.000 mV/G
A1321ELH	Surface Mount		
A1321LUA	SIP	-40°C to 150°C	3.125 mV/G
A1321LLH	Surface Mount		
A1322EUA	SIP	-40°C to 85°C	3.125 mV/G
A1322ELH	Surface Mount		
A1322LUA	SIP	-40°C to 150°C	2.500 mV/G
A1322LLH	Surface Mount		
A1323EUA	SIP	-40°C to 85°C	2.500 mV/G
A1323ELH	Surface Mount		
A1323LUA	SIP	-40°C to 150°C	2.500 mV/G
A1323LLH	Surface Mount		

# A1321/A1322/A1323

## Ratiometric Linear Hall Effect Sensor for High-Temperature Operation

### Functional Block Diagram

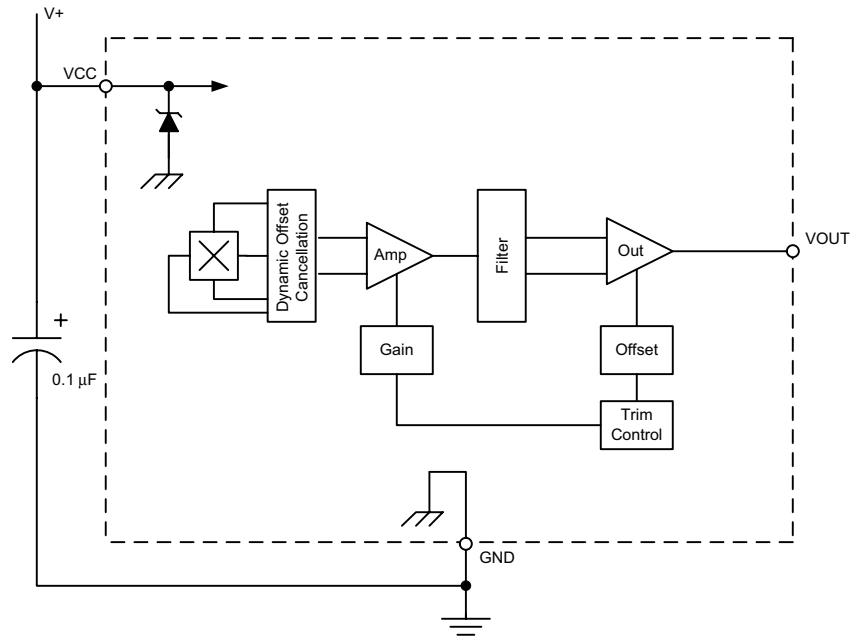

#### Terminal List

Symbol	Description	Number	
		Package LH	Package UA
VCC	Connects power supply to chip	1	1
VOUT	Output from circuit	2	3
GND	Ground	3	2

# A1321/A1322/A1323

## Ratiometric Linear Hall Effect Sensor for High-Temperature Operation

**DEVICE CHARACTERISTICS**<sup>1</sup> over operating temperature ( $T_A$ ) range, unless otherwise noted

Characteristic	Symbol	Test Conditions	Min.	Typ. <sup>2</sup>	Max.	Units
<b>Electrical Characteristics;</b> $V_{CC} = 5\text{ V}$ , unless otherwise noted						
Supply Voltage	$V_{CC(OP)}$	Operating; $T_j < 165^\circ\text{C}$	4.5	5.0	5.5	V
Supply Current	$I_{CC}$	$B = 0, I_{out} = 0$	–	5.6	8	mA
Quiescent Voltage	$V_{out(Q)}$	$B = 0, T_A = 25^\circ\text{C}, I_{out} = 1\text{ mA}$	2.425	2.5	2.575	V
Output Voltage <sup>3</sup>	$V_{out(H)}$	$B = +X, I_{out} = -1\text{ mA}$	–	4.7	–	V
	$V_{out(L)}$	$B = -X, I_{out} = 1\text{ mA}$	–	0.2	–	V
Output Source Current Limit <sup>3</sup>	$I_{out(LM)}$	$B = -X, V_{out} \rightarrow 0$	-1.0	-1.5	–	mA
Supply Zener Clamp Voltage	$V_Z$	$I_{CC} = 11\text{ mA} = I_{CC(max)} + 3$	6	8.3	–	V
Output Bandwidth	BW		–	30	–	kHz
Clock Frequency	$f_C$		–	150	–	kHz
<b>Output Characteristics;</b> over $V_{CC}$ range, unless otherwise noted						
Noise, Peak-to-Peak <sup>4</sup>	$V_N$	A1321; $C_{bypass} = 0.1\text{ }\mu\text{F}$ , no load	–	–	40	mV
		A1322; $C_{bypass} = 0.1\text{ }\mu\text{F}$ , no load	–	–	25	mV
		A1323; $C_{bypass} = 0.1\text{ }\mu\text{F}$ , no load	–	–	20	mV
Output Resistance	$R_{out}$	$I_{out} \leq \pm 1\text{ mA}$	–	1.5	3	$\Omega$
Output Load Resistance	$R_L$	$I_{out} \leq \pm 1\text{ mA}, V_{OUT}$ to GND	4.7	–	–	k $\Omega$
Output Load Capacitance	$C_L$	$V_{OUT}$ to GND	–	–	10	nF

<sup>1</sup> Negative current is defined as conventional current coming out of (sourced from) the specified device terminal.

<sup>2</sup> Typical data is at  $T_A = 25^\circ\text{C}$ . They are for initial design estimations only, and assume optimum manufacturing and application conditions. Performance may vary for individual units, within the specified maximum and minimum limits.

<sup>3</sup> In these tests, the vector **X** is intended to represent positive and negative fields sufficient to swing the output driver between fully OFF and saturated (ON), respectively. It is NOT intended to indicate a range of linear operation.

<sup>4</sup> Noise specification includes both digital and analog noise.

# A1321/A1322/A1323

## Ratiometric Linear Hall Effect Sensor for High-Temperature Operation

**MAGNETIC CHARACTERISTICS**<sup>1,2</sup> over operating temperature range,  $T_A$ ;  $V_{CC} = 5\text{ V}$ ,  $I_{out} = -1\text{ mA}$ ; unless otherwise noted

Characteristics	Symbol	Test Condition	Min	Typ <sup>3</sup>	Max	Units <sup>4</sup>
Sensitivity <sup>5</sup>	Sens	A1321; $T_A = 25^\circ\text{C}$	4.750	5.000	5.250	mV/G
		A1322; $T_A = 25^\circ\text{C}$	2.969	3.125	3.281	mV/G
		A1323; $T_A = 25^\circ\text{C}$	2.375	2.500	2.625	mV/G
Delta $V_{out(q)}$ as a function of temperature	$V_{out(q)(\Delta T)}$	Defined in terms of magnetic flux density, B	–	–	$\pm 10$	G
Ratiometry, $V_{out(q)}$	$V_{out(q)(\Delta V)}$		–	–	$\pm 1.5$	%
Ratiometry, Sens	$\Delta\text{Sens}_{(\Delta V)}$		–	–	$\pm 1.5$	%
Positive Linearity	Lin+		–	–	$\pm 1.5$	%
Negative Linearity	Lin–		–	–	$\pm 1.5$	%
Symmetry	Sym		–	–	$\pm 1.5$	%
<b>UA Package</b>						
Delta Sens at $T_A = \text{max}$ <sup>5</sup>	$\Delta\text{Sens}_{(T_{A\text{max}})}$	From hot to room temperature	–2.5	–	7.5	%
Delta Sens at $T_A = \text{min}$ <sup>5</sup>	$\Delta\text{Sens}_{(T_{A\text{min}})}$	From cold to room temperature	–6	–	4	%
Sensitivity Drift <sup>6</sup>	$\text{Sens}_{\text{Drift}}$	$T_A = 25^\circ\text{C}$ ; after temperature cycling and over time	–	1	2	%
<b>LH Package</b>						
Delta Sens at $T_A = \text{max}$ <sup>5</sup>	$\Delta\text{Sens}_{(T_{A\text{max}})}$	From hot to room temperature	–5	–	5	%
Delta Sens at $T_A = \text{min}$ <sup>5</sup>	$\Delta\text{Sens}_{(T_{A\text{min}})}$	From cold to room temperature	–3.5	–	8.5	%
Sensitivity Drift <sup>6</sup>	$\text{Sens}_{\text{Drift}}$	$T_A = 25^\circ\text{C}$ ; after temperature cycling and over time	–	0.328	2	%

<sup>1</sup> Additional information on characteristics is provided in the section Characteristics Definitions, on the next page.

<sup>2</sup> Negative current is defined as conventional current coming out of (sourced from) the specified device terminal.

<sup>3</sup> Typical data is at  $T_A = 25^\circ\text{C}$ , except for  $\Delta\text{Sens}$ , and at x.x Sens. Typical data are for initial design estimations only, and assume optimum manufacturing and application conditions. Performance may vary for individual units, within the specified maximum and minimum limits. In addition, the typical values vary with gain.

<sup>4</sup> 10 G = 1 millitesla.

<sup>5</sup> After 150°C pre-bake and factory programming.

<sup>6</sup> Sensitivity drift is the amount of recovery with time.

## Characteristic Definitions

**Quiescent Voltage Output.** In the quiescent state (no magnetic field), the output equals one half of the supply voltage over the operating voltage range and the operating temperature range. Due to internal component tolerances and thermal considerations, there is a tolerance on the quiescent voltage output both as a function of supply voltage and as a function of ambient temperature. For purposes of specification, the quiescent voltage output as a function of temperature is defined in terms of magnetic flux density, B, as:

$$\Delta V_{\text{out}(q)(\Delta T)} = \frac{\Delta V_{\text{out}(q)(T_A)} - \Delta V_{\text{out}(q)(25^\circ\text{C})}}{\text{Sens}_{(25^\circ\text{C})}} \quad (1)$$

This calculation yields the device's equivalent accuracy, over the operating temperature range, in gauss (G).

**Sensitivity.** The presence of a south-pole magnetic field perpendicular to the package face (the branded surface) increases the output voltage from its quiescent value toward the supply voltage rail by an amount proportional to the magnetic field applied. Conversely, the application of a north pole will decrease the output voltage from its quiescent value. This proportionality is specified as the sensitivity of the device and is defined as:

$$\text{Sens} = \frac{\Delta V_{\text{out}(-B)} - \Delta V_{\text{out}(+B)}}{2B} \quad (2)$$

The stability of sensitivity as a function of temperature is defined as:

$$\Delta \text{Sens}_{(\Delta T)} = \frac{\Delta \text{Sens}_{(T_A)} - \Delta \text{Sens}_{(25^\circ\text{C})}}{\text{Sens}_{(25^\circ\text{C})}} \times 100\% \quad (3)$$

**Ratiometric.** The A132X family features a ratiometric output. The quiescent voltage output and sensitivity are proportional to the supply voltage (ratiometric).

The percent ratiometric change in the quiescent voltage output is defined as:

$$\Delta V_{\text{out}(q)(\Delta V)} = \frac{\Delta V_{\text{out}(q)(V_{CC})} \div \Delta V_{\text{out}(q)(5V)}}{V_{CC} \div 5V} \times 100\% \quad (4)$$

and the percent ratiometric change in sensitivity is defined as:

$$\Delta \text{Sens}_{(\Delta V)} = \frac{\Delta \text{Sens}_{(V_{CC})} \div \Delta \text{Sens}_{(5V)}}{V_{CC} \div 5V} \times 100\% \quad (5)$$

**Linearity and Symmetry.** The on-chip output stage is designed to provide a linear output with a supply voltage of 5 V. Although application of very high magnetic fields will not damage these devices, it will force the output into a non-linear region. Linearity in percent is measured and defined as:

$$\text{Lin+} = \frac{\Delta V_{\text{out}(+B)} - \Delta V_{\text{out}(q)}}{2(\Delta V_{\text{out}(+B/2)} - V_{\text{out}(q)})} \times 100\% \quad (6)$$

$$\text{Lin-} = \frac{\Delta V_{\text{out}(-B)} - \Delta V_{\text{out}(q)}}{2(\Delta V_{\text{out}(-B/2)} - V_{\text{out}(q)})} \times 100\% \quad (7)$$

and output symmetry as:

$$\text{Sym} = \frac{\Delta V_{\text{out}(+B)} - \Delta V_{\text{out}(q)}}{\Delta V_{\text{out}(q)} - V_{\text{out}(-B)}} \times 100\% \quad (8)$$

# A1321/A1322/A1323

## Ratiometric Linear Hall Effect Sensor for High-Temperature Operation

### Typical Characteristics (30 pieces, 3 fabrication lots)

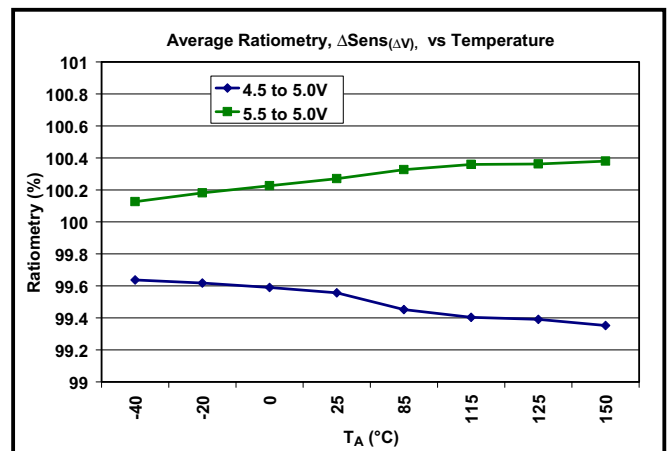
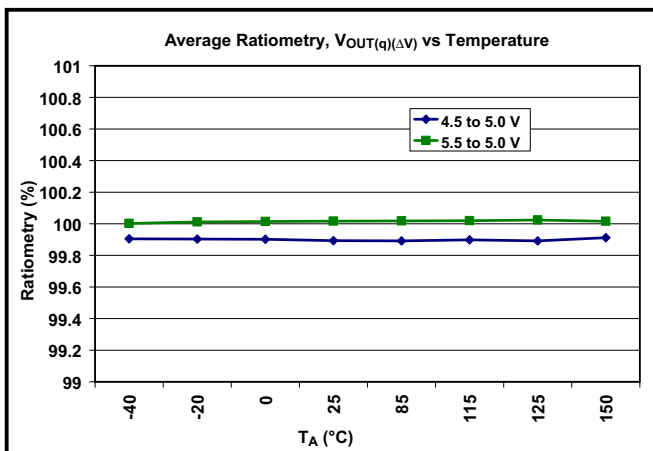
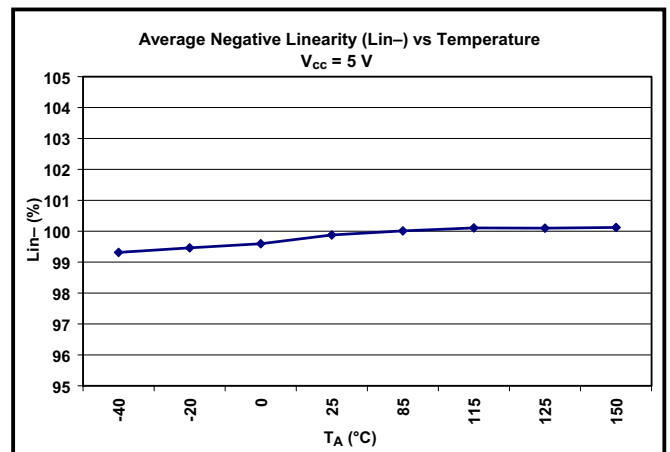
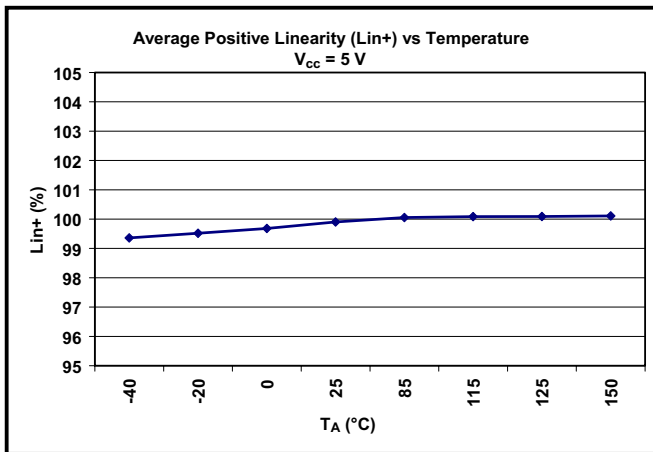
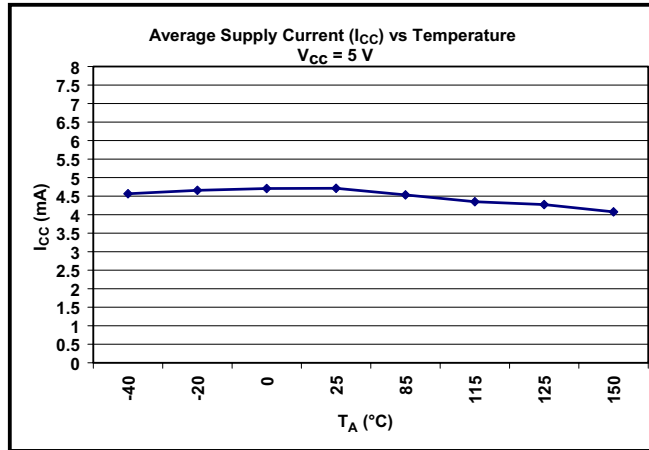

Continued on the next page...

# A1321/A1322/A1323

## Ratiometric Linear Hall Effect Sensor for High-Temperature Operation

### Typical Characteristics, continued (30 pieces, 3 fabrication lots)

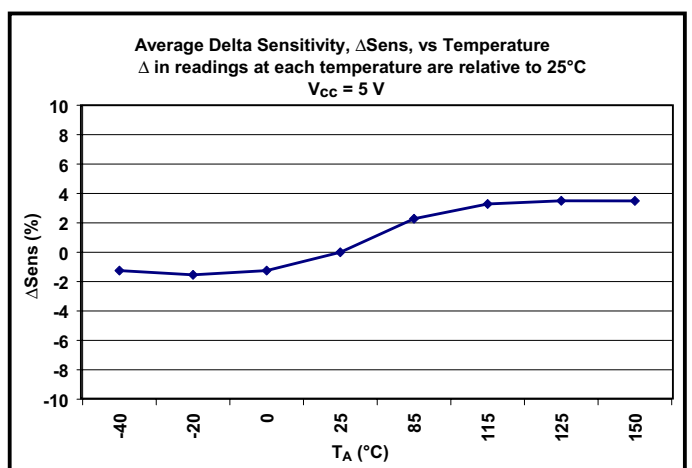
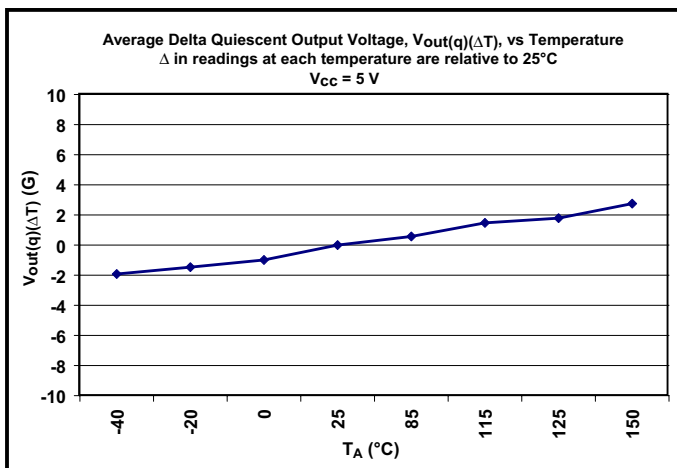
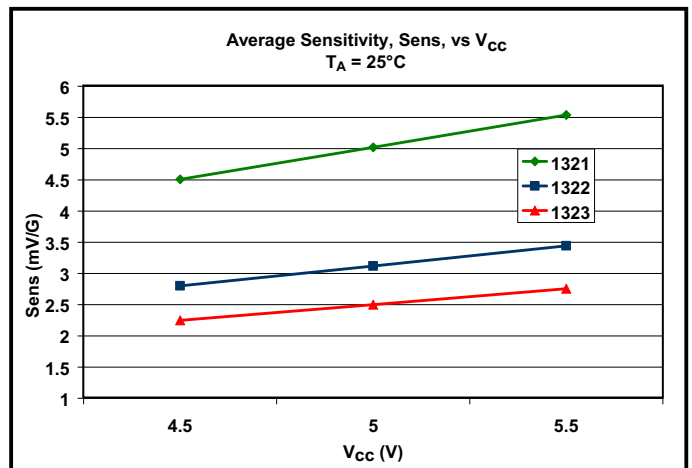
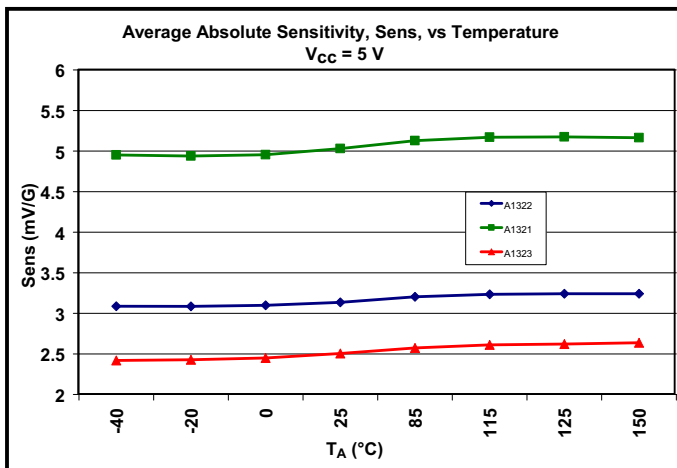
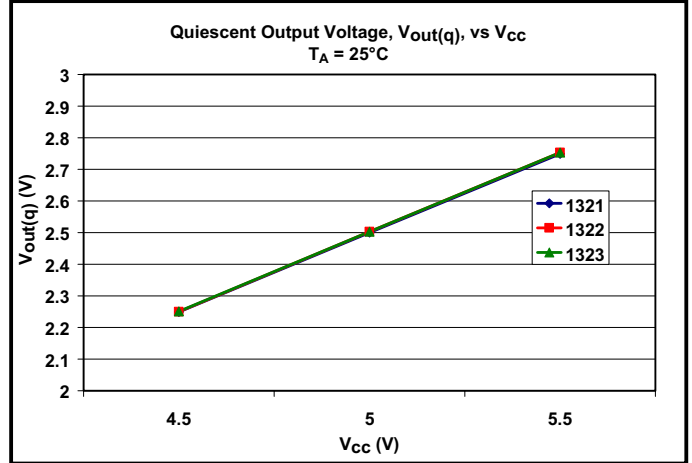
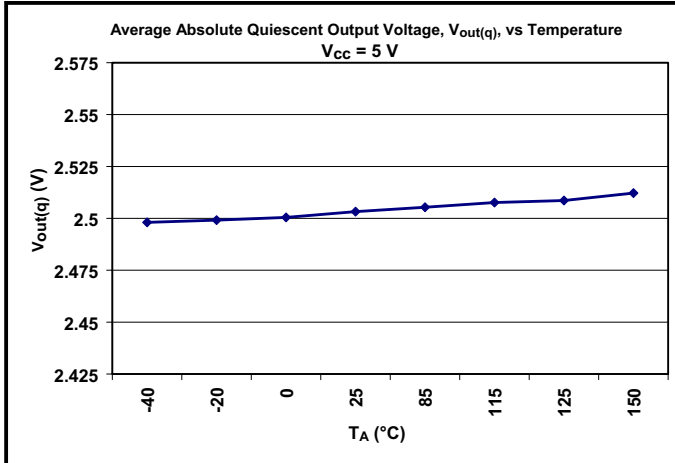

# A1321/A1322/A1323

## Ratiometric Linear Hall Effect Sensor for High-Temperature Operation

### Package LH, 3-Pin; (SOT-23W)

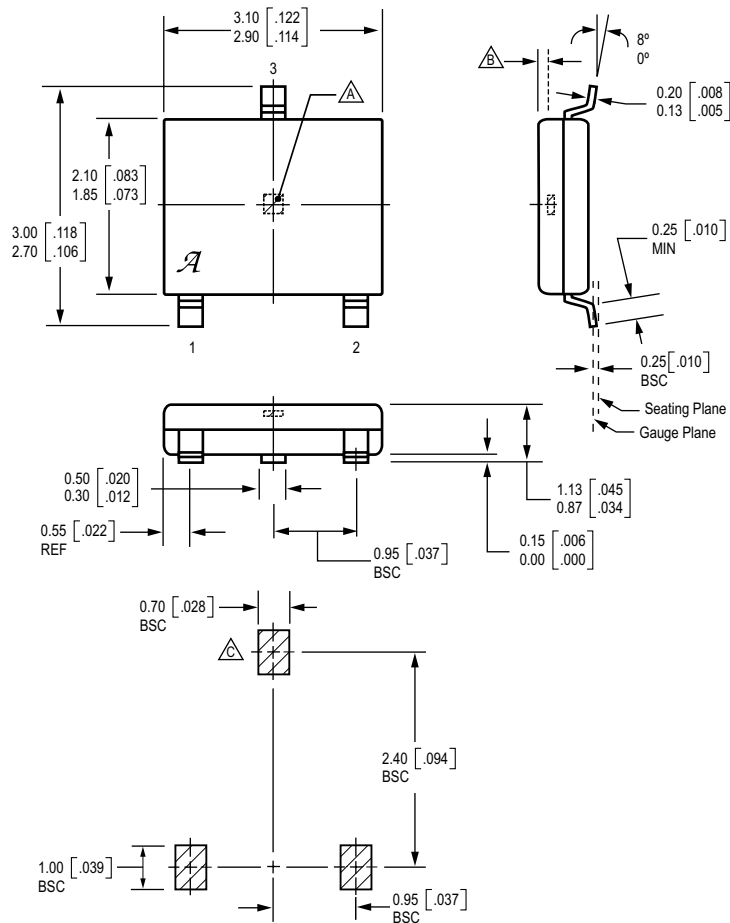

Dimensions in millimeters  
 U.S. Customary dimensions (in.) in brackets, for reference only

△ Hall element  
 △ Active Area Depth 0.28 [.011]  
 △ Fits SC-59A Solder Pad Layout



# A1321/A1322/A1323

## Ratiometric Linear Hall Effect Sensor for High-Temperature Operation

### Package UA, 3-Pin; (TO-92)

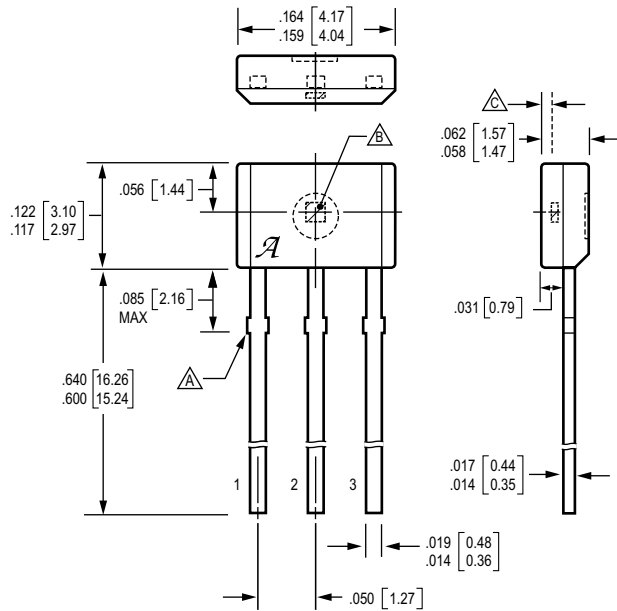

Dimensions in inches  
Metric dimensions (mm) in brackets, for reference only  
Dimensions without tolerances are basic  
▲ Dambar removal protrusion  
▲ Hall element  
▲ Active Area Depth .018 [0.46]

# A1321/A1322/A1323

## Ratiometric Linear Hall Effect Sensor for High-Temperature Operation

*The products described herein are manufactured under one or more of the following U.S. patents: 5,045,920; 5,264,783; 5,442,283; 5,389,889; 5,581,179; 5,517,112; 5,619,137; 5,621,319; 5,650,719; 5,686,894; 5,694,038; 5,729,130; 5,917,320; and other patents pending.*

*Allegro MicroSystems, Inc. reserves the right to make, from time to time, such departures from the detail specifications as may be required to permit improvements in the performance, reliability, or manufacturability of its products. Before placing an order, the user is cautioned to verify that the information being relied upon is current.*

*Allegro products are not authorized for use as critical components in life-support devices or systems without express written approval.*

*The information included herein is believed to be accurate and reliable. However, Allegro MicroSystems, Inc. assumes no responsibility for its use; nor for any infringement of patents or other rights of third parties which may result from its use.*

Copyright © 2004, Allegro MicroSystems, Inc.