

Smart Sensors

ZX Series

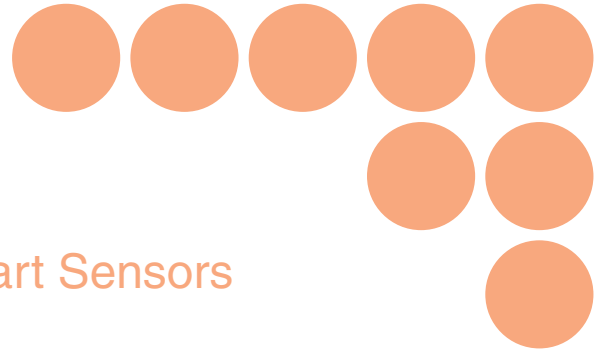

The Continuing Evolution of Smart Sensors

Presenting a New Laser-type ZX-LDA□-N Amplifier Unit

Smart Style!



Smart Style... from OMRON

I am a Smart Sensor!!



OMRON Offers Sensor Users New Choices

What's Smart?

A host of remarkable functions inside a compact body. OMRON combined these with an Amplifier display and easy operation to take Sensor detection to a whole new level. OMRON's sensing platform meets a wide range of diverse applications by offering a broad selection of heads employing different detection methods.

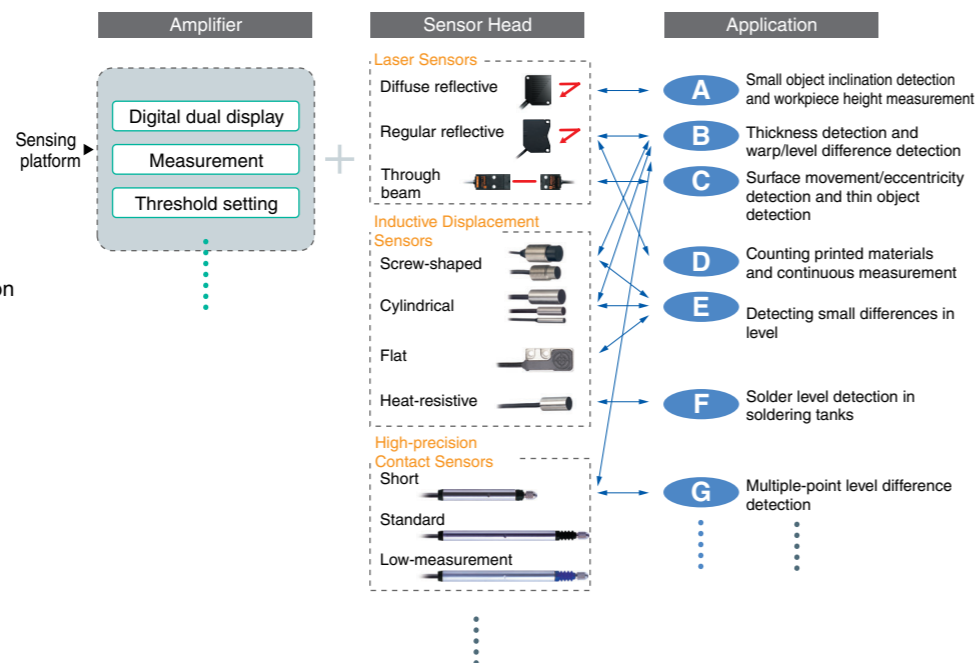

What's the Platform?

The ZX-LD-N integrates internal data for the entire ZX Series. This was achieved through technological advancements that vastly improve data communications between Amplifiers and enable calculations between different Sensor Heads. Welcome to the ever-expanding Smart World of sensing.

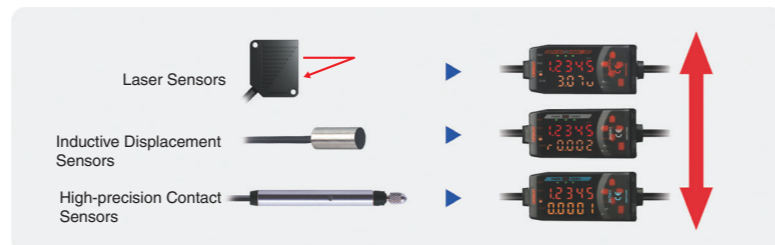

What's Style?

Top Priority Placed on Easy Operation

Advanced functions and performance plus easy operation. This is a major feature of the ZX Series. Experience operation that doesn't get any easier.

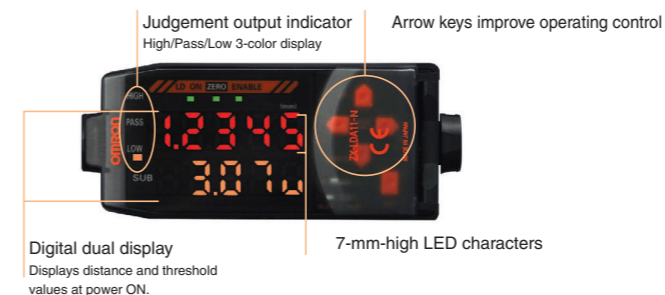

Easy-to-see Resolution Patent Pending

The resolution of the desired workpiece can also be easily determined by detection. The resolution display clearly shows the margin available for the threshold setting, to allow accurate judgement of detectability.

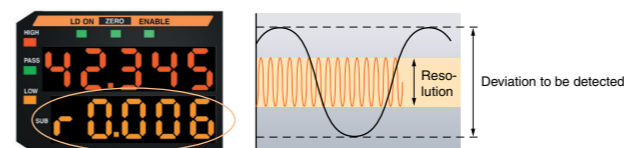

A Full Complement of Practical Functions

Operating Setting with No Need for a Digital Panel Meter Patent Pending

By simply fitting a Calculating Unit between two Amplifiers, the processing results of two Sensors can be displayed on a single Amplifier. Setting parameters need to be input only on one Amplifier.



Comprehensive Teaching Functions

Position/2-point/Automatic

Three teaching functions rival the performance of photoelectric sensors.

- Position teaching: For high-precision positioning applications
- 2-point teaching: For detecting ultra-small level differences between two points
- Automatic teaching: For teaching without stopping the workpiece

Smart Sensors Application World

Height and Level Differences	Positioning	Small Level Differences	Thickness
------------------------------	-------------	-------------------------	-----------

Semiconductors and Electronic Components

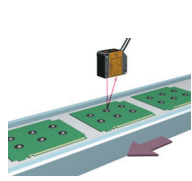

Inspecting PCB mold height

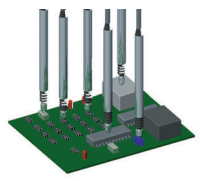

Measuring electronic component dimensions

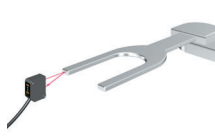

Performing shipping inspections on robot arms

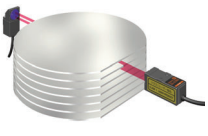

Wafer mapping (through-beam laser)

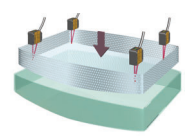

Checking CRTs for shadow mask insertion



Checking for doubled-up lead frames

Packing, Foods, Chemicals, and Sanitary Items

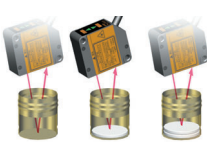

Identifying the number of inner caps for sake bottle caps

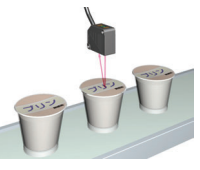

Detecting pinholes in pudding

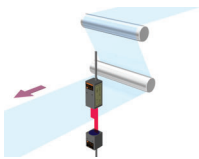

Checking the edge of transparent packing film



Detecting the indentation on glass bottles

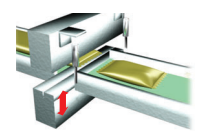

Inspecting packing machine clamps

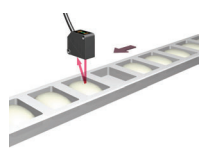

Inspecting cakes in trays for thickness and presence

Household Appliances and Office Automation



Measuring clock assembly height

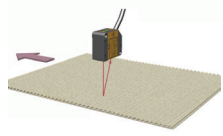

Inspecting the height of the core in cardboard

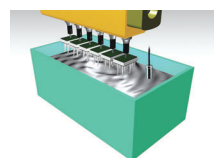

Inspecting the solder level in soldering tanks

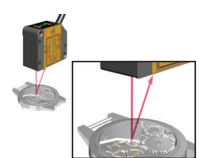

Performing final inspections during watch assembly

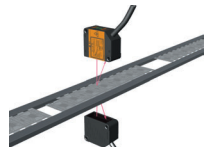

Checking the thickness of flexible items

Automobiles, Machine Tools, and Robots

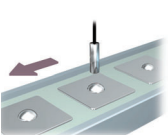

Measuring rivet height



Measuring small component dimensions

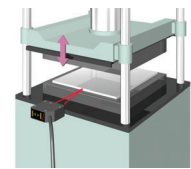

Inspecting the offset positioning of pressed workpieces

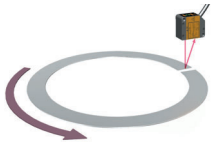

Checking welding point positions on ring gears

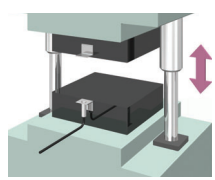

Inspecting bottom dead points on presses

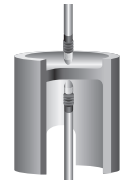

Measuring engine part dimensions

Automated Machinery, Inspection Equipment, and Others



Inspecting ball bearings for foreign matter

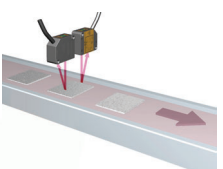

Identifying ceramic types

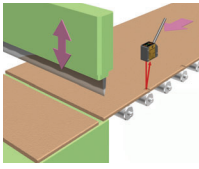

Checking cut positions on external walling material

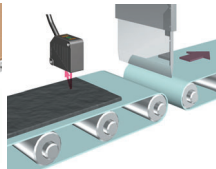

Checking rubber positioning

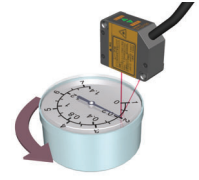

Inspecting pressure indicator dials and pointer gaps

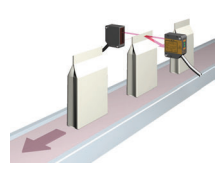

Detecting glue applied to bags

Width and Level Differences

Warp and Raised Items

Eccentricity, Surface Movement, Coating Thickness

Flatness

Counting

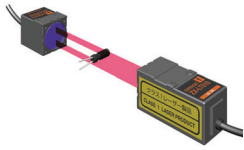

Identifying capacitor types

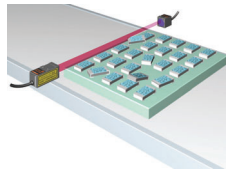

Inspecting chips for proper arrangement



Checking disc motor tables for surface movement

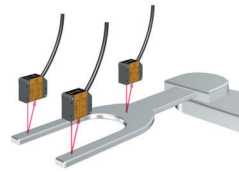

Inspecting robot arms for flatness

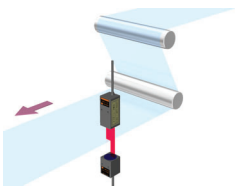

Checking the edge of transparent packing film

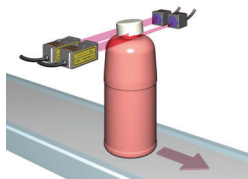

Detecting raised caps

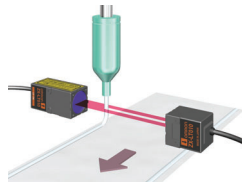

Detecting bonding agent and quantity during packing box assembly

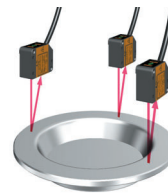

Checking the flatness of battery caps



Counting tea bags

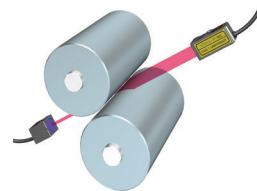

Measuring roller gap

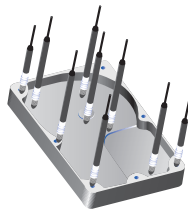

Measuring warpage of HDD chassis

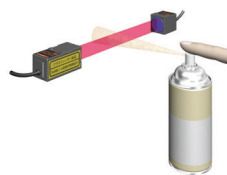

Inspecting the spray from aerosol cans

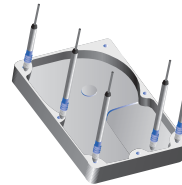

Checking the flatness of HDD chassis

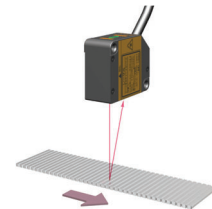

Counting copy machine staples and pins

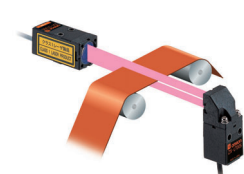

Inspecting drive belt thickness

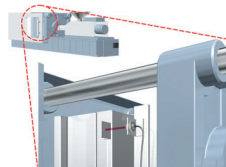

Checking dies for fit

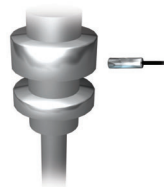

Measuring machine tool eccentricity and vibration

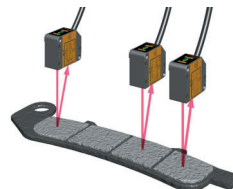

Checking the flatness of brake pads

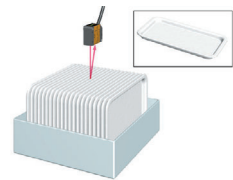

Counting containers

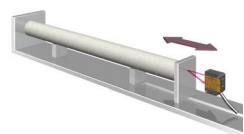

Inspecting paper tube length

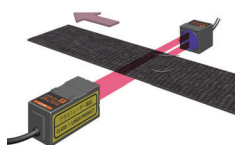

Inspecting seat belts for loose threads

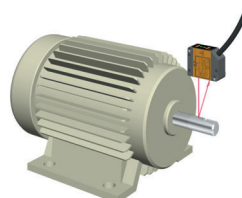

Inspecting the eccentricity of motor shafts



Inspecting steel plate surface areas

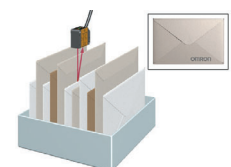

Counting envelopes

Semiconductors and Electronic Components

Packing, Foods, Chemicals, and Sanitary Items

Household Appliances and Office Automation

Automobiles, Machine Tools, and Robots

Automated Machinery, Inspection Equipment, and Others

New Sensor Proposals for IT Applications

Smart Monitor V3 NEW

PC Connection Takes Full Advantage of Sensor Performance

Use of the PC screen greatly enhances the panel display. Unlike conventional systems, the detection results from applications such as waveform monitoring and data logging can also be easily processed.



Flexible Quality Control

Data logging

The ability to log detection data and manage the system history enables efficient and effective quality control, and aides in determining necessary countermeasures. Also displays data in waveform during logging.

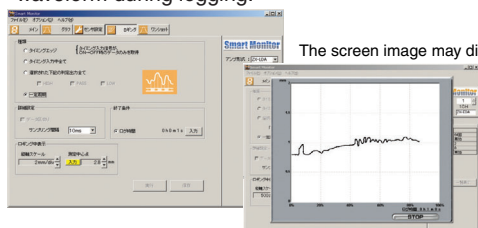

The screen image may differ from that of the actual product.

List Display Simplifies Setup

Complicated settings can be easily made with only the Amplifier panel while referring to function menus. Settings can also be imported and exported as text data.

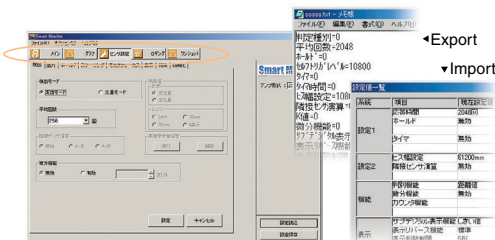

Waveform Monitoring

Easy waveform monitoring replaces the conventional oscilloscope. Drag & drop threshold setting and other easy-to-use functions further enhance operation.

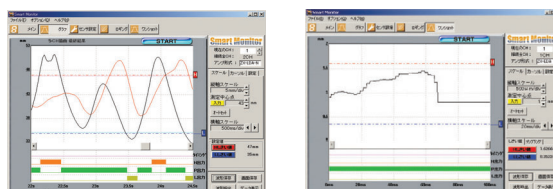

Waveform monitoring

Waveforms on up to 5 channels can be drawn with the new ZX-LDA-N.

One-shot waveform

High-speed waveforms can be obtained and displayed in one-shot operation.

PC Software Specifications

Monitoring Digital Values

- Setting differential direct threshold values
- Teaching settings

Waveform Monitoring

- Waveform collection
- Waveform observation
- Waveform saving and loading

Data Logging

- Compilation settings
- Microsoft Excel compatible (See note 2.)

Configurator Functions

- Setting Amplifier functions (actual measurement scaling, input scaling, etc.)
- Saving and loading Amplifier setting conditions

Note 1: Smart Monitor V3 is compatible with the ZX-L-N, ZX-L, ZX-E, and ZX-T.

Note 2: Microsoft Excel is a registered trademark of the Microsoft Corporation.

Note 3: System Requirements

- OS: Windows 98 or 2000
- CPU Unit: Celeron 400 MHz or better
- RAM: 64 MB min.
- Available hard disk space: 50 MB min.
- Display screen: 800 x 600 dots and 256 colors min.
- Baud rate: 38,400 bps min.

Note 4: Use an RS-232C crossover cable to connect to the computer. If the computer does not have an RS-232C port, use a USB-Serial Conversion Cable (CS1W-CF31 made by OMRON).

Contents

ZX-LDA-N Laser Sensors	8
Datasheet	12
ZX-EDA Inductive Displacement Sensors	18
Datasheet	20
ZX-TDA High-precision Contact Sensors	28
Datasheet	30
Common Precautions	35

to Smart Style

ZX-LDA-N NEW Laser Sensors

Easy as Smart Style

Advanced Functions Made Simple. That is the Essence of Smart Style.

The World's Smallest and Lightest

*As of October 1, 2001

In addition to the obvious size difference, the ZX Series offers the world's lightest Sensors. Approximately the same size as a photoelectric sensor, the compact ZX Sensors contribute considerably to space-saving efforts on production sites. Naturally, response speed is also equivalent to that of a photoelectric sensor.

*High-speed sampling: 0.15 ms (response speed: 0.3 ms)

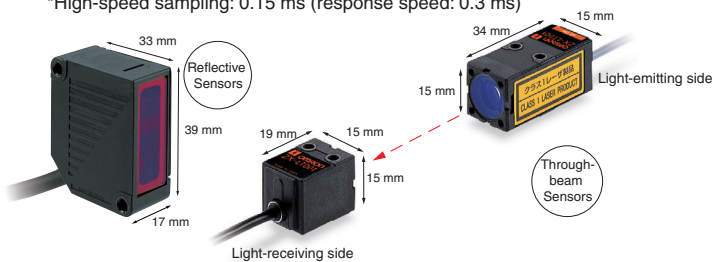

Flexible Mounting Direction

Install a Side-view Attachment (sold separately) for additional installation possibilities.

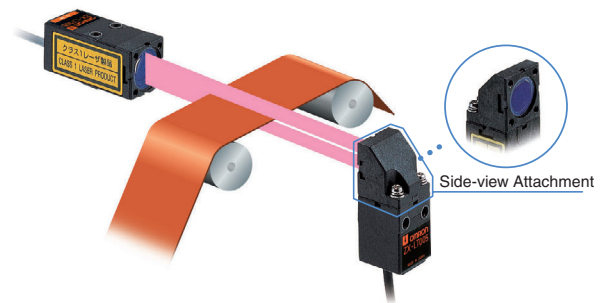

8 Reflective Types and 3 Through-beam Types Available

Reflective Sensors Class 2 visible light laser *For 4,096 sampling cycles
Select the model according to the application. Use a spot beam to detect small items, or a line beam for ordinary workpieces. Measurement distance also ranges from 28 to 500 mm, enabling seamless coverage for various detection applications.

Spot form
Two-spot Sensors

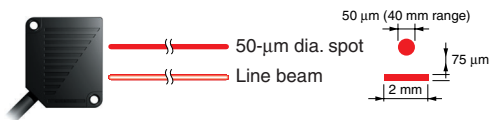

Distance range (resolution)

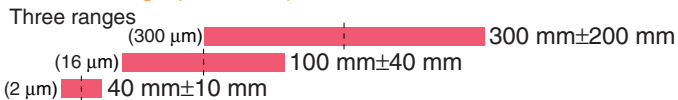

Through-beam Sensors Class 1 visible light laser *For 64 sampling cycles
Use a 1-mm-dia. spot for precise positioning, or a 5- to 10-mm-wide screen beam for area detection.

Measuring width and distance range (4-μm resolution)

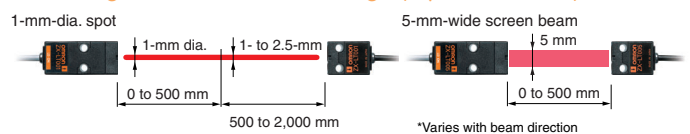

Regular reflection (displacement) Class 2 visible light laser
Ideal for detecting mirror surfaces.
Distance range (0.25 μm resolution) One range
Spot form Two-spot Sensors

Diagram showing a sensor with dimensions 45 mm (width) and 55 mm (height). The distance range is 30 mm ± 2 mm. Spot form dimensions are 75 μm (width) and 100 μm (height), with a 1.8 mm diameter for the two-spot sensors.



Light-intensity Mode: High-performance Laser Photoelectric Sensor

Reflective Sensors

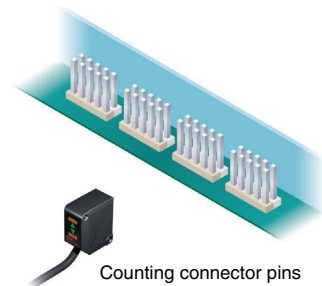

Light-intensity Mode: High-performance Laser Photoelectric Sensor

Light intensity can be detected by the ultra-small spot of the laser beam. By operating as a high-precision laser photoelectric sensor, rather than a displacement meter, this enables detection of small items with backgrounds, as well as color detection. Ideal function settings are possible by using both the displacement mode and the light-intensity mode to meet multiple application needs.

Through-beam Sensors

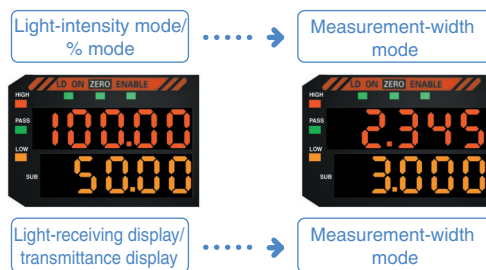

Equipped with a Laser Lifetime Monitor

Self-detection and Display of Laser Diode Lifetime

When laser diode deterioration is detected, a warning appears on the sub-digital display. Early detection enables timely, trouble-free replacement.



ZX-LDA-N



to **Smart Digital**

ZX-LDA-N NEW New Laser Type

Advanced **to Smart Digital**

Advanced Functions Respond to Evolving Needs

More User Friendly New Function

Zero Reset Time Display

A reference value other than zero can be set as the zero reset value.



Present Value Display

The sub-digital display shows present values when the hold function is enabled. This makes it easy to check whether a measurement is within range.



Linear Output Correction

Various factors, such as conversion errors occurring with connected devices, may cause the output value displayed on the Amplifier to differ from the actual output from a voltmeter. Adjusting the Amplifier display while monitoring the actual output on a voltmeter can eliminate the difference between the two values.

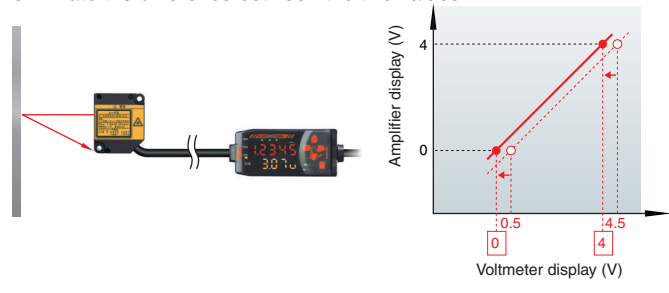

Automatic Teaching

Maximum and minimum measurement values can be set as thresholds when automatic teaching is executed. It is useful for setting threshold values from actual measurements while the workpiece is moving.

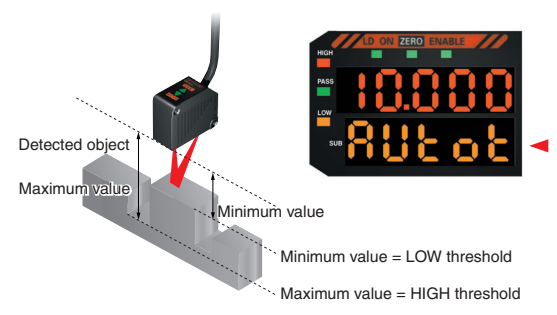

Enhanced Hold Function New Function

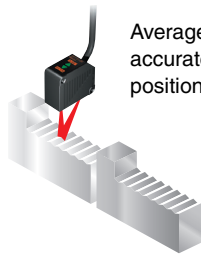

Average hold and delay hold functions were added to enable accurate assessment of changes and the desired measurement position.

Delay Hold/Average Hold

The delay hold function measures only signals within the desired sampling time after a specified time delay from the trigger. The newly added average hold function is especially useful for measuring large workpieces with uneven surfaces.

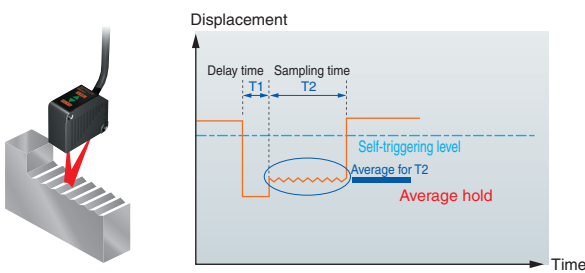

Previous Value Comparison Function

Gradual changes in measurements due to machine temperature changes or other factors can be ignored in certain situations, such as when detecting foreign matter around bearings. The previous value comparison function effectively detects any changes between previous and present values.

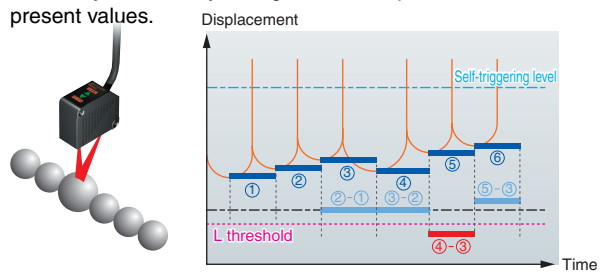

Multiple-point Measurements Computed Using 1 Point

The result computed for one point can be used as a basis for the output for every other point. This is especially useful for multiple-point measurements.

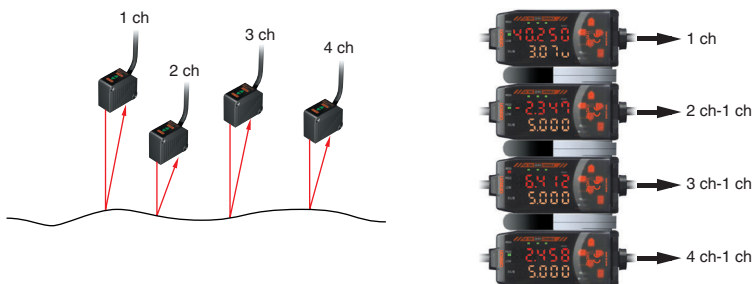

ZX-LDA-N



Ordering Information

■ Sensors

Sensor Heads (Reflective)

Optical system	Beam shape	Sensing distance	Resolution*	Model
Diffuse reflective	Spot beam	40±10 mm	2 μm	ZX-LD40
		100±40 mm	16 μm	ZX-LD100
		300±200 mm	300 μm	ZX-LD300
	Line beam	40±10 mm	2 μm	ZX-LD40L
		100±40 mm	16 μm	ZX-LD100L
		300±200 mm	300 μm	ZX-LD300L
Regular reflective	Spot beam	30±2 mm	0.25 μm	ZX-LD30V
	Line beam			ZX-LD30VL

* For an average count of 4,096.

Sensor Heads (Through-beam)

Optical system	Measuring width	Sensing distance	Resolution*	Model
Through-beam	1-mm dia.	0 to 2000 mm	4 μm	ZX-LT001
	5 mm	0 to 500 mm		ZX-LT005
	10 mm			ZX-LT010

* For an average count of 64.

Amplifier Units

Appearance	Power supply	Output type	Model
	DC	NPN	ZX-LDA11-N
		PNP	ZX-LDA41-N

Note: Compatible connection with the Sensor Head.

Accessories (Order Separately)

Calculating Unit

Appearance	Model
	ZX-CAL2

Side-view Attachments

Appearance	Applicable Sensor Head	Model
	ZX-LT1001/ LT005	ZX-XF12
	ZX-LT010	ZX-XF22



Cables with Connectors on Both Ends (for Extension)*1

Cable length	Model	Quantity
1 m	ZX-XC1A	1
4 m	ZX-XC4A	
8 m	ZX-XC8A	
9 m *2	ZX-XC9A	

*1. ZX-XC□R robot cable type also available.

*2. For use only with Reflective Sensors.

Smart Monitor Sensor Setup Tool for Personal Computer Connection

Appearance	Name	Model
	ZX-series Communications Interface Unit	ZX-SF11
	ZX-series Communications Interface Unit + ZX-series Sensor Setup Software Basic	ZX-SFW11V3 *1, *2
CD-ROM	ZX-series Sensor Setup Software	ZX-SW11EV3 *1

*1. The ZX-SFW11V3 or ZX-SW11V3 is required to use Smart Monitor with the ZX-LDA11-N/41-N. Earlier versions cannot be used.

*2. The ZX-SFW11EV3 SmartMonitor can be used only to set functions and monitor waveforms.

Specifications

■ Sensor Heads (Reflective)

Item	Model	ZX-LD40	ZX-LD100	ZX-LD300	ZX-LD30V	ZX-LD40L	ZX-LD100L	ZX-LD300L	Z3X-LD30VL
Optical system		Diffuse reflective			Regular reflective	Diffuse reflective			Regular reflective
Light source (wave length)		Visible-light semiconductor laser with a wavelength of 650 nm and an output of 1 mW max.; class 2							
Measurement point		40 mm	100 mm	300 mm	30 mm	40 mm	100 mm	300 mm	30 mm
Measurement range		±10 mm	±40 mm	±200 mm	±2 mm	±10 mm	±40 mm	±200 mm	±2 mm
Beam shape		Spot				Line			
Beam size*1		50-μm dia.	100-μm dia.	300-μm dia.	75-μm dia.	75 μm x 2 mm	150 μm x 2 mm	450 μm x 2 mm	100 μm x 1.8 mm
Resolution*2		2 μm	16 μm	300 μm	0.25 μm	2 μm	16 μm	300 μm	0.25 μm
Linearity*3		±0.2% FS (entire range)	±0.2% FS (80 to 120 mm)	±2% FS (200 to 400 mm)	±0.2% FS (entire range)	±0.2% FS (32 to 48 mm)	±0.2% FS (80 to 120 mm)	±2% FS (200 to 400 mm)	±0.2% FS (entire range)
Temperature characteristic*4		±0.03% FS/°C (Except for ZX-LD300 and ZX-LD300L, which are ±0.1% FS/°C.)							
Ambient illumination		Incandescent lamp: 3,000 lx max. (on light receiving side)							
Ambient temperature		Operating: 0 to 50°C, Storage: -15 to 60°C (with no icing or condensation)							
Ambient humidity		Operating and storage: 35% to 85% (with no condensation)							
Insulation resistance		20 MΩ min. at 500 VDC							
Dielectric strength		1,000 VAC, 50/60 Hz for 1 min							
Vibration resistance (destruction)		10 to 150 Hz, 0.7-mm double amplitude 80 min each in X, Y, and Z directions							
Shock resistance (destruction)		300 m/s ² 3 times each in six directions (up/down, left/right, forward/backward)							
Degree of protection		IEC60529, IP50			IEC60529, IP40	IEC60529, IP50			IEC60529, IP40
Connection method		Connector relay (standard cable length: 500 mm)							
Weight (packed state)		Approx. 150 g			Approx. 250 g	Approx. 150 g			Approx. 250 g
Materials		Case: PBT (polybutylene terephthalate), Cover: Aluminum, Lens: Glass			Case and cover: Aluminum, Lens: Glass	Case: PBT (polybutylene terephthalate), Cover: Aluminum, Lens: Glass			Case and cover: Aluminum, Lens: Glass
Accessories		Instruction sheet, Laser warning label (English)							

- *1. Beam size: The beam size is defined by 1/e² (13.5%) of the strength of the beam at the beam center (measured value). Incorrect detection may occur if there is light leakage outside the defined spot and the material around the sensing object is more reflective than the sensing object.
- *2. Resolution: The resolution is the deviation (±3σ) in the linear output when connected to the ZX-LDA Amplifier Unit. (The resolution is measured with the standard reference object (white ceramic), at the measurement point with the ZX-LDA set for an average count of 4,096 per period.) The resolution is given at the repeat accuracy for a stationary workpiece, and is not an indication of the distance accuracy. The resolution may be adversely affected under strong electromagnetic fields.
- *3. Linearity: The linearity is given as the error in an ideal straight line displacement output when measuring the standard reference object. The linearity and measurement values vary with the object being measured.
- *4. Temperature characteristic: The temperature characteristic is measured at the measurement point with the Sensor and reference object (OMRON's standard reference object) secured with an aluminum jig.

Note: Highly reflective objects can result in incorrect detection by causing out-of-range measurements.

■ Sensor Heads (Through-beam)

Item	Model	ZX-LT001	ZX-LT005	ZX-LT010
Optical system		Through-beam		
Light source (wave length)		Visible-light semiconductor laser with a wavelength of 650 nm; JIS class1		
Maximum output		0.2 mW max.	0.35 mW max.	
Measurement width		1-mm dia.	1- to 2.5-mm dia.	5 mm, 10 mm
Measurement distance		0 to 500 mm	500 to 2,000 mm	0 to 500 mm
Minimum sensing object		8-μm dia. (opaque)	8- to 50-μm dia. (opaque)	0.05-mm dia. (opaque), 0.1-mm dia. (opaque)
Resolution*1		4 μm *2	---	4 μm *3
Temperature characteristic		0.2% FS/°C		
Ambient illumination		Incandescent lamp: 10,000 lx max. (on light-receiving side)		
Ambient temperature		Operating: 0 to 50°C, Storage: -25 to 70°C (with no icing or condensation)		
Degree of protection		IEC60529, IP40		
Connection method		Connector relay (standard cable length: 500 mm)		
Weight (packed state)		Approx. 220 g		
Cable length		Extendable up to 10 m with special extension cable.		
Materials		Case: Polyetherimide, Case cover: Polycarbonate, Unit cover: Glass		
Tightening torque		0.3 N·m max.		
Accessories		Optical axis adjustment seal, sensor head-amplifier connection cable (1.5 m), instruction sheet		

- *1. This value is obtained by converting the deviation (±3σ) in the linear output that results when the sensor head is connected to the amplifier unit, into the measurement width.
- *2. For an average count of 64. The value is 5 μm for an average count of 32. This is the value that results when a minimum sensing object blocks the light near the center of the 1-mm measurement width.
- *3. For an average count of 64. The value is 5 μm for an average count of 32.

■ Amplifier Units

Item	Model	ZX-LDA11-N	ZX-LDA41-N
Measurement period		150 μs	
Possible average count settings*1		1, 2, 4, 8, 16, 32, 64, 128, 256, 512, 1,024, 2,048, or 4,096	
Temperature characteristic		When connected to a Reflective Sensor Head: 0.01% FS/°C, When connected to a Through-beam Sensor Head: 0.1% FS/°C	
Linear output*2		4 to 20 mA/FS, Max. load resistance: 300 Ω, ±4 V (± 5 V, 1 to 5 V *3), Output impedance: 100 Ω	
Judgement outputs (3 outputs: HIGH/PASS/LOW)*1		NPN open-collector outputs, 30 VDC, 50 mA max. Residual voltage: 1.2 V max.	PNP open-collector outputs, 30 VDC, 50 mA max. Residual voltage: 2 V max.
Laser OFF input, zero reset input, timing input, reset input		ON: Short-circuited with 0-V terminal or 1.5 V or less OFF: Open (leakage current: 0.1 mA max.)	ON: Supply voltage short-circuited or supply voltage within 1.5 V OFF: Open (leakage current: 0.1 mA max.)
Functions		Measurement value display, set value/light level/resolution display, scaling, display reverse, display OFF mode, ECO mode, number of display digit changes, sample hold, peak hold, bottom hold, peak-to-peak hold, self-peak hold, self-bottom hold, intensity mode, zero reset, initial reset, ON-delay timer, OFF-delay timer, one-shot timer, deviation, previous value comparison, sensitivity adjustment, keep/clamp switch, direct threshold value setting, position teaching, 2-point teaching, automatic teaching, hysteresis width setting, timing inputs, reset input, monitor focus, (A-B) calculations*4, (A+B) calculations*4, mutual interference*4, laser deterioration detection, zero reset memory, key lock	
Indications		Operation indicators: High (orange), pass (green), low (yellow), 7-segment main display (red), 7-segment subdisplay (yellow), laser ON (green), zero reset (green), enable (green)	
Power supply voltage		12 to 24 VDC ±10%, Ripple (p-p): 10% max.	
Current consumption		140 mA max. with power supply voltage of 24 VDC (with Sensor connected)	
Ambient temperature		Operating: 0 to 50°C, Storage: -15 to 60°C (with no icing or condensation)	
Ambient humidity		Operating and storage: 35% to 85% (with no condensation)	
Insulation resistance		20 MΩ min. at 500 VDC	
Dielectric strength		1,000 VAC, 50/60 Hz for 1 min	
Vibration resistance (destruction)		10 to 150 Hz, 0.7-mm double amplitude 80 min each in X, Y, and Z directions	
Shock resistance (destruction)		300 m/s ² 3 times each in six directions (up/down, left/right, forward/backward)	
Connection method		Prewired (standard cable length: 2 m)	
Weight (packed state)		Approx. 350 g	
Materials		Case: PBT (polybutylene terephthalate), Cover: Polycarbonate	
Accessories		Instruction sheet	

- *1. The response speed of the linear output is calculated as the measurement period × (average count setting + 1) (with fixed sensitivity).
The response speed of the judgement outputs is calculated as the measurement period × (average count setting + 1) (with fixed sensitivity).
- *2. The output can be switched between a current output and voltage output using a switch on the bottom of the Amplifier Unit.
- *3. Setting is possible via the monitor focus function.
- *4. A Calculating Unit (ZX-CAL2) is required.

Note: For operating details, refer to the operation manual (Cat. No. Z157).

■ Calculating Unit

Item	ZX-CAL2
Applicable Amplifier Units	ZX-LD11-N/41-N, ZX-EDA11/41, ZX-TDA11/41
Current consumption	12 mA max. (supplied from the Smart Sensor Amplifier Unit)
Ambient temperature	Operating: 0 to 50°C, Storage: -15 to 60°C (with no icing or condensation)
Ambient humidity	Operating and storage: 35% to 85% (with no condensation)
Connection method	Connector
Dielectric strength	1,000 VAC, 50/60 Hz for 1 min
Insulation resistance	100 MΩ (at 500 VDC)
Vibration resistance (destructive)	10 to 150 Hz, 0.7-mm double amplitude 80 min each in X, Y, and Z directions
Shock resistance (destructive)	300 m/s ² 3 times each in six directions (up/down, left/right, forward/backward)
Materials	Display: Acrylic, Case: ABS resin
Weight (packed state)	Approx. 50 g
Accessories	Instruction sheet

■ ZX-series Communications Interface Unit

Item	ZX-SF11	
Current consumption	60 mA max. (supplied by the Amplifier Unit)	
Applicable Amplifier Units	ZX Series	
Applicable Amplifier Unit versions	ZX-LDA□1-N Ver. 1.000 or higher ZX-EDA□1 Ver. 1.100 or higher ZX-TDA□1 Ver. 1.000 or higher	
Max. No. of Amplifier Units	5	
Communications functions	Communications port	RS-232C port (9-pin D-Sub Connector)
	Communications protocol	CompoWay/F*
	Baud rate	38,400 bps
Data configuration	Data bits: 8, Parity: none, Start bits: 1, Stop bits: 1, Flow control: none	
Indicators	Power supply: green, Sensor communications: green, Sensor communications error: red, External terminal communications: green, External terminal communications error: red	
Protective circuits	Reverse polarity protection	
Ambient temperature	Operating: 0 to 50°C, storage: -15 to 60°C (with no icing or condensation)	
Ambient humidity	Operating and storage: 35% to 85% (with no condensation)	
Insulation resistance	20 MΩ min. (at 500 VDC)	
Dielectric strength	1,000 VAC, 50/60 Hz for 1 min, Leakage current: 10 mA max.	
Materials	Case: PBT (polybutylene terephthalate), Cover: Polycarbonate	
Accessories	Instruction sheet, 2 clamps	

* Contact your OMRON representative for CompoWay/F communications specifications.

Dimensions

(Unit: mm)

■ Sensor Heads (Diffuse Reflective)

- ZX-LD40
- ZX-LD100
- ZX-LD300
- ZX-LD40L
- ZX-LD100L
- ZX-LD300L

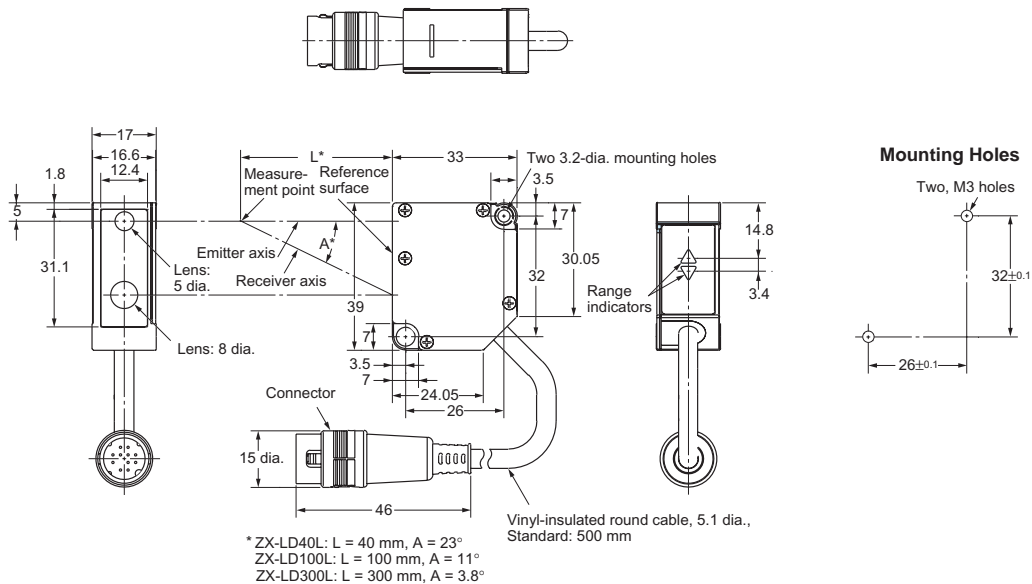

■ Sensor Heads (Regular Reflective)

- ZX-LD30V
- ZX-LD30VL

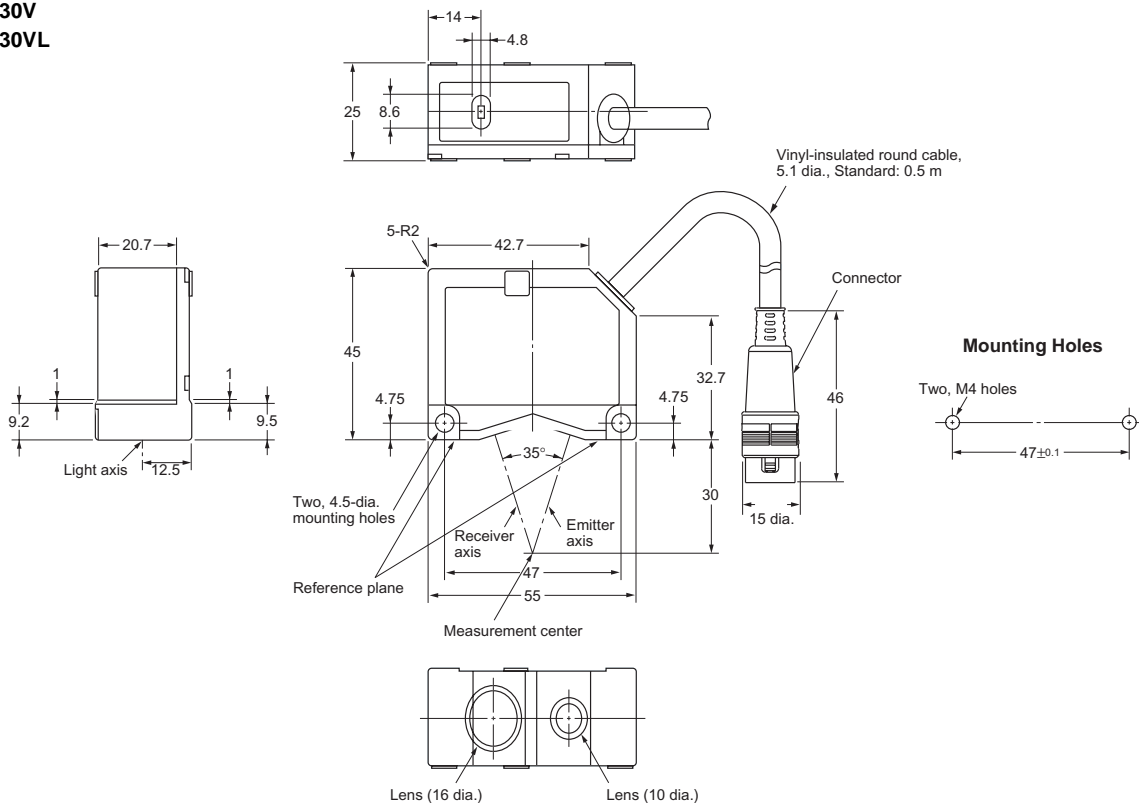

■ Sensor Heads (Through-beam)

ZX-LT001

ZX-LT005

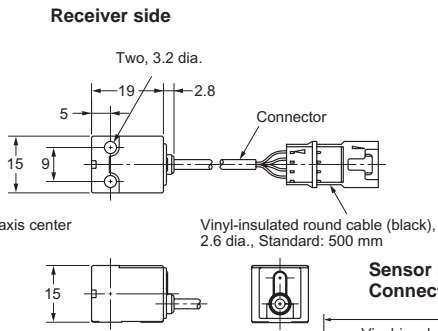
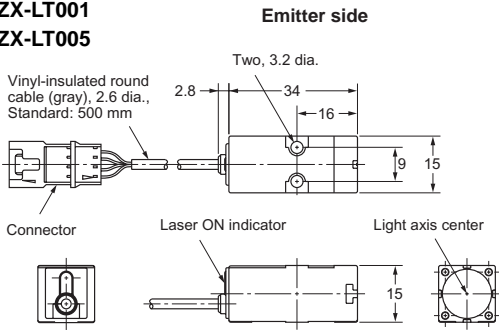

Mounting Holes

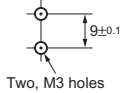

Mounting Holes

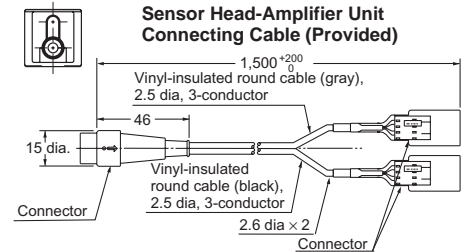
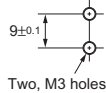

ZX-LT010

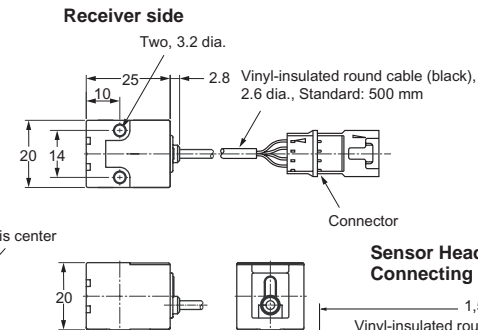
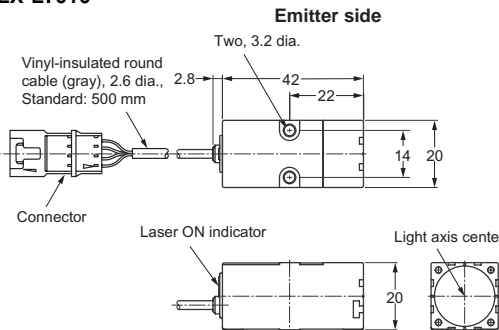

Mounting Holes

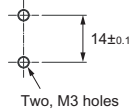

Mounting Holes

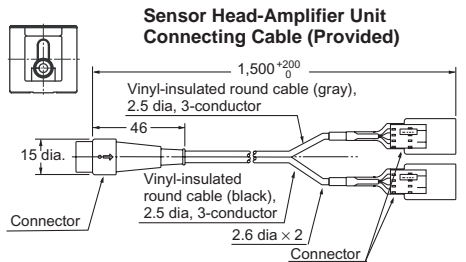
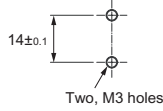

■ Amplifier Units

ZX-LDA11-N

ZX-LDA41-N

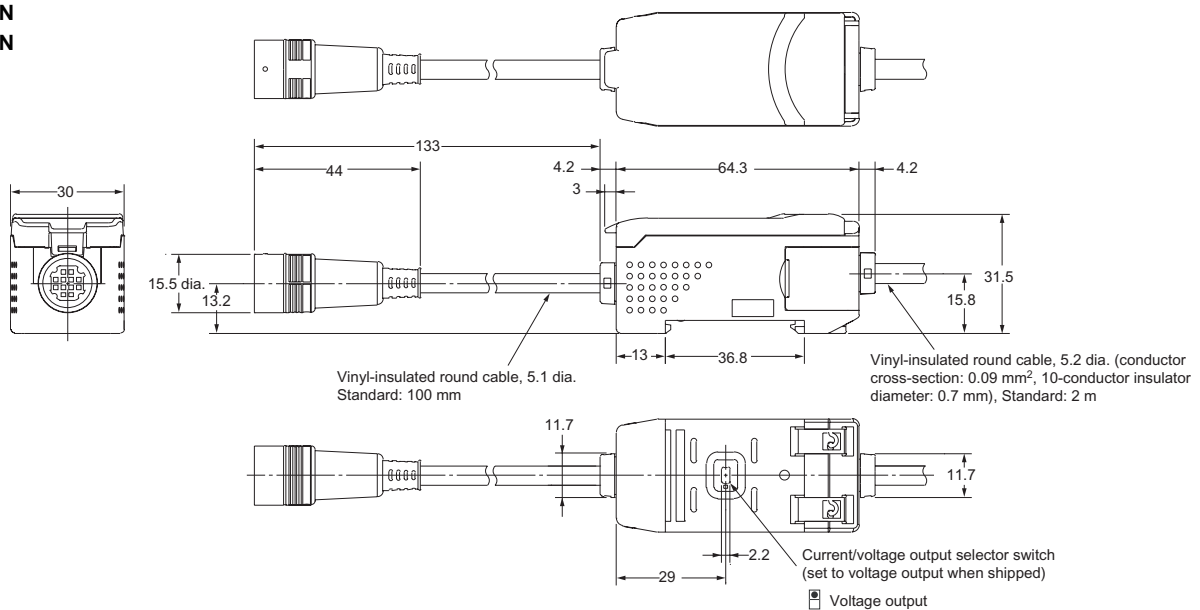

Accessories (Order Separately)

Calculating Unit ZX-CAL2

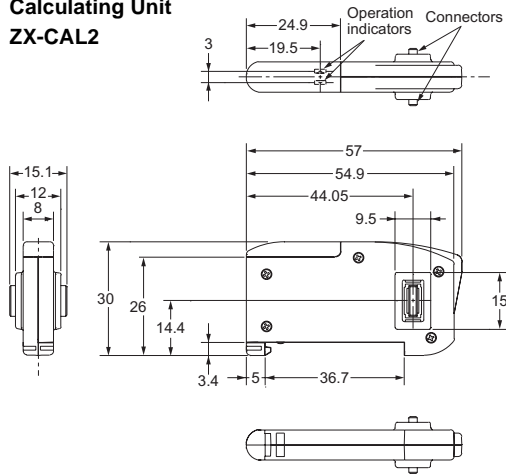

Side-view Attachments ZX-XF12

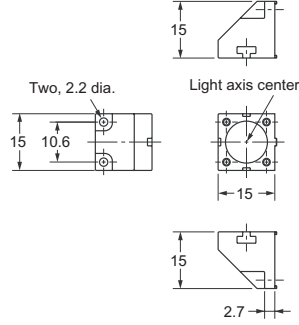

ZX-XF22

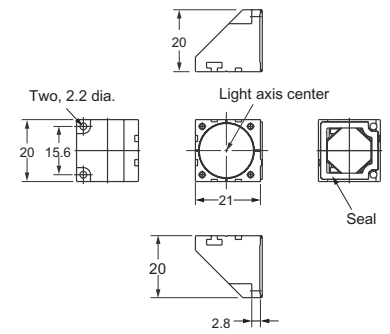

ZX-series Communications Interface Unit ZX-SF11

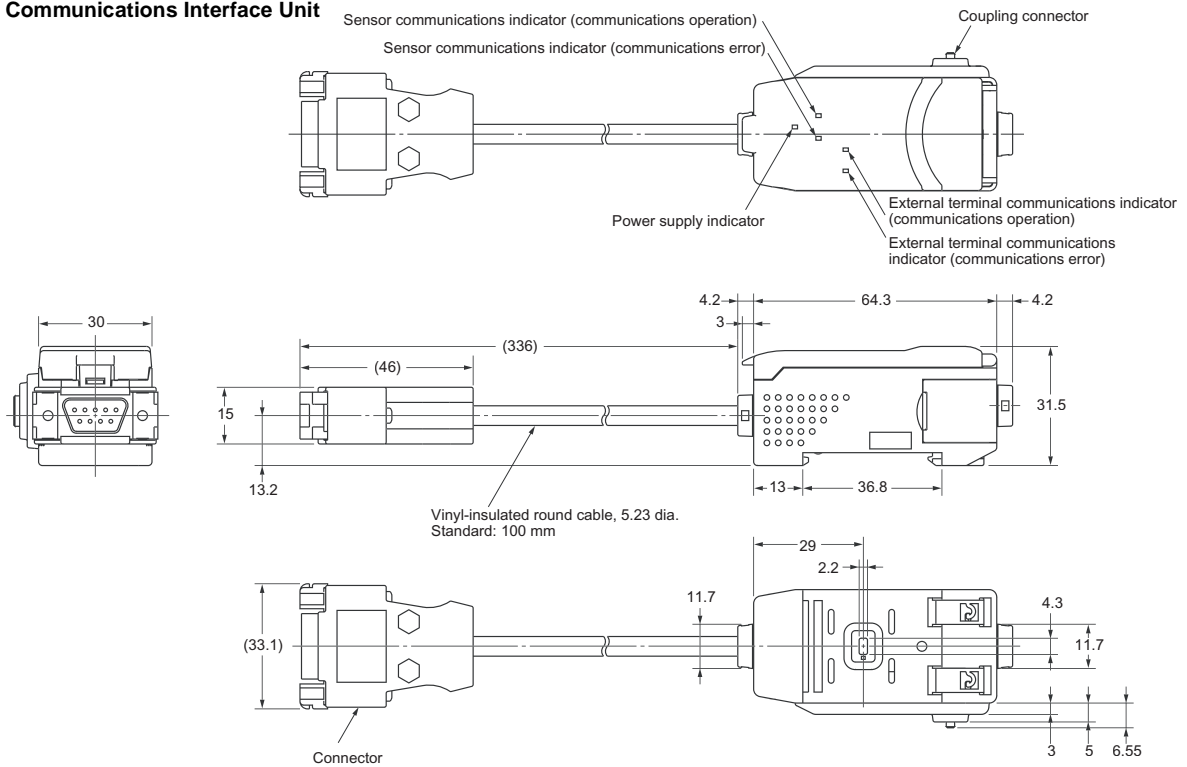

Cables with Connectors on Both Ends (for Extension)

- ZX-XC1A (1 m)
- ZX-XC4A (4 m)
- ZX-XC8A (8 m)
- ZX-XC9A (9 m)*1

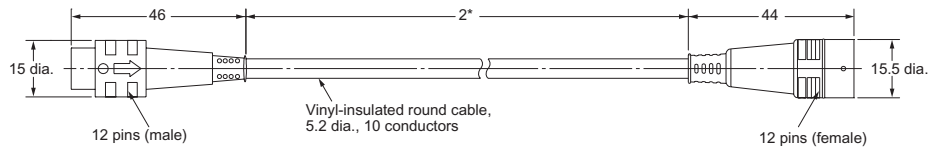

*1 For use only with the ZX-L.

*2 ZX-XC1A: 1,000
ZX-XC4A: 4,000
ZX-XC8A: 8,000
ZX-XC9A: 9,000

ZX-EDA Inductive Displacement Sensors

Variation for Smart Edge

Inductive Displacement Sensors for Even More Applications

Wide Selection of Sensor Heads

Smallest Heads in Its Class at 3 Dia.

Small Sensor Heads are perfect for detecting the height of small objects and for applications where multiple Sensor Heads are used.



Sensors with stainless steel Protective Spiral Tubes are also available.



New Flat and Heat-resistive Sensors Broaden Application Possibilities

The temperature characteristic ranks at the top in the industry at 0.1% FS/°C for heat-resistive sensors, and it ranges up to 200°C for flat sensors.



More Efficient Maintenance

Complete Compatibility between Sensor Heads and Amplifier Units

The Amplifier Unit can be used as is when replacing damaged Sensor Heads or changing the Sensor Head for different detection distances.



Sensor Head Cords Extendable to 10 m

The distance between the Amplifier Units the Sensor Heads can be extended to 3 m, 6 m, or 10 m using a ZX-XC□A Cable (sold separately).

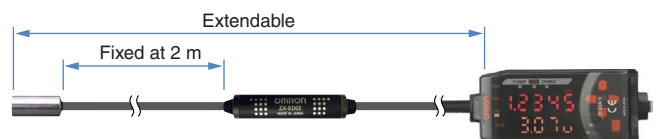

Complete Range of Useful Functions

Simple Linearity Adjustment Patent Pending

Adjustments using the adjustment knob are no longer required to adjust linearity.

Linearity adjustment is completed simply by teaching at 0%, 50%, and 100% of the measurement distance, greatly reducing setting time.

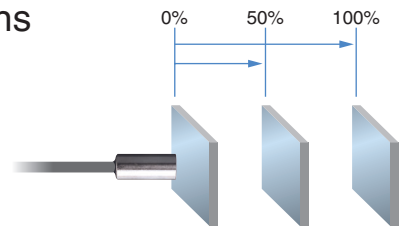

Suitable for Non-ferrous Metals Also

Linearity is worse for non-ferrous than ferrous sensing objects. A material selection function has been developed to improve linearity with stainless steel and aluminum sensing objects.

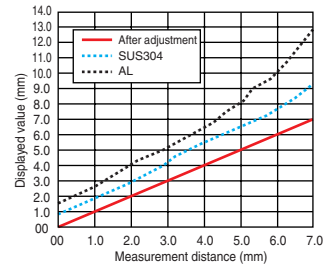

Mutual Interference Prevented for Up to 5 Sensors

Multiple Sensors may be used in confined spaces for level difference measurements or multiple-point measurements. Mutual interference between up to 5 Sensors can be prevented simply by connecting Calculating Units to eliminate the need for timing signals on the user side.

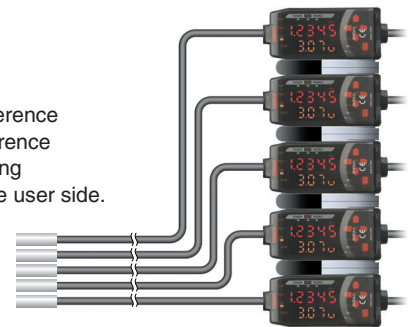

Calculation Settings without Digital Panel Data Patent Pending

The calculation results from two Sensors can be displayed on the Amplifier for one Sensor simply by placing a Calculating Unit between the Amplifier Units. The required parameters need to be input only into one Amplifier Unit.

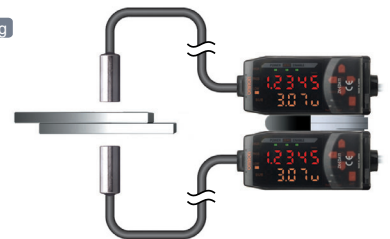

ZX-EDA



Ordering Information

■ Sensors

Sensor Heads

Shape	Dimensions	Sensing distance	Resolution *1	Model
Cylindrical	3 dia. x 18 mm	0.5 mm	1 μm	ZX-EDR5T
	5.4 dia. x 18 mm	1 mm		ZX-ED01T *2
	8 dia. x 22 mm	2 mm		ZX-ED02T *2
Screw-shaped	M10 x 22 mm			ZX-EM02T *2
	M18 x 46.3 mm	7 mm		ZX-EM07MT *2
Flat	30 x 14 x 4.8 mm	4 mm		ZX-EV04T *2 *3
Heat-resistant, cylindrical	M12 x 22 mm	2 mm	ZX-EM02HT *4	

*1. For an average count of 4096.

*2. Models with Protective Spiral Tubes are also available. Add a suffix of “-S” to the above model numbers when ordering.
(Example: ZX-ED01-S)

*3. Be sure to use ZX-EDA□ Amplifier Unit version 1,200 or later with the ZX-EV04T.

*4. Be sure to use ZX-EDA□ Amplifier Unit version 1,300 or later with the ZX-EM02HT.



Amplifier Units

Appearance	Power supply	Output type	Model
	DC	NPN	ZX-EDA11
		PNP	ZX-EDA41

Note: Compatible connection with the Sensor Head.

Accessories (Order Separately)

Amplifier Mounting Brackets

Appearance	Model	Remarks
	ZX-XBE1	Attached to each Sensor Head
	ZX-XBE2	For DIN track mounting

ZX-CAL2 Calculating Unit

Refer to pages 12 and 14 for details.

ZX-SF11 ZX-series Communications Interface Unit

Refer to pages 12 and 14 for details.

ZX-XC□A Cable with Connectors on Both Ends (for Extension)

Refer to page 12 for details.

ZX-SW11V3 Smart Monitor Sensor Setup Tool for Personal Computer Connection

Refer to page 12 for details.

Specifications

■ Sensor Heads

Model		ZX-EDR5T	ZX-ED01T	ZX-ED02T/ EM02T	ZX-EM07MT	ZX-EV04T	ZX-EM02HT	
Measurement range		0 to 0.5 mm	0 to 1 mm	0 to 2 mm	0 to 7 mm	0 to 4 mm	0 to 2 mm	
Sensing object		Magnetic metals (Measurement ranges and linearities are different for non-magnetic metals.)						
Standard reference object		18 × 18 × 3 mm		30 × 30 × 3 mm	60 × 60 × 3 mm		45 × 45 × 3 mm	
		Material: ferrous (S50C)						
Resolution *1		1 μm						
Linearity *2		±0.5% F.S.					±1.0% F.S. *5	
Linear output range		Same as measurement range.						
Temperature characteristic *3 (including Amplifier Unit)		0.15% F.S./°C		0.07% F.S./°C			0.1% F.S./°C	
Ambient temperature	Operating *4	0 to 50°C (with no icing or condensation)		-10 to 60°C (with no icing or condensation)			-10 to 200°C	
	Storage *4	-20 to 70°C (with no icing or condensation)		-20 to 70°C (with no icing or condensation)			-20 to 200°C	
Ambient humidity		Operating and storage: 35% to 85% (with no condensation)						
Insulation resistance		50 MΩ min. (at 500 DC)						
Dielectric strength		1,000 VAC, 50/60 Hz for 1 min between charged parts and case						
Vibration resistance (destruction)		10 to 55 Hz with 1.5-mm double amplitude for 2 h each in X, Y, and Z directions						
Shock resistance (destruction)		500 m/s ² , 3 times each in X, Y, and Z directions						
Degree of protection (Sensor Head)		IEC60529, IP65		IEC60529, IP67			IEC60529, IP60 *6	
Connection method		Connector relay (standard cable length: 2 m)						
Weight (packed state)		Approx. 120 g		Approx. 140 g		Approx. 160 g	Approx. 130 g	Approx. 160 g
Materials	Sensor Head	Brass		Stainless steel		Brass	Zinc (nickel-plated)	Brass
	Sensing surface	Heat-resistant ABS						PEEK
	Preamplifier	PES						
Accessories		Amplifier Mounting Brackets (ZX-XBE1), Instruction Manual						

*1. Resolution: The resolution is the deviation (±3 s) in the linear output when connected to the ZX-EDA Amplifier Unit. The above values indicate the deviations observed 30 minutes after the power is turned ON.

(The resolution is measured with OMRON's standard reference object at 1/2 of the measurement range with the ZX-EDA set for the maximum average count of 4096.)

The resolution is given at the repeat accuracy for a stationary workpiece, and is not an indication of the distance accuracy. The resolution may be adversely affected under strong electromagnetic fields.

*2. Linearity: The linearity is given as the error in an ideal straight line displacement output when measuring the standard reference object. The linearity and measurement values vary with the object being measured.

*3. Temperature characteristic: The temperature characteristic is measured with OMRON's standard reference object at 1/2 of the measurement range.

*4. The ambient temperature given is only for the sensor head. It is -10 to 60°C for the preamp.

*5. The value given is for an ambient temperature of 25°C.

*6. Do not use in moist environments because the case is not waterproof.

■ Amplifier Units

Model	ZX-EDA11	ZX-EDA41
Measurement period	150 μs	
Possible average count settings *1	1, 2, 4, 8, 16, 32, 64, 128, 256, 512, 1,024, 2,048, or 4,096	
Linear output *2	Current output: 4 to 20 mA/F.S., Max. load resistance: 300 Ω Voltage output: ±4 V (± 5 V, 1 to 5 V *3), Output impedance: 100 Ω	
Judgement outputs (3 outputs: HIGH/PASS/LOW)	NPN open-collector outputs, 30 VDC, 50 mA max. Residual voltage: 1.2 V max.	PNP open-collector outputs, 30 VDC, 50 mA max. Residual voltage: 2 V max.
Zero reset input, timing input, reset input, judgement output hold input	ON: Short-circuited with 0-V terminal or 1.5 V or less OFF: Open (leakage current: 0.1 mA max.)	ON: Supply voltage short-circuited or supply voltage within 1.5 V OFF: Open (leakage current: 0.1 mA max.)
Function	<ul style="list-style-type: none"> - Measurement value display - Linearity adjustment (materials selection) - Display reverse - Number of display digit changes - Bottom hold, peak-to-peak hold - Average hold - Initial reset - OFF-delay timer - Non-measurement setting - Automatic teaching - Reset input - Linear output correction - K-(A+B) calculation *4 - Sensor disconnection detection - Key lock - Present value/set value/output value/resolution display - Scaling - Display OFF mode - Sample hold - Self-peak hold - Delay hold - Linearity initialization - One-shot timer - Direct threshold value setting - Hysteresis width setting - Judgement output hold input - (A-B) calculations *4 - Mutual interference prevention *4 - Zero reset memory - ECO mode - Peak hold - Self-bottom hold - Zero reset - ON-delay timer - Previous value comparison - Position teaching - Timing inputs - Monitor focus - (A+B) calculations *4 - Zero reset indicator 	
Indications	Judgement indicators: High (orange), pass (green), low (yellow), 7-segment main digital display (red), 7-segment sub-digital display (yellow), power ON (green), zero reset (green), enable (green)	
Voltage influence (including Sensor)	0.5% F.S. of linear output value at ±20% of power supply voltage	
Power supply voltage	12 to 24 VDC ±10%, Ripple (p-p): 10% max.	
Current consumption	140 mA max. with power supply voltage of 24 VDC (with Sensor connected)	
Ambient temperature	Operating and storage: 0 to 50°C (with no icing or condensation)	
Ambient humidity	Operating and storage: 35% to 85% (with no condensation)	
Insulation resistance	20 MΩ min. (at 500 DC)	
Dielectric strength	1,000 VAC, 50/60 Hz for 1 min	
Vibration resistance (destruction)	10 to 150 Hz with 0.7-mm double amplitude for 80 min each in X, Y, and Z directions	
Shock resistance (destruction)	300 m/s ² , 3 times each in 6 directions (up, down, left, right, forward, backward)	
Connection method	Prewired (standard cable length: 2 m)	
Weight (packed state)	Approx. 350 g	
Materials	Case: PBT (polybutylene terephthalate), Cover: Polycarbonate	
Accessories	Instruction Manual	

*1. The response speed of the linear output is calculated as the measurement period × (average count setting + 1).

The response speed of the judgement outputs is calculated as the measurement period × (average count setting + 1).

*2. The output can be switched between a current output and voltage output using a switch on the bottom of the Amplifier Unit.

*3. A Calculating Unit (ZX-CAL2) is required. Setting is possible via the monitor focus function.

*4. A Calculating Unit (ZX-CAL2) is required.

Note: For operating details, refer to the operation manual (Cat. No. Z166).

Dimensions

Sensors

Sensor Heads

ZX-EDR5T

Dimensions with Mounting Bracket Attached

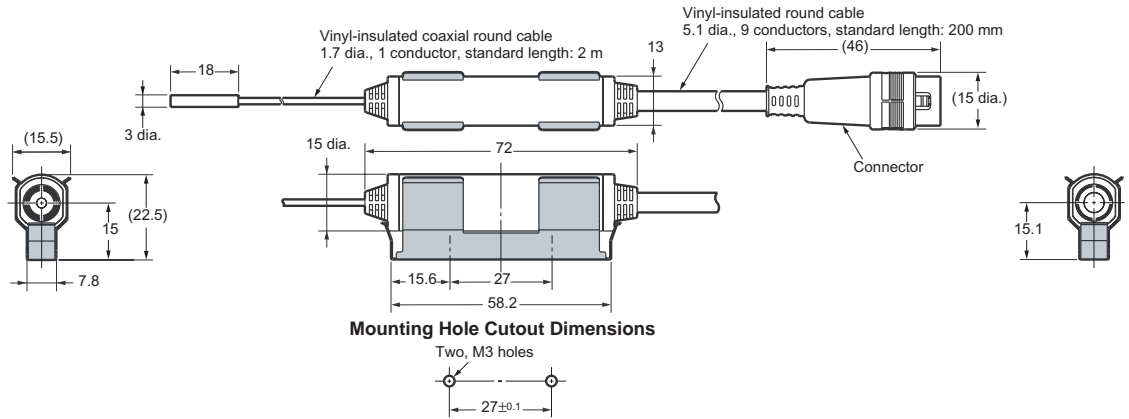

ZX-ED01T

Dimensions with Mounting Bracket Attached

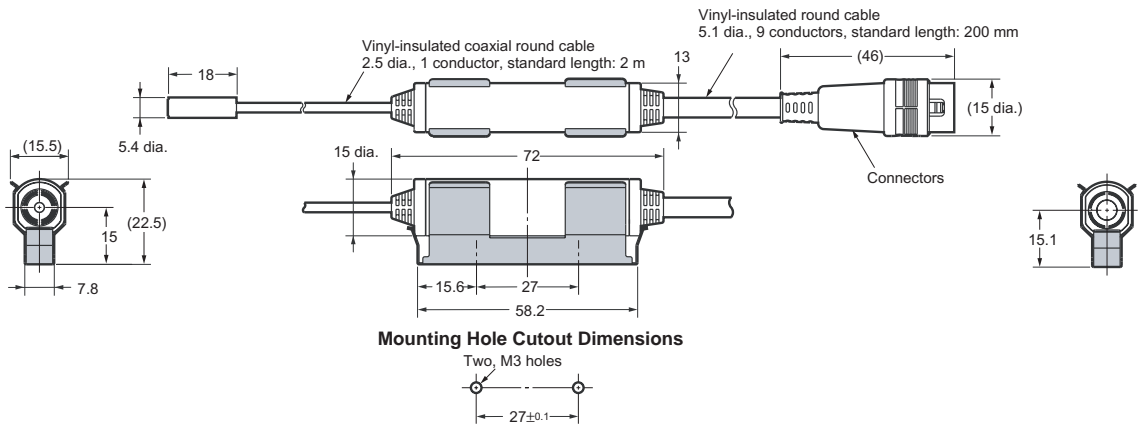

ZX-ED02T

Dimensions with Mounting Bracket Attached

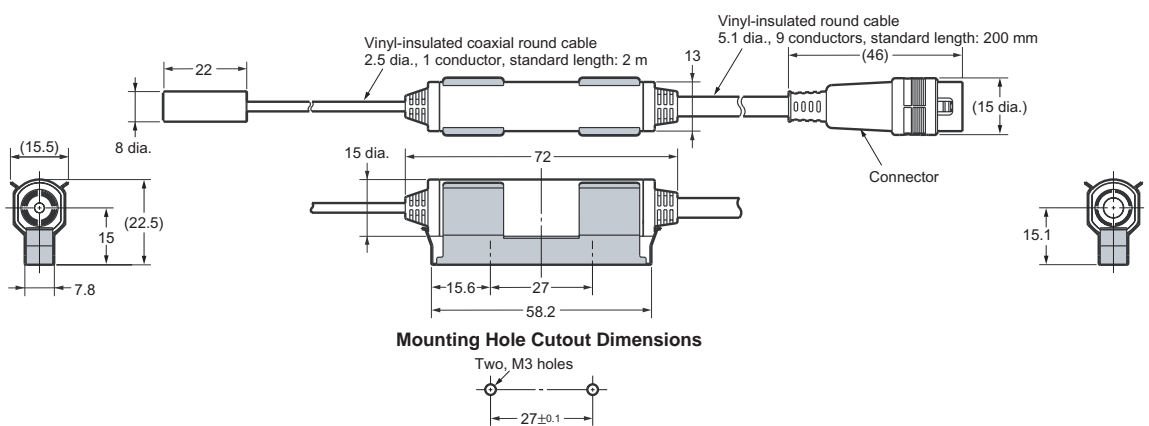

ZX-EM02T

Dimensions with Mounting Bracket Attached

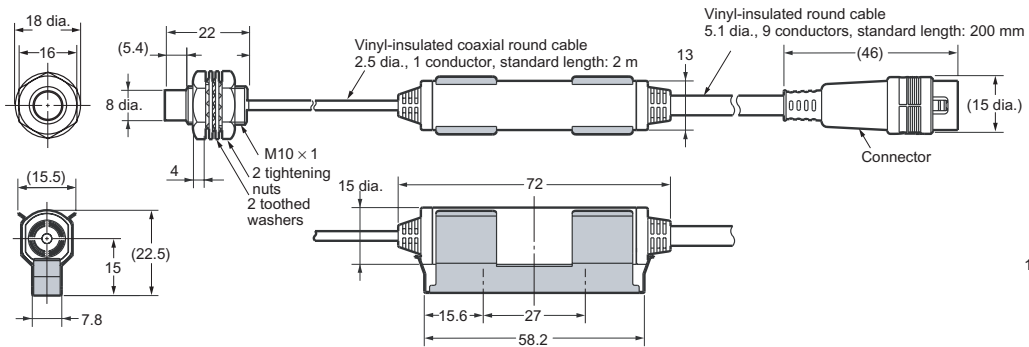

Mounting Hole Cutout Dimensions

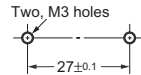

ZX-EM07MT

Dimensions with Mounting Bracket Attached

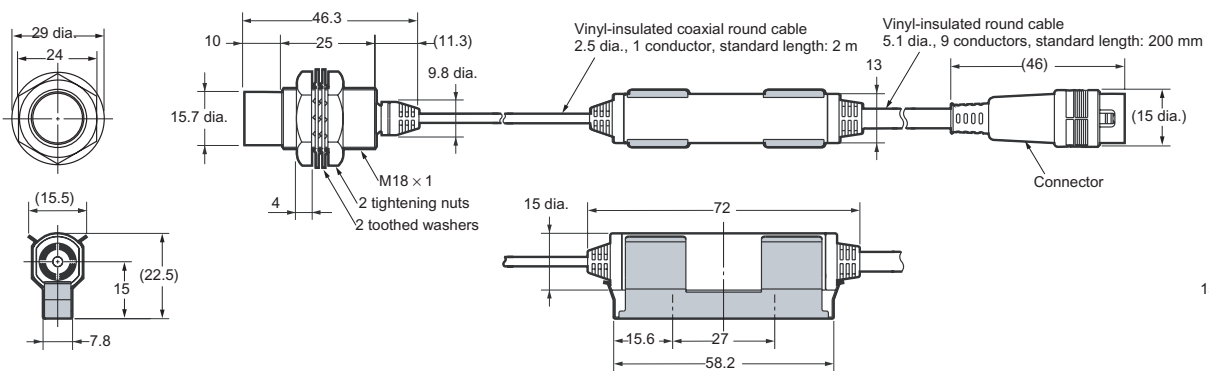

Mounting Hole Cutout Dimensions

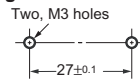

ZX-EV04T

Dimensions with Mounting Bracket Attached

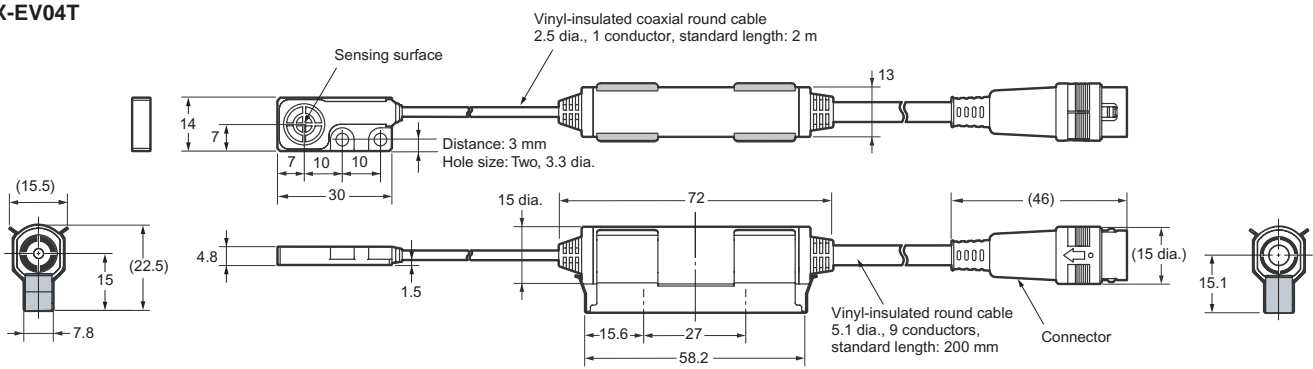

Mounting Hole Cutout Dimensions

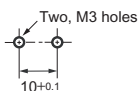

Mounting Hole Cutout Dimensions

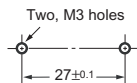

ZX-EM02HT

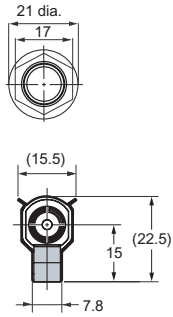

Dimensions with Mounting Bracket Attached

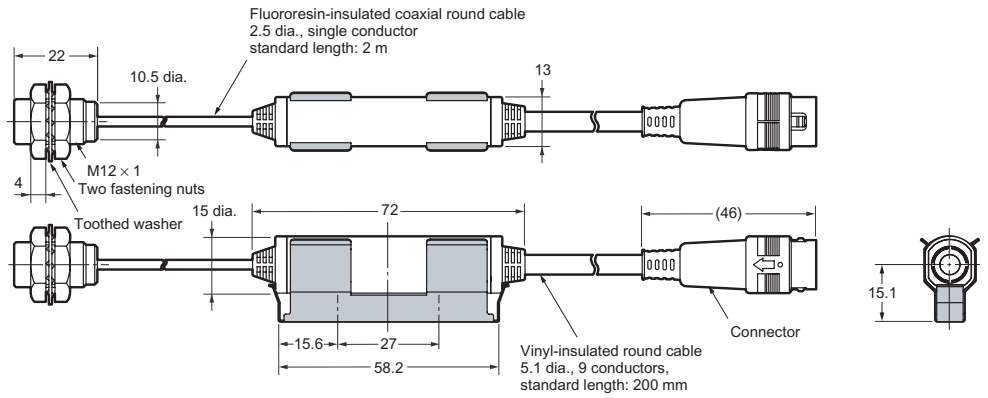

Mounting Hole Cutout Dimensions

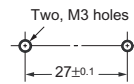

Amplifier Units

ZX-EDA11
ZX-EDA41

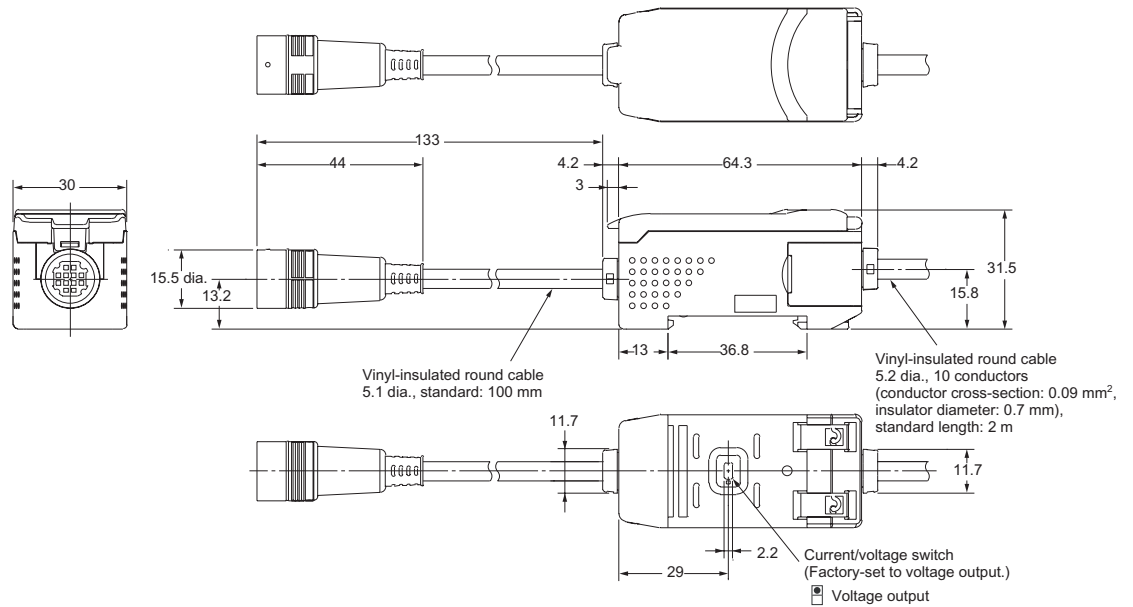

Accessories (Sold Separately)

Preamplifier Mounting Brackets

ZX-XBE1

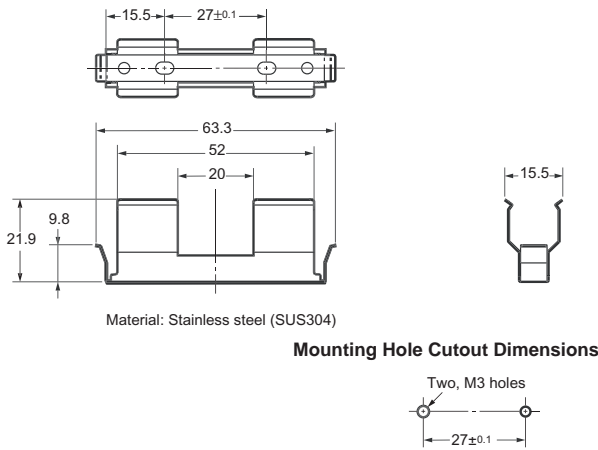

ZX-XBE2

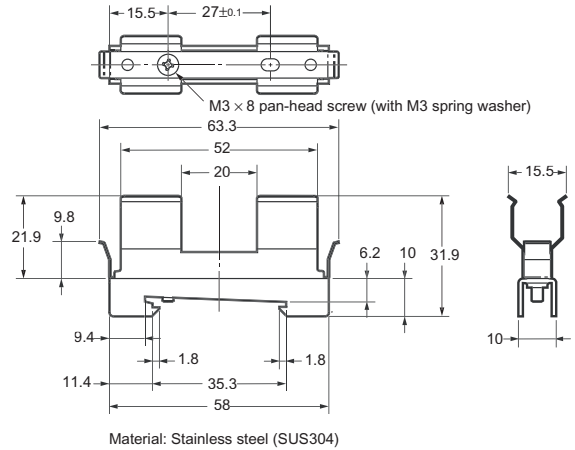

ZX-CAL2 Calculating Unit

Refer to page 17 for details.

ZX-SF11 ZX-series Communications Interface Unit

Refer to page 17 for details.

ZX-XC1A (1 m), ZX-XC4A (4 m), ZX-XC8A (8 m) Cables with Connectors on Both Ends (for Extension)

Refer to page 17 for details.

ZX-TDA High-precision Contact Sensors

Small & High Accuracy *for Smart Start*

Highest Level of Detection Performance in the Industry

Thinnest Level of Sensor Head in the Industry

With some of the thinnest Sensor Heads in the industry at just 6 mm in diameter, these Sensors are ideal for use in confined spaces and for multiple-point measurements.

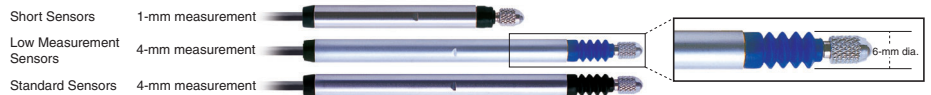

Highest Level of Resolution in the Industry

The long-stroke ZX-TDS04□ (4-mm measurement distance) achieves precise measurements with a maximum linearity of 0.3% FS and a resolution of 0.1 μm that ranks in the top class in the industry.

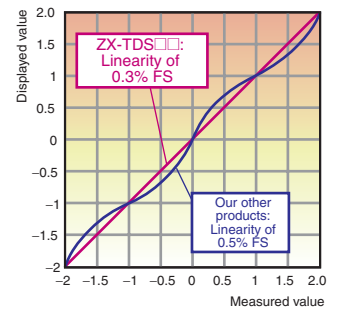

Complete Compatibility between Sensor Heads and Amplifier Units

The Amplifier Unit can be used as is when replacing damaged Sensor Heads or changing the Sensor Head for a different measurement distance.

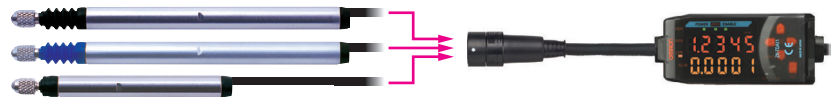

Built for Longer Life

The unique linear ball bearing structure ensures longer life. It has sliding parts that move smoothly and a rubber boot that keeps dust out. Short and Standard Sensors feature IP67 environmental resistance.

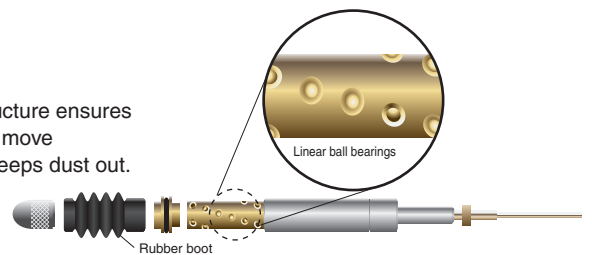

Multiple-point Computing Function

Connect up to 8 Sensor Heads.

Data obtained from one Sensor can be added and subtracted from the data for up to 7 other Sensors.

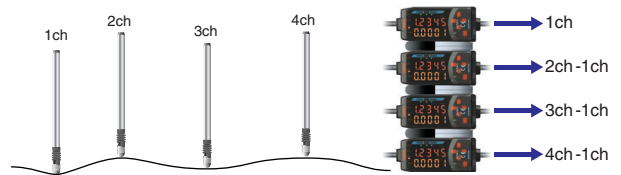

Early Warning Detection Function

In non-measurement situations, this function detects whether the Sensor is in danger of being damaged by overpressing and outputs an alarm signal. A sequence can be added with devices such as PLCs to provide measures to avoid damage, such as stopping measurements when this occurs.

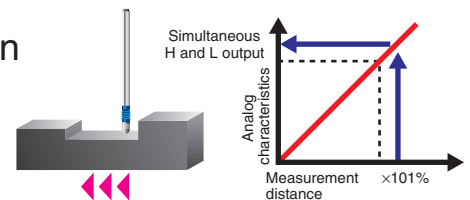

Warm-up Display

After the power is turned ON, the warm-up display indicates when the Sensor is ready to start measuring at optimum conditions (i.e. at the specified resolution).



Auto-scaling Function

The measurement distance can be displayed on the Amplifier simply by connecting the Sensor Head. The distance between the Amplifier Units and Sensor Heads can be extended to 3 m, 6 m, or 10 m using a ZX-XC□A Cable (sold separately).

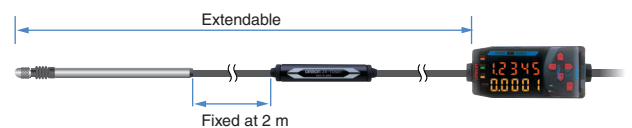

Origin Alignment No Longer Required

The differential transformer system eliminates the need for master adjustment and origin alignment every time the system is started. It also eliminates the time-consuming step of returning to the origin when power is interrupted.

ZX-TDA



Ordering Information

■ Sensors

Sensor Heads

Size	Type	Sensing distance	Resolution (See note.)	Model
6 dia.	Short type	1 mm	0.1 μm	ZX-TDS01T
6 dia.	Standard type	4 mm	0.1 μm	ZX-TDS04T
6 dia.	Low measurement type	4 mm	0.1 μm	ZX-TDS04T-L



Note: The resolution refers to the minimum value that can be read when a ZX-TDA□1 Amplifier Unit is connected.

■ Amplifier Units

Appearance	Power supply	Output type	Model
	DC	NPN	ZX-TDA11
		PNP	ZX-TDA41

■ Accessories (Order Separately)

Preamplifier Mounting Brackets

Appearance	Model	Remarks
	ZX-XBT1	Attached to each Sensor Head
	ZX-XBT2	For DIN track mounting

ZX-CAL2 Calculating Unit

Refer to pages 12 and 14 for details.

ZX-SF11 ZX-series Communications Interface Unit

Refer to pages 12 and 14 for details.

ZX-XC□A Cable with Connectors on Both Ends (for Extension)

Refer to page 12 for details.

ZX-SW11V3 Smart Monitor Sensor Setup Tool for Personal Computer Connection

Refer to page 12 for details.

Specifications

■ Sensor Heads

Item	ZX-TDS01T	ZX-TDS04T	ZX-TDS04T-L
Measurement range	1 mm	4 mm	
Maximum actuator travel distance	Approx. 1.5 mm	Approx. 5 mm	
Resolution *1	0.1 μm		
Linearity *2	0.3% F.S.		
Operating force *3	Approx. 0.7 N		Approx. 0.25 N
Degree of protection (Sensor Head)	IEC60529, IP67		IEC60529, IP54
Mechanical durability	10,000,000 operations min.		
Ambient temperature	Operating: 0°C to 50°C (with no icing or condensation) Storage: -15°C to 60°C (with no icing or condensation)		
Ambient humidity	Operating and storage: 35% to 85% (with no icing or condensation)		
Temperature characteristic *4	Sensor Head	0.03% F.S./°C	
	Preamplifier	0.01% F.S./°C	
Vibration resistance (destruction)	10 to 55 Hz with 0.35-mm single amplitude in the X, Y, and Z directions		
Shock resistance (destruction)	150 m/s ² , 3 times each in the X, Y, and Z directions		
Connection method	Connector relay (standard cable length: 2 m)		
Isolation	Isolated (Sensor Head enclosure and I/O lines)		
Weight (packed state)	Approx. 100 g		
Materials	Sensor Head	Stainless steel	
	Rubber boot	Fluorocarbon rubber	Silicon rubber
	Preamplifier	Polycarbonate	
Accessories	Instruction manual, Preamplifier Mounting Brackets (ZX-XBT1)		

*1. The resolution is given as the minimum value that can be read when a ZX-TDA□1 Amplifier Unit is connected. This value is taken 15 minutes after turning ON the power with the average number of operations set to 256.

*2. The linearity is given as the error in an ideal straight line displacement output.

*3. These figures are representative values that apply for the measurement mid-point, and are for when the provided actuator is used, with the actuator moving downwards. If the actuator moves horizontally or upwards, the operating force will be reduced. Also, if an actuator other than the standard one is used, the operating force will vary with the weight of the actuator itself.

*4. These figures are representative values that apply for the mid-point of the measurement range.







Amplifier Units

Item	ZX-TDA11	ZX-TDA41
Measurement period	1 ms	
Possible average count settings *1	1, 2, 4, 8, 16, 32, 64, 128, 256, 512, or 1,024	
Linear output *2	Current output: 4 to 20 mA/F.S., Max. load resistance: 300 Ω Voltage output: ±4 V (±5 V, 1 to 5 V), Output impedance: 100 Ω	
Judgement outputs (3 outputs: HIGH/PASS/LOW)	NPN open-collector outputs, 30 VDC, 30 mA max. Residual voltage: 1.2 V max.	PNP open-collector outputs, 30 VDC, 30 mA max. Residual voltage: 2 V max.
Zero reset input, timing input, reset input, judgement output hold input	ON: Short-circuited with 0-V terminal or 1.5 V or less OFF: Open (leakage current: 0.1 mA max.)	ON: Supply voltage short-circuited or supply voltage of 1.5 V or less OFF: Open (leakage current: 0.1 mA max.)
Function	<ul style="list-style-type: none"> - Measurement value display - Display reverse - Sample hold - Self-peak hold - Initial reset - Hysteresis width setting - Judgement output hold input - (A+B) calculations *4 - Zero reset memory - Clamp value setting - Span adjustment 	
Indicators	<ul style="list-style-type: none"> - Present value/set value/output value display - ECO mode - Peak hold - Self-bottom hold - Direct threshold value setting - Timing inputs - Monitor focus - Sensor disconnection detection - Function lock - Scale inversion - Warning-up display - Number of display digit changes - Bottom hold, peak-to-peak hold - Zero reset - Position teaching - Reset input - (A-B) calculations *4 - Non-measurement setting - Zero reset indicator - Pressing force alarm 	
Power supply voltage	12 to 24 VDC ±10%, Ripple (p-p): 10% max.	
Current consumption	140 mA max. (with Sensor connected), For 24-VDC power supply: 140 mA max. (with Sensor connected)	
Ambient temperature	Operating and storage: 0 to 50°C (with no icing or condensation)	
Ambient humidity	Operating and storage: 35% to 85% (with no icing or condensation)	
Temperature characteristic	0.03% F.S./°C	
Insulation resistance	20 MΩ min. at 500 VDC	
Dielectric strength	1,000 VAC, 50/60 Hz for 1 min	
Vibration resistance (destruction)	10 to 150 Hz with 0.7-mm double amplitude for 80 min each in X, Y, and Z directions	
Shock resistance (destruction)	300 m/s ² , 3 times each in six directions (up, down, left, right, forward, backward)	
Connection method	Prewired (standard cable length: 2 m)	
Weight (packed state)	Approx. 350 g	
Materials	Case: PBT (polybutylene terephthalate), Cover: Polycarbonate	
Accessories	Instruction sheet	

- *1. The response speed of the linear output is calculated as the measurement period × (average count setting + 1).
The response speed of the judgement outputs is calculated as the measurement period × (average count setting + 1).
- *2. The output can be switched between a current output and voltage output using a switch on the bottom of the Amplifier Unit.
- *3. Setting is possible via the monitor focus function.
- *4. A Calculating Unit (ZX-CAL2) is required.

Note: For operating details, refer to the operation manual (Cat. No. E346) provided by OMRON.

Options (Actuators)

Model	Type (material)	Screw section	Appearance	Application	Applicable Sensor *	
					ZX-TDS □ T	
D5SN-	TB1	Ball type (steel)	Female screw M2.5 x 0.45		Measuring ordinary flat surfaces (standard actuator supplied with the ZX-TDS Series)	○
	TB2	Ball type (carbide steel)	Female screw M2.5 x 0.45		Measurements where abrasion resistance is critical Measured objects: Carbide (HR90) or lower.	○
	TB3	Ball type (ruby)	Female screw M2.5 x 0.45		Measurements where abrasion resistance is critical Measured objects: Carbide (HR90) or higher.	○
	TN1	Needle type (carbide steel)	Male screw M2.5 x 0.45		Measuring the bottom of grooves and holes	△
	TF1	Flat (carbide steel)	Male screw M2.5 x 0.45		Measuring spherical objects	△
	TA	Conversion Adapter (stainless steel)	Through-hole female screw M2.5 x 0.45		Mounting D5SN-TN1/TF1 or commercially available actuators on ZX-TDS-series Sensors	○

Note: For optional Actuator combinations, the circle means the Actuator is replaceable and the triangle means that a Conversion Adapter is required.

Dimensions

D5SN-TB1/TB2/TB3

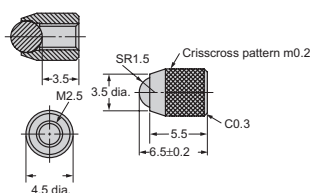

D5SN-TN1

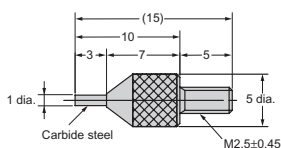

D5SN-TF1

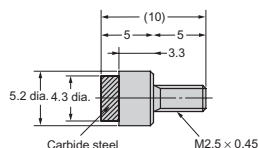

D5SN-TA

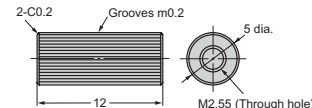

Dimensions

Sensors

ZX-TDS01T

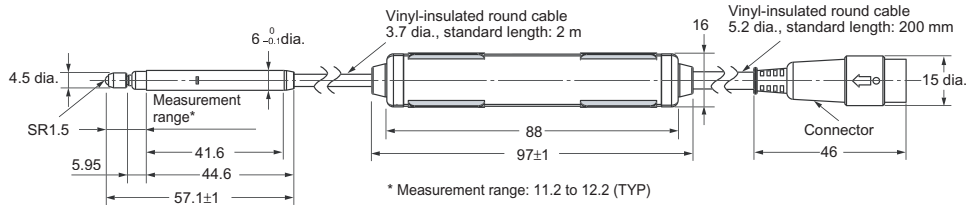

Mounting Hole Cutout Dimensions

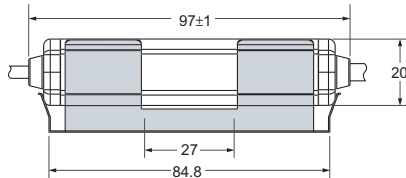
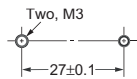

ZX-TDS04T ZX-TDS04T-L

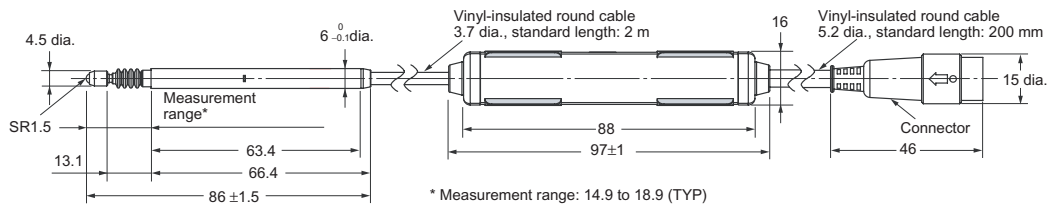

Mounting Hole Cutout Dimensions

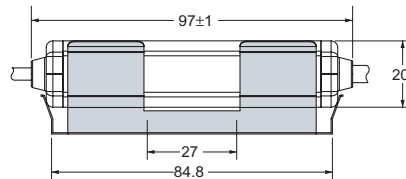
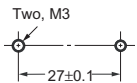

Amplifier Units

ZX-TDA11 ZX-TDA41

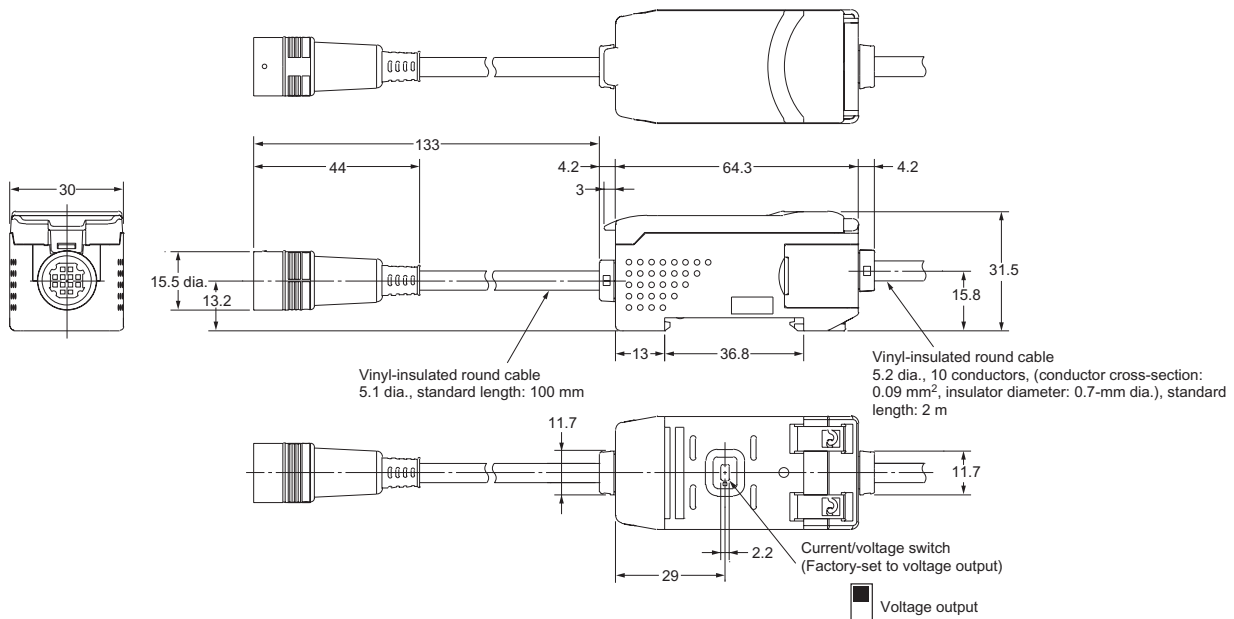

■ Accessories (Order Separately)

Preamplifier Mounting Bracket (Supplied with Each Sensor)

ZX-XBT1

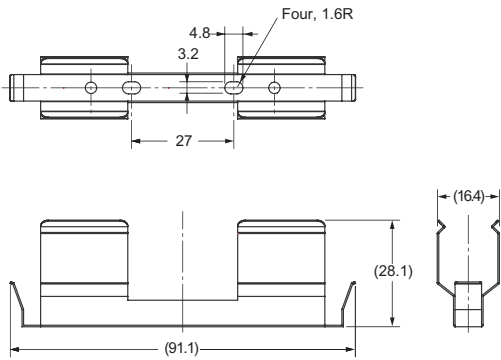

Material: Stainless steel

Mounting Hole Cutout Dimensions

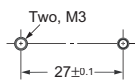

ZX-XBT2 (For DIN Track Mounting)

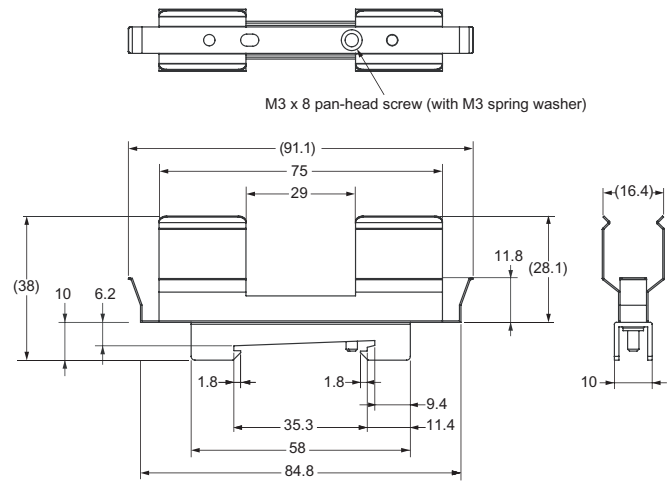

Material: Stainless steel

ZXCAL2 Calculating Unit

Refer to page 17 for details.

ZX-SF11 ZX-series Communications Interface Unit

Refer to page 17 for details.

ZX-XC1A (1 m), ZX-XC4A (4 m), ZX-XC8A (8 m) Cables with Connectors on Both Ends (for Extension)

Refer to page 17 for details.

Precautions

■ Design Precautions

Conform to the specified ratings and performance. Refer to the *Specifications* for each product on the following pages.

ZX-L: Pages 13 and 14

ZX-E: Pages 21 and 22

ZX-T: Pages 31 and 32

Environment

Do not operate the product in locations subject to flammable or explosive gases.

In order to ensure safe operation and maintenance, do not install the product in the vicinity of high-voltage devices or power equipment.

■ Correct Use

This product consists of precision parts that may fail if it is dropped.

Design Precautions

Compatibility

Sensors and Amplifier Units are mutually compatible. Sensors can be added or replaced individually.

Influence of High-frequency Electromagnetic Fields

Using the product in the vicinity of devices that generate high-frequency electromagnetic fields, such as ultrasonic cleaning equipment, high-frequency generators, transceivers, mobile phones, and inverters, may result in malfunction.

Wiring

Wiring Check

After wiring is completed, before turning ON the power, confirm that the power supply is connected correctly, that there are no faulty connections, such as load short-circuits, and that the load current is correct. Incorrect wiring may result in failure.

Cable Extension

Do not extend the cable for the Sensor and the Amplifier Unit to a length exceeding 10 m. Use a ZX-XC□A Extension Cable (sold separately) to extend the Sensor's cable. Extend the Amplifier Unit's cable using a shielded cable of the same type.

Wiring

Do not use the product at voltages exceeding the rated values. Doing so may result in damage.

Do not connect the product to an AC power supply or connect the power supply in reverse.

Do not short loads connected to open-collector outputs.

Do not lay the cable for the product together with or in the same duct as high-voltage lines or power lines. Doing so may result in incorrect operation or damage due to induction.

Other Precautions

Do not attempt to disassemble, repair, or modify the product.

Dispose of the product using standard procedures for industrial waste.

Do not connect combinations of ZX-L□□-, ZX-E□□-, and ZX-T□□- series Smart Sensors.

Power Supply

When using a commercially available switching regulator, ground the FG (frame ground) terminal.

If the power supply line is subject to surges, connect a surge absorber that meets the conditions of the operating environment.

Calculating Unit

When using a Calculating Unit, connect the linear output ground of the corresponding Amplifier Unit.

Connectors

Do not connect or disconnect connectors while the power is ON.

Be sure hold to connectors by the cover when connecting or disconnecting.

Installation Location

Do not install the product in the following locations.

- Locations subject to temperatures outside the specified range
- Locations subject to condensation due to sudden temperature changes
- Locations subject to humidity levels outside range 35% to 85%
- Locations subject to corrosive or flammable gases
- Locations subject to dust, salts, or metallic powder.
- Locations directly subject to vibrations and shocks
- Locations subject to splashes of water, oil, or chemicals
- Locations subject to strong electromagnetic or electrical fields

Maintenance and Inspection

- Be sure to turn OFF the power supply before adjusting or removing the Sensor Head.
- Cleaning:
 - Do not use thinners, benzene, acetone, or kerosene for cleaning.

Terms and Conditions of Sale

1. **Offer; Acceptance.** These terms and conditions (these "Terms") are deemed part of all quotes, agreements, purchase orders, acknowledgments, price lists, catalogs, manuals, brochures and other documents, whether electronic or in writing, relating to the sale of products or services (collectively, the "Products") by Omron Electronics LLC and its subsidiary companies ("Omron"). Omron objects to any terms or conditions proposed in Buyer's purchase order or other documents which are inconsistent with, or in addition to, these Terms.
2. **Prices; Payment Terms.** All prices stated are current, subject to change without notice by Omron. Omron reserves the right to increase or decrease prices on any unshipped portions of outstanding orders. Payments for Products are due net 30 days unless otherwise stated in the invoice.
3. **Discounts.** Cash discounts, if any, will apply only on the net amount of invoices sent to Buyer after deducting transportation charges, taxes and duties, and will be allowed only if (i) the invoice is paid according to Omron's payment terms and (ii) Buyer has no past due amounts.
4. **Interest.** Omron, at its option, may charge Buyer 1-1/2% interest per month or the maximum legal rate, whichever is less, on any balance not paid within the stated terms.
5. **Orders.** Omron will accept no order less than \$200 net billing.
6. **Governmental Approvals.** Buyer shall be responsible for, and shall bear all costs involved in, obtaining any government approvals required for the importation or sale of the Products.
7. **Taxes.** All taxes, duties and other governmental charges (other than general real property and income taxes), including any interest or penalties thereon, imposed directly or indirectly on Omron or required to be collected directly or indirectly by Omron for the manufacture, production, sale, delivery, importation, consumption or use of the Products sold hereunder (including customs duties and sales, excise, use, turnover and license taxes) shall be charged to and remitted by Buyer to Omron.
8. **Financial.** If the financial position of Buyer at any time becomes unsatisfactory to Omron, Omron reserves the right to stop shipments or require satisfactory security or payment in advance. If Buyer fails to make payment or otherwise comply with these Terms or any related agreement, Omron may (without liability and in addition to other remedies) cancel any unshipped portion of Products sold hereunder and stop any Products in transit until Buyer pays all amounts, including amounts payable hereunder, whether or not then due, which are owing to it by Buyer. Buyer shall in any event remain liable for all unpaid accounts.
9. **Cancellation; Etc.** Orders are not subject to rescheduling or cancellation unless Buyer indemnifies Omron against all related costs or expenses.
10. **Force Majeure.** Omron shall not be liable for any delay or failure in delivery resulting from causes beyond its control, including earthquakes, fires, floods, strikes or other labor disputes, shortage of labor or materials, accidents to machinery, acts of sabotage, riots, delay in or lack of transportation or the requirements of any government authority.
11. **Shipping; Delivery.** Unless otherwise expressly agreed in writing by Omron:
 - a. Shipments shall be by a carrier selected by Omron; Omron will not drop ship except in "break down" situations.
 - b. Such carrier shall act as the agent of Buyer and delivery to such carrier shall constitute delivery to Buyer;
 - c. All sales and shipments of Products shall be FOB shipping point (unless otherwise stated in writing by Omron), at which point title and risk of loss shall pass from Omron to Buyer; provided that Omron shall retain a security interest in the Products until the full purchase price is paid;
 - d. Delivery and shipping dates are estimates only; and
 - e. Omron will package Products as it deems proper for protection against normal handling and extra charges apply to special conditions.
12. **Claims.** Any claim by Buyer against Omron for shortage or damage to the Products occurring before delivery to the carrier must be presented in writing to Omron within 30 days of receipt of shipment and include the original transportation bill signed by the carrier noting that the carrier received the Products from Omron in the condition claimed.
13. **Warranties.** (a) **Exclusive Warranty.** Omron's exclusive warranty is that the Products will be free from defects in materials and workmanship for a period of twelve months from the date of sale by Omron (or such other period expressed in writing by Omron). Omron disclaims all other warranties, express or implied. (b) **Limitations.** OMRON MAKES NO WARRANTY OR REPRESENTATION, EXPRESS OR IMPLIED, ABOUT NON-INFRINGEMENT, MERCHANTABILITY OR FITNESS FOR A PARTICULAR PURPOSE OF THE PRODUCTS. BUYER ACKNOWLEDGES THAT IT ALONE HAS DETERMINED THAT THE PRODUCTS WILL SUITABLY MEET THE REQUIREMENTS OF THEIR INTENDED USE. Omron further disclaims all warranties and responsibility of any type for claims or expenses based on infringement by the Products or otherwise of any intellectual property right. (c) **Buyer Remedy.** Omron's sole obligation hereunder shall be, at Omron's election, to (i) replace (in the form originally shipped with Buyer responsible for labor charges for removal or replacement thereof) the non-complying Product, (ii) repair the non-complying Product, or (iii) repay or credit Buyer an amount equal to the purchase price of the non-complying Product; provided that in no event shall Omron be responsible for warranty, repair, indemnity or any other claims or expenses regarding the Products unless Omron's analysis confirms that the Products were properly handled, stored, installed and maintained and not subject to contamination, abuse, misuse or inappropriate modification. Return of any Products by Buyer must be approved in writing by Omron before shipment. Omron Companies shall not be liable for the suitability or unsuitability or the results from the use of Products in combination with any electrical or electronic components, circuits, system assemblies or any other materials or substances or environments. Any advice, recommendations or information given orally or in writing, are not to be construed as an amendment or addition to the above warranty. See <http://oeweb.omron.com> or contact your Omron representative for published information.
14. **Limitation on Liability; Etc.** OMRON COMPANIES SHALL NOT BE LIABLE FOR SPECIAL, INDIRECT, INCIDENTAL, OR CONSEQUENTIAL DAMAGES, LOSS OF PROFITS OR PRODUCTION OR COMMERCIAL LOSS IN ANY WAY CONNECTED WITH THE PRODUCTS, WHETHER SUCH CLAIM IS BASED IN CONTRACT, WARRANTY, NEGLIGENCE OR STRICT LIABILITY. Further, in no event shall liability of Omron Companies exceed the individual price of the Product on which liability is asserted.
15. **Indemnities.** Buyer shall indemnify and hold harmless Omron Companies and their employees from and against all liabilities, losses, claims, costs and expenses (including attorney's fees and expenses) related to any claim, investigation, litigation or proceeding (whether or not Omron is a party) which arises or is alleged to arise from Buyer's acts or omissions under these Terms or in any way with respect to the Products. Without limiting the foregoing, Buyer (at its own expense) shall indemnify and hold harmless Omron and defend or settle any action brought against such Companies to the extent based on a claim that any Product made to Buyer specifications infringed intellectual property rights of another party.
16. **Property; Confidentiality.** Any intellectual property in the Products is the exclusive property of Omron Companies and Buyer shall not attempt to duplicate it in any way without the written permission of Omron. Notwithstanding any charges to Buyer for engineering or tooling, all engineering and tooling shall remain the exclusive property of Omron. All information and materials supplied by Omron to Buyer relating to the Products are confidential and proprietary, and Buyer shall limit distribution thereof to its trusted employees and strictly prevent disclosure to any third party.
17. **Export Controls.** Buyer shall comply with all applicable laws, regulations and licenses regarding (i) export of products or information; (ii) sale of products to "forbidden" or other proscribed persons; and (iii) disclosure to non-citizens of regulated technology or information.
18. **Miscellaneous.** (a) **Waiver.** No failure or delay by Omron in exercising any right and no course of dealing between Buyer and Omron shall operate as a waiver of rights by Omron. (b) **Assignment.** Buyer may not assign its rights hereunder without Omron's written consent. (c) **Law.** These Terms are governed by the law of the jurisdiction of the home office of the Omron company from which Buyer is purchasing the Products (without regard to conflict of law principles). (d) **Amendment.** These Terms constitute the entire agreement between Buyer and Omron relating to the Products, and no provision may be changed or waived unless in writing signed by the parties. (e) **Severability.** If any provision hereof is rendered ineffective or invalid, such provision shall not invalidate any other provision. (f) **Setoff.** Buyer shall have no right to set off any amounts against the amount owing in respect of this invoice. (g) **Definitions.** As used herein, "including" means "including without limitation"; and "Omron Companies" (or similar words) mean Omron Corporation and any direct or indirect subsidiary or affiliate thereof.

Certain Precautions on Specifications and Use

1. **Suitability of Use.** Omron Companies shall not be responsible for conformity with any standards, codes or regulations which apply to the combination of the Product in the Buyer's application or use of the Product. At Buyer's request, Omron will provide applicable third party certification documents identifying ratings and limitations of use which apply to the Product. This information by itself is not sufficient for a complete determination of the suitability of the Product in combination with the end product, machine, system, or other application or use. Buyer shall be solely responsible for determining appropriateness of the particular Product with respect to Buyer's application, product or system. Buyer shall take application responsibility in all cases but the following is a non-exhaustive list of applications for which particular attention must be given:
 - (i) Outdoor use, uses involving potential chemical contamination or electrical interference, or conditions or uses not described in this document.
 - (ii) Use in consumer products or any use in significant quantities.
 - (iii) Energy control systems, combustion systems, railroad systems, aviation systems, medical equipment, amusement machines, vehicles, safety equipment, and installations subject to separate industry or government regulations.
 - (iv) Systems, machines and equipment that could present a risk to life or property. Please know and observe all prohibitions of use applicable to this Product.
 NEVER USE THE PRODUCT FOR AN APPLICATION INVOLVING SERIOUS RISK TO LIFE OR PROPERTY OR IN LARGE QUANTITIES WITHOUT ENSURING THAT THE SYSTEM AS A WHOLE HAS BEEN DESIGNED TO ADDRESS THE RISKS, AND THAT THE OMRON'S PRODUCT IS PROPERLY RATED AND INSTALLED FOR THE INTENDED USE WITHIN THE OVERALL EQUIPMENT OR SYSTEM.
2. **Programmable Products.** Omron Companies shall not be responsible for the user's programming of a programmable Product, or any consequence thereof.
3. **Performance Data.** Data presented in Omron Company websites, catalogs and other materials is provided as a guide for the user in determining suitability and does not constitute a warranty. It may represent the result of Omron's test conditions, and the user must correlate it to actual application requirements. Actual performance is subject to the Omron's Warranty and Limitations of Liability.
4. **Change in Specifications.** Product specifications and accessories may be changed at any time based on improvements and other reasons. It is our practice to change part numbers when published ratings or features are changed, or when significant construction changes are made. However, some specifications of the Product may be changed without any notice. When in doubt, special part numbers may be assigned to fix or establish key specifications for your application. Please consult with your Omron's representative at any time to confirm actual specifications of purchased Product.
5. **Errors and Omissions.** Information presented by Omron Companies has been checked and is believed to be accurate; however, no responsibility is assumed for clerical, typographical or proofreading errors or omissions.

Complete "Terms and Conditions of Sale" for product purchase and use are on Omron's website at www.omron.com/oei – under the "About Us" tab, in the Legal Matters section.

ALL DIMENSIONS SHOWN ARE IN MILLIMETERS.

To convert millimeters into inches, multiply by 0.03937. To convert grams into ounces, multiply by 0.03527.

OMRON[®]**OMRON ELECTRONICS LLC**

One Commerce Drive
Schaumburg, IL 60173

847-843-7900

For US technical support or other inquiries:

800-556-6766**OMRON CANADA, INC.**

885 Milner Avenue
Toronto, Ontario M1B 5V8

416-286-6465**OMRON ON-LINE**

Global - <http://www.omron.com>
USA - <http://www.omron.com/oei>
Canada - <http://www.omron.ca>