

Four-Way 0° Power Splitter Combiner 1.71–1.99 GHz



PD4W18-12

Features

- Low Cost
- Low Profile
- Available in Small SOIC-8 Package
- Tape & Reel

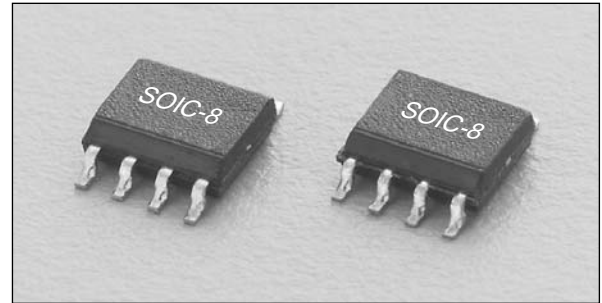

Description

The PD4W18-12 is a monolithic four-way in-phase hybrid junction tuned for the 1.71–1.99 GHz band. It offers low loss, high isolation, good input/output matching and exceptional phase/amplitude balance. It is available in the SOIC-8 leaded surface mount package.

Electrical Specifications at 25°C

Parameter	Min.	Typ.	Max.	Unit
Frequency	1.71		1.99	GHz
Insertion Loss Less 6 dB Split		0.7	1.0	dB
Isolation	18	25		dB
Input VSWR		1.6:1	1.8:1	
Output VSWR		1.2:1	1.5:1	
Amplitude Balance		±3	±4	dB
Phase Balance		±5.0	±9.0	Deg.

Pin Out

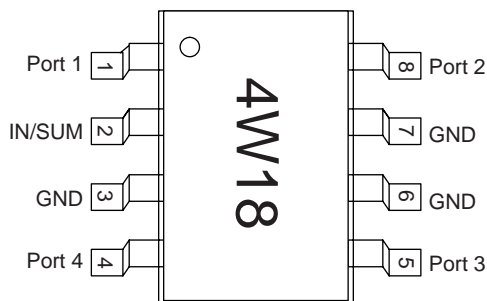

Block Diagram

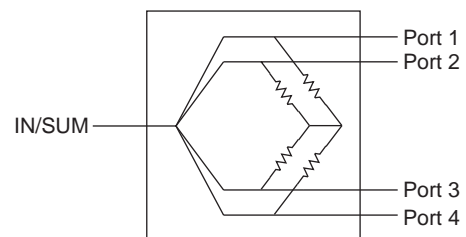

Typical Performance Data

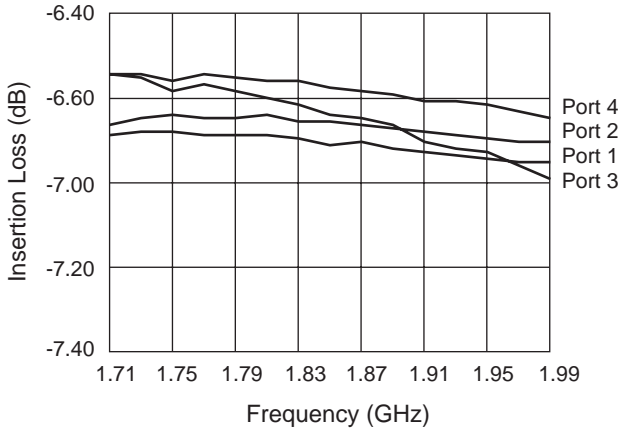

Insertion Loss vs. Frequency

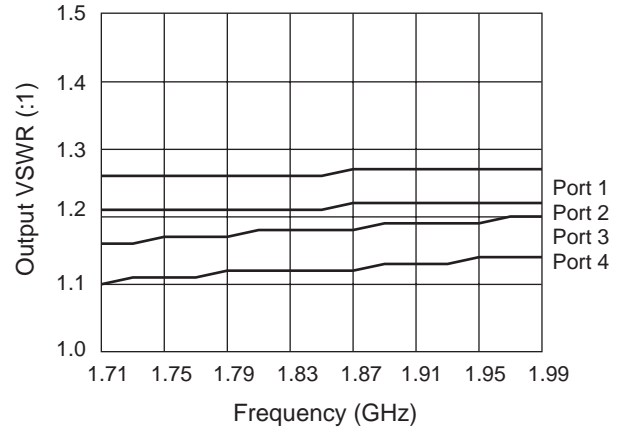

Output VSWR vs. Frequency

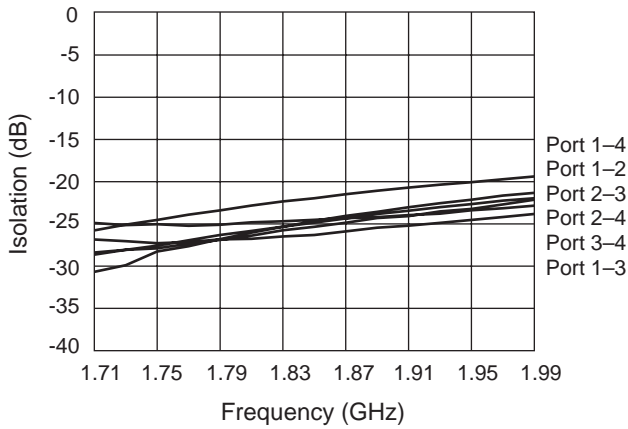

Isolation vs. Frequency

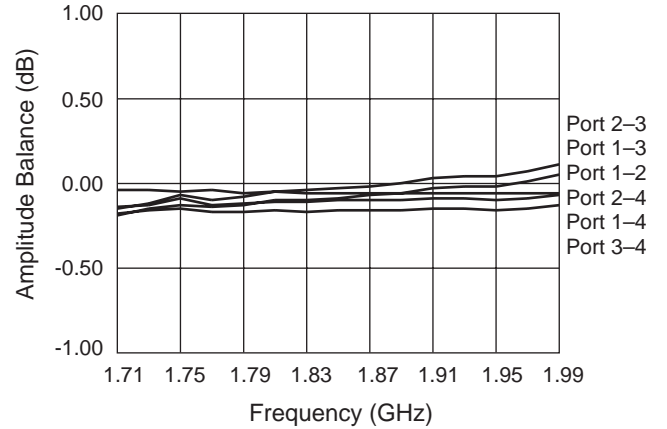

Amplitude Balance vs. Frequency

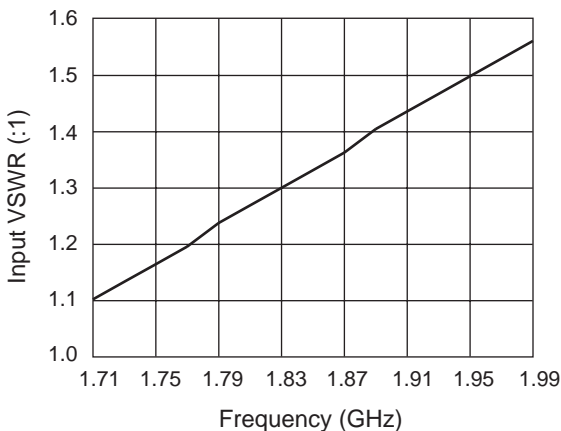

Input VSWR vs. Frequency

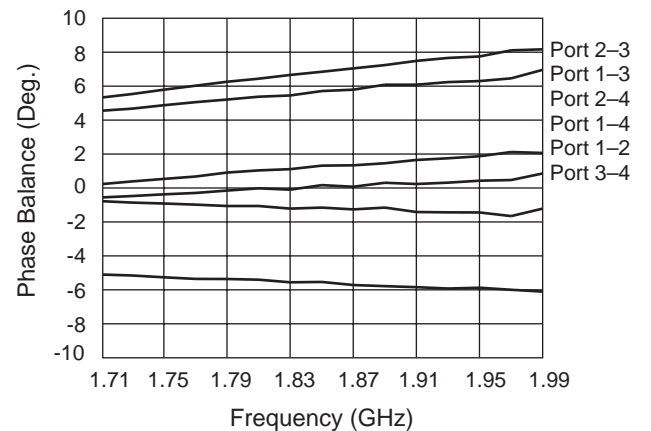

Phase Balance vs. Frequency

Absolute Maximum Ratings

Characteristic	Value
Input Power ¹	+1.5 W CW
Input Power ²	+0.375 CW
Operating Temperature	-40°C to +85°C
Storage Temperature	-60°C to +150°C

1. When used as a power divider with a 2.0:1 Max. VSWR on all ports.
2. When used as a power combiner with 2.0:1 Max. VSWR on all ports.

Board Layout

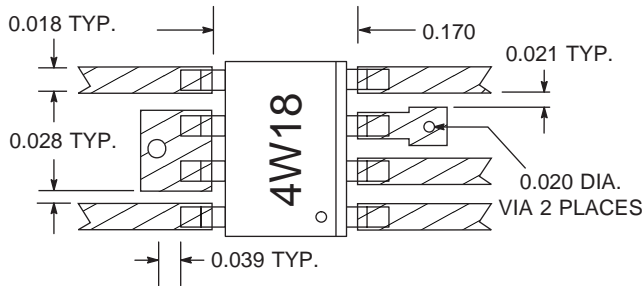

Material is 10 mil FR4

SOIC-8

