

# C&K E020 Series Sealed Snap-acting Momentary Pushbutton Switches

## Features/Benefits

- Process sealed with disposable splashproof boot
- Long life contact design
- Snap-fitting plunger available
- RoHS compliant models available

## Typical Applications

- Instrumentation
- Telecommunications and networking equipment
- Computers and peripherals



## Specifications

**CONTACT RATING:** B contact material (EX25 Models): 0.4 VA max. @ 20 V AC or DC max. G contact material (EX21 Models): 1 AMP @ 120 V AC or 28 V DC or 0.4 VA max. @ 20 V AC or DC max.  
**Note:** Break-before-make contacts. Multi-pole contacts do not make and break simultaneously. See page A-24 for additional ratings.

**ELECTRICAL LIFE:** 60,000 make-and-break cycles at full load.

**CONTACT RESISTANCE:** Below 50 mΩ typ. initial @ 2-4 V DC, 100 mA, for both silver and gold plated contacts.

**INSULATION RESISTANCE:** 10<sup>9</sup>Ω min.

**DIELECTRIC STRENGTH:** 1000 Vrms min. @ sea level.

**OPERATING TEMPERATURE:** -30°C to 75°C.

**CAP INSTALLATION FORCE:** 10 lbs. max. permissible.

**SOLDERABILITY:** Per MIL-STD-202F method 208D, or

EIA RS-186E method 9 (1 hour steam aging).

**NOTE:** Any models supplied with P, R, B or G contact material are RoHS compliant. For the latest information regarding RoHS compliance, please go to: [www.ittcannon.com/rohs](http://www.ittcannon.com/rohs).

**NOTE:** Specifications and materials listed above are for switches with standard options. For information on specific and custom switches consult Customer Service Center.

## Materials

**CASE & BUSHING:** Glass filled nylon 6/6, flame retardant (UL 94V-0).

**PLUNGER:** Glass filled nylon or glass filled polyester (PBT) (UL 94V-0).

**SWITCH SUPPORT:** Brass or steel, matte-tin.

**SWITCH SUPPORT RETAINER:** Stainless steel.

**N.O. & N.C. CONTACTS:** EX25 MODELS: B contact material: Copper alloy, with gold plate over nickel plate. EX21 MODELS: G contact material: Coin silver, with gold plate over nickel plate. See page A-28 for additional contact materials.

**COMMON CONTACTS & ALL TERMINALS:** Copper alloy, with gold plate over nickel plate. See page A-24 for additional contact materials.

**TERMINAL SEAL:** Epoxy.

**DISPOSABLE BOOT:** Vinyl splashproof boot supplied standard. Remove and discard only after soldering and cleaning processes are complete.

## Build-A-Switch

To order, simply select desired option from each category and place in the appropriate box. Available options are shown and described on pages A-20 thru A-26. For additional options not shown in catalog, consult our Customer Service Center. All models are process sealed to withstand machine soldering temperatures and pressure wash cleaning methods.

<p><b>Switch Function</b></p> <p><b>E121</b> SPDT On-Mom. 1 Amp  <b>E221</b> DPDT On-Mom. 1 Amp  <b>E125</b> SPDT On-Mom. 0.4VA  <b>E225</b> DPDT On-Mom. 0.4VA</p> <p><b>Plunger</b></p> <p><b>S</b> .282" high  <b>M</b> .331" high, snap-fitting  <b>S1</b> .332" high</p>	<p><b>Bushing</b></p> <p><b>D1</b> Unthreaded  <b>D3</b> .180" high, unthreaded</p> <p><b>Terminations</b></p> <p><b>A</b> Right angle, PC thru-hole  <b>AV2</b> Vertical right angle, PC thru-hole  <b>C</b> PC Thru-hole  <b>A3</b> Right angle, snap-in, PC thru-hole  <b>AV3</b> Vertical right angle, snap-in, PC thru-hole  <b>V3</b> .460" high, V-bracket  <b>V4</b> .630" high, V-bracket  <b>V6</b> .460" high, V-bracket  <b>V8</b> .953" high, V-bracket  <b>V31</b> .460" high, snap-in V-bracket  <b>V41</b> .630" high, snap-in V-bracket  <b>V61</b> .460" high, snap-in V-bracket</p>	<p><b>Contact Material</b></p> <p><b>B</b> Gold  <b>K</b> Gold, tin-lead  <b>G</b> Gold, matte-tin  <b>P</b> Gold over silver  <b>L</b> Gold over silver, tin-lead  <b>R</b> Gold over silver, matte-tin</p> <p><b>Seal</b></p> <p><b>E</b> Epoxy and disposable splashproof boot</p>
---	--	---



Dimensions are shown: Inches (mm)  
 Specifications and dimensions subject to change



# C&K E020 Series Sealed Snap-acting Momentary Pushbutton Switches

## SWITCH FUNCTION

Pushbutton

NO. POLES	MODEL NO.	SWITCH FUNCTION		CONNECTED TERMINALS		SCHEMATIC
		POS. 1	POS. 2	POS. 1	POS. 2	
SP	<b>E121</b>	ON	MOM.	1-3	1-2	
	<b>E125</b>	ON	MOM.			
<p><b>SPDT</b></p> <p>Part number shown: E121SD1CGE</p>						
DP	<b>E221</b>	ON	MOM.	1-3,4-6	1-2,4-5	
	<b>E225</b>	ON	MOM.			
<p><b>DPDT</b></p> <p>Part number shown: E221SD1CBE</p>						

MOM. = Momentary

E121, E221 models with all options when ordered with G, L or R contact material.

EX25 models must be ordered with B, K or P contact material.  
EX21 models must be ordered with G, L or R contact material.

## PLUNGER

**S** .282" HIGH

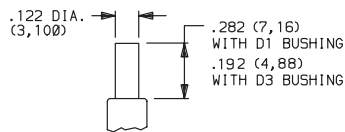

**S1** .332" HIGH

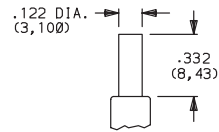

Not Available with D1 bushing.

**M** .332" HIGH SNAP-FITTING

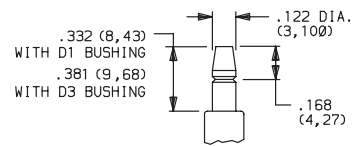

NOTE: Caps available for all plunger options, see page A-25.

## BUSHING

**D1** UNTHREADED

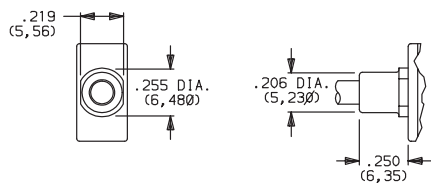

Not available with S1 actuator.

**D3** .180" HIGH UNTHREADED

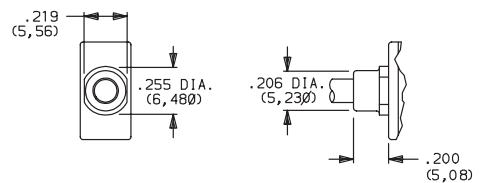

NOTE: Disposable splashproof vinyl over actuator and bushing supplied std., see page A-24.

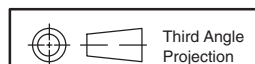

Dimensions are shown: Inches (mm)  
Specifications and dimensions subject to change



# C&K E020 Series Sealed Snap-acting Momentary Pushbutton Switches

## TERMINATIONS



### C PC THRU-HOLE

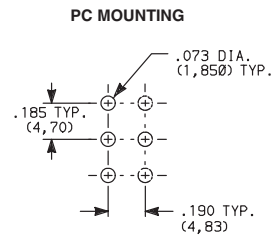
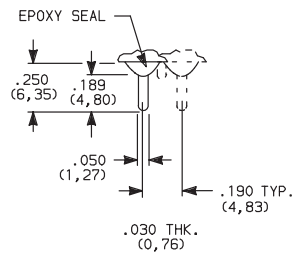

## SPDT and DPDT

### A RIGHT ANGLE, PC THRU-HOLE

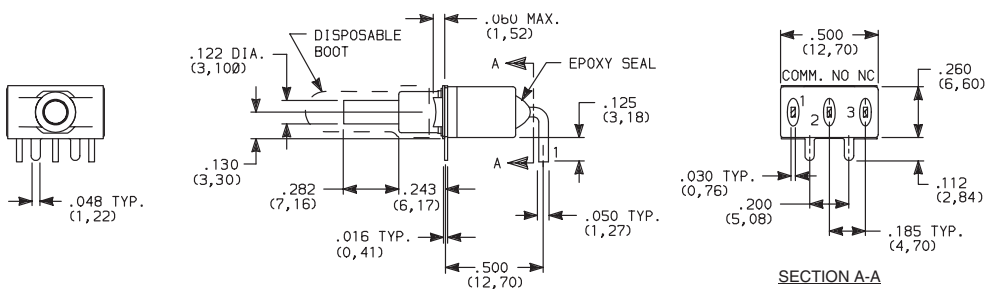

E121SD1AGE  
SPDT

### A3 RIGHT ANGLE, SNAP-IN, PC THRU-HOLE

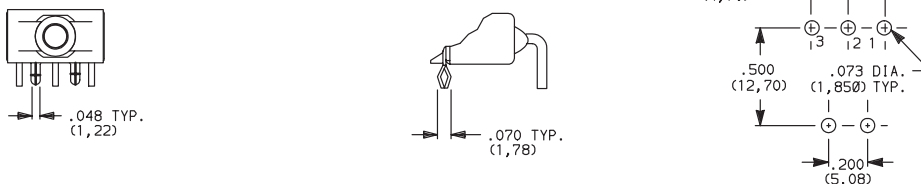

NOTE: Terminal bend radii and lead-in manufacturing option.

### A RIGHT ANGLE, PC THRU-HOLE

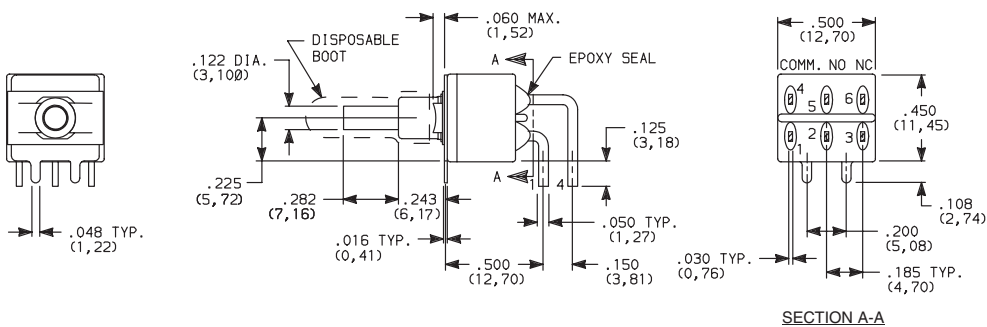

E221SD1AGE  
DPDT

### A3 RIGHT ANGLE, SNAP-IN, PC THRU-HOLE

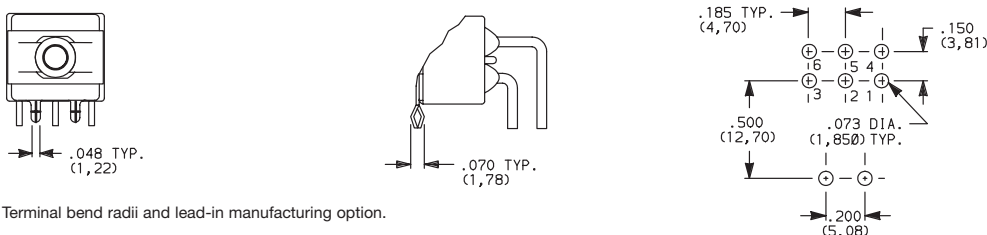

NOTE: Terminal bend radii and lead-in manufacturing option.

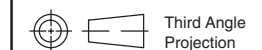

Dimensions are shown: Inches (mm)  
Specifications and dimensions subject to change



# C&K E020 Series Sealed Snap-acting Momentary Pushbutton Switches

## TERMINATIONS

A

Pushbutton

**AV2** VERTICAL RIGHT ANGLE, PC THRU-HOLE, .150" PITCH



**E121SD1AV2GE SPDT**

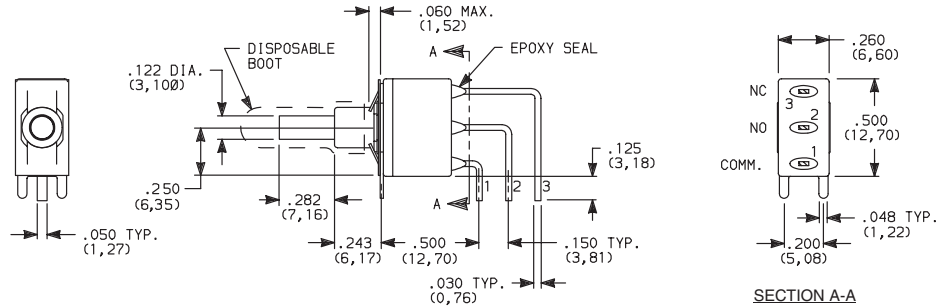

**AV3** VERTICAL RIGHT ANGLE, SNAP-IN, PC THRU-HOLE, .150" PITCH

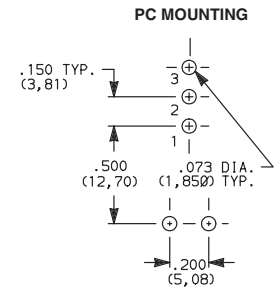
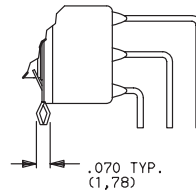
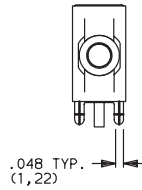

NOTE: Terminal bend radii and lead-in manufacturing option.

**AV2** VERTICAL RIGHT ANGLE, PC THRU-HOLE, .150" PITCH



**E221SD1AV2GE DPDT**

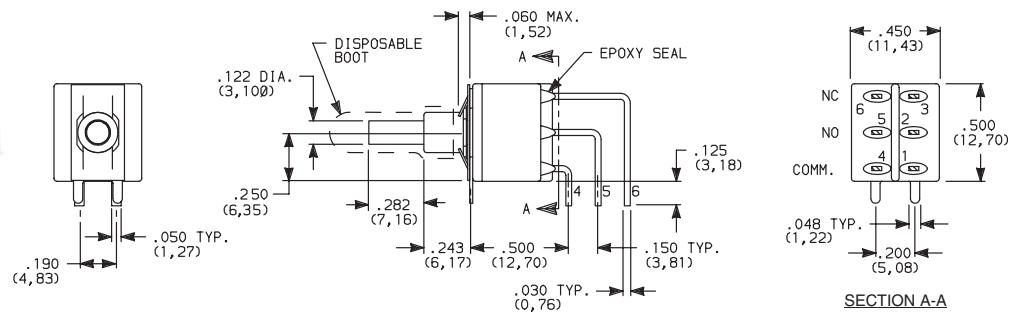

**AV3** VERTICAL RIGHT ANGLE, SNAP-IN, PC THRU-HOLE, .150" PITCH

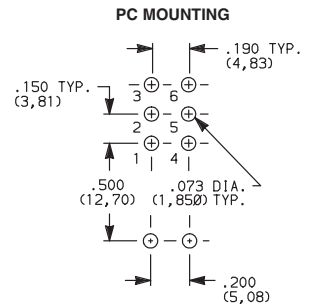
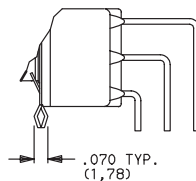
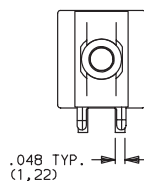

NOTE: Terminal bend radii and lead-in manufacturing option.



Dimensions are shown: Inches (mm)  
Specifications and dimensions subject to change

# C&K E020 Series Sealed Snap-acting Momentary Pushbutton Switches

## TERMINATIONS



**V3, V4** VERTICAL MOUNT, V-BRACKET

**V31, V41** VERTICAL MOUNT, V-BRACKET, SNAP-IN

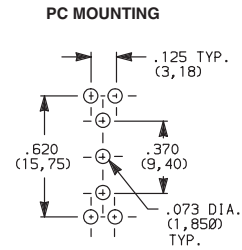
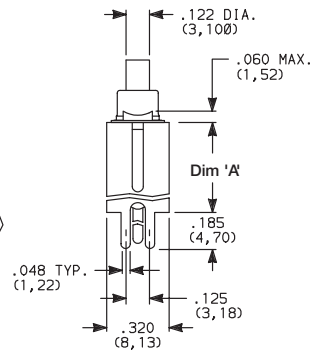
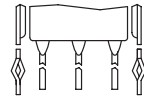
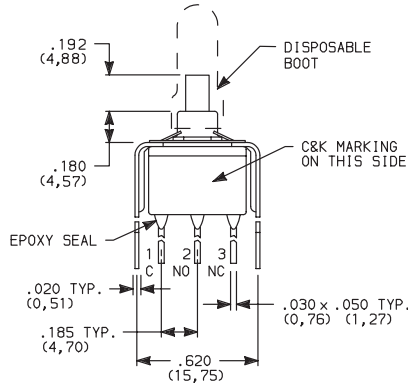

**E121SD3\_GE  
SPDT**

OPTION CODE	DIM 'A'
<b>V3, V31</b>	.460 (11,68)
<b>V4, V41</b>	.630 (16,00)

**V3, V4** VERTICAL MOUNT, V-BRACKET

**V31, V41** VERTICAL MOUNT, V-BRACKET, SNAP-IN

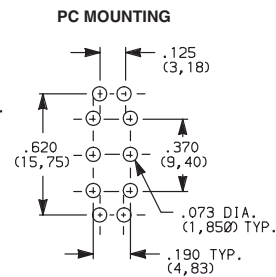
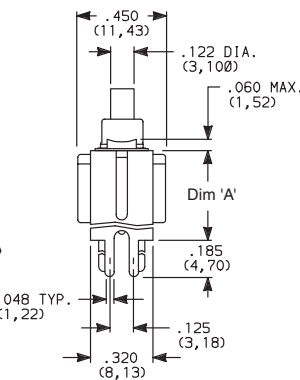
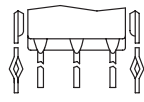
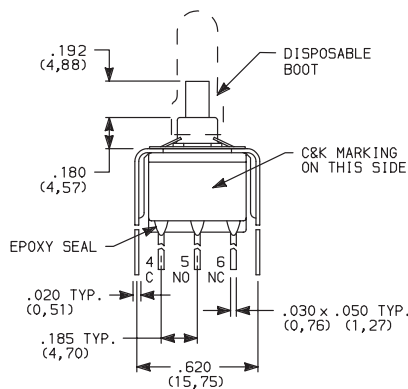

**E221SD3\_GE  
DPDT**

OPTION CODE	DIM 'A'
<b>V3, V31</b>	.460 (11,68)
<b>V4, V41</b>	.630 (16,00)

**V6, V8** VERTICAL MOUNT, V-BRACKET

**V61, V81** VERTICAL MOUNT, V-BRACKET, SNAP-IN

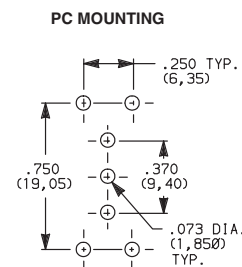
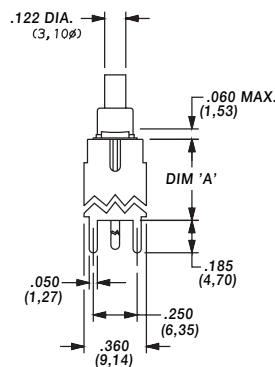
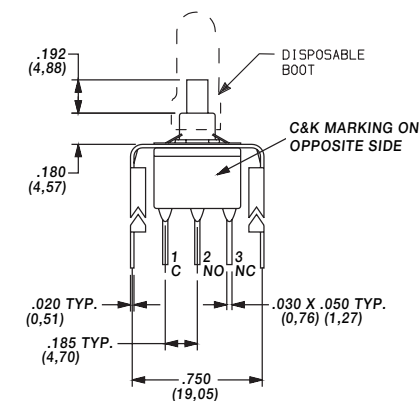

**E121SD3V\_GE  
SPDT**

OPTION CODE	DIM 'A'
<b>V6, V61</b>	.460 (11,68)
<b>V8, V81</b>	.953 (24,21)

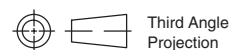

Dimensions are shown: Inches (mm)  
Specifications and dimensions subject to change





# C&K E020 Series Sealed Snap-acting Momentary Pushbutton Switches

## TERMINATIONS

A

Pushbutton

**V6, V8** VERTICAL MOUNT, V-BRACKET

**V61, V81** VERTICAL MOUNT, V-BRACKET, SNAP-IN



E221SD3V6GE DPDT

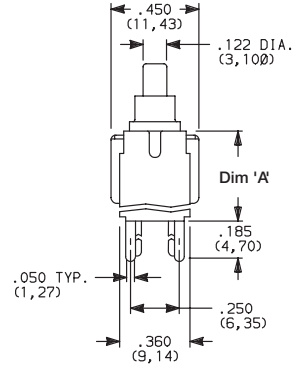
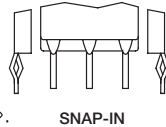
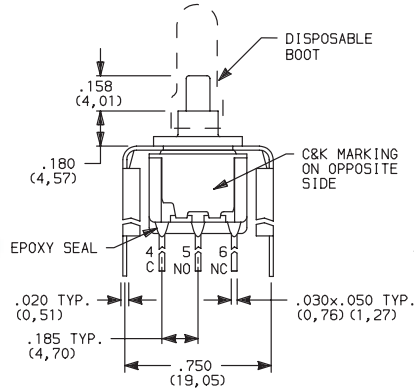

### PC MOUNTING

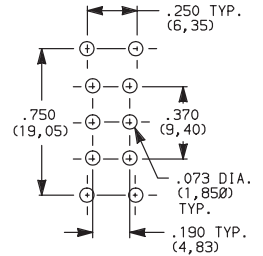

OPTION CODE	DIM 'A'
<b>V6, V61</b>	.460 (11,68)
<b>V8, V81</b>	.953 (24,21)

## CONTACT MATERIAL

OPTION CODE	RoHS COMPLIANT *	RoHS COMPATIBLE *	CONTACT MATERIAL	TERMINAL PLATING	RATINGS	
<b>B</b>	YES	YES	GOLD <sup>1</sup>	GOLD <sup>1</sup>	LOW LEVEL/DRY CIRCUIT	EX25 MODELS ONLY: 0.4 VA MAX. @ 20 V AC OR DC MAX.
<b>K</b>	NO	YES		TIN-LEAD <sup>4</sup>		
<b>P</b>	YES	YES		MATTE-TIN <sup>5</sup>		
<b>G</b>	YES	YES	GOLD OVER SILVER <sup>2,3</sup>	GOLD <sup>3</sup>	LOW LEVEL/DRY CIRCUIT OR POWER	EX21 MODELS ONLY: 0.4 VA MAX @ 20 V AC OR DC MAX. OR 1 AMP @ 120 V AC OR 28 V DC.
<b>L</b>	NO	YES		TIN-LEAD <sup>4</sup>		
<b>R</b>	YES	YES		MATTE-TIN <sup>5</sup>		

\* Note: See Technical Data section of this catalog for RoHS compliant and compatible definitions and specifications.

<sup>1</sup> CONTACTS & TERMINALS: Copper alloy, with gold plate over nickel plate.

<sup>2</sup> N.O. AND N.C. CONTACTS: Coin silver, with gold plate over nickel plate.

<sup>3</sup> COMMON CONTACTS & ALL TERMINALS: Copper alloy, with gold plate over nickel plate.

<sup>4</sup> TERMINALS: Copper alloy, with tin-lead alloy over nickel plate.

<sup>5</sup> TERMINALS: Copper alloy, with matte-tin alloy over nickel plate.

**NOTE:** Any models supplied with P, R, B or G contact material are RoHS compliant. For the latest information regarding RoHS compliance, please go to: [www.itccannon.com/rohs](http://www.itccannon.com/rohs).

E121, E221 models with all options when ordered with mandatory G, R or L contact material.

P, B or K contact material must be ordered with EX25 models.

R, G or L contact material must be ordered with EX21 models.

## SEAL

**E** EPOXY SEAL AND DISPOSABLE SPLASHPROOF BOOT

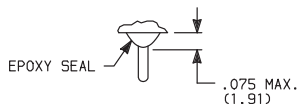

Disposable splashproof boot supplied standard. Remove and discard boot *only after* soldering and cleaning processes are complete.

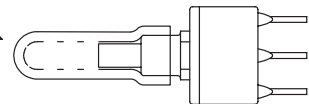

Dimensions are shown: Inches (mm)  
Specifications and dimensions subject to change

# C&K E020 Series Sealed Snap-acting Momentary Pushbutton Switches

## AVAILABLE HARDWARE

Cap

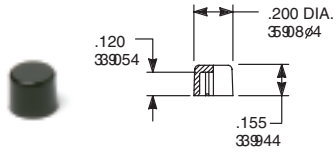

**PART NO.**

- 708901000** WHITE
- 708902000** BLACK
- 708903000** RED

Material: Nylon  
Finish: Gloss

Cap

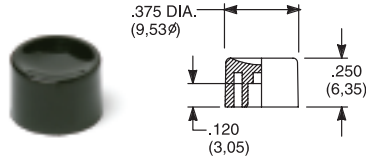

**PART NO.**

- 752701000** WHITE
- 752702000** BLACK
- 752703000** RED

Material: Nylon  
Finish: Gloss

Cap

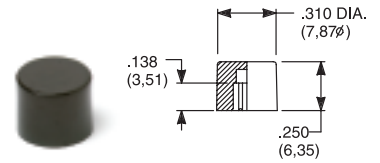

**PART NO.**

- 801801000** WHITE
- 801802000** BLACK
- 801803000** RED

Material: Nylon  
Finish: Gloss

Cap, Snap-fitting plunger

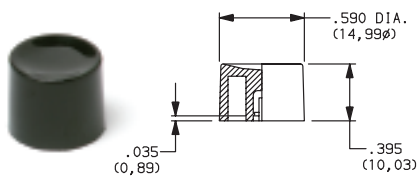

**PART NO.**

- 894001000** WHITE
- 894002000** BLACK
- 894003000** RED

Material: Nylon  
Finish: Gloss

Cap, Snap-fitting plunger

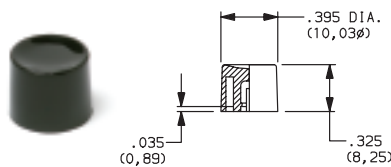

**PART NO.**

- 894101000** WHITE
- 894102000** BLACK
- 894103000** RED

Material: Nylon  
Finish: Gloss

Cap

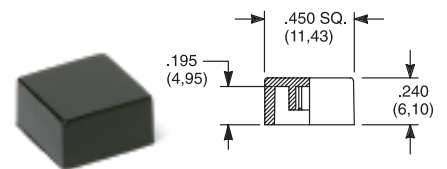

**PART NO.**

- 484601000** WHITE
- 484602000** BLACK
- 484603000** RED

Material: Nylon  
Finish: Gloss

**PART NO.**

- 798201000** WHITE
- 798202263** BLACK
- 798203000** RED

Material: Nylon  
Finish: Matte

**NOTE:** Other cap colors available9consult Customer Service Center.

Frames snap into panel opening and are independent from switch mounting. Accurate positioning of the PC mounted switch relative to the panel opening is necessary to provide proper clearance between actuator and frame. Available in two basic styles and four panel thicknesses .047-.125 in. Material: Nylon. Finish: Matte.

**TYPICAL APPLICATION**

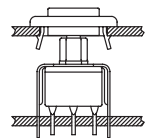

.047" (1,19) PANEL THK.

.062" (1,57) PANEL THK.

.090" (2,29) PANEL THK.

.125" (3,18) PANEL THK.

**PART NO.**

- 432501000**
- 432502263**
- 432503000**

**PART NO.**

- 432601000**
- 432602263**
- 432603000**

**PART NO.**

- 432701000**
- 432702263**
- 432703000**

**PART NO.**

- 432801000** WHITE
- 432802263** BLACK
- 432803000** RED

**PANEL MOUNTING**

For part numbers  
4325xxxxx, 4326xxxxx

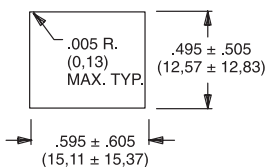

For part numbers  
4327xxxxx, 4328xxxxx

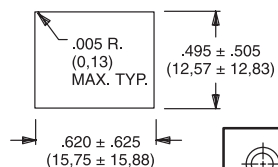

Dimensions are shown: Inches (mm)

Specifications and dimensions subject to change





# C&K E020 Series Sealed Snap-acting Momentary Pushbutton Switches

## AVAILABLE HARDWARE

A

Pushbutton

### PANEL INSERTS

Above frames (part nos. 432XXXXXX) are also available with insert which accepts LED for indicator light assembly. Order insert separately from frame. Blank insert panel (without hole for LED) also available. **LED not included.**

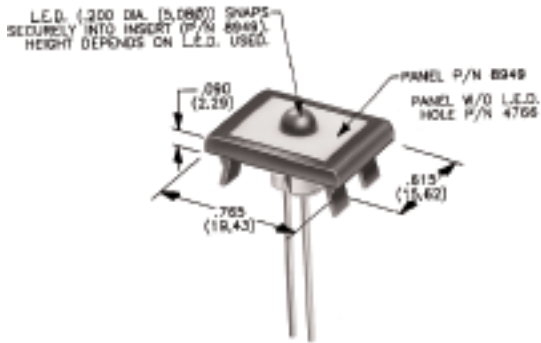

PANEL INSERT  
WITH HOLE FOR LED

BLANK PANEL INSERT  
WITHOUT HOLE FOR LED

**PART NO.**

**894901000**  
**894902000**  
**894903000**

**PART NO.**

**476601000** WHITE  
**476602000** BLACK  
**476603000** RED

Special colors, custom markings available, consult Customer Service Center.



Dimensions are shown: Inches (mm)  
Specifications and dimensions subject to change