

SKT 24



Stud Thyristor

Line Thyristor

SKT 24

Features

- Hermetic metal case with glass insulator
- Threaded stud ISO M6 or UNF 1/4-28
- International standard case

Typical Applications

- DC motor control (e. g. for machine tools)
- Controlled rectifiers (e. g. for battery charging)
- AC controllers (e. g. for temperature control)
- Recommended snubber network e. g. for $V_{VRMS} \leq 400$ V:
 $R = 100 \Omega / 5$ W, $C = 0,1 \mu F$

1) Available with UNF thread 1/4-28 UNF2A, e. g. SKT 24/12E UNF

| V_{RSM} V | V_{RRM}, V_{DRM} V | $I_{TRMS} = 50$ A (maximum value for continuous operation) $I_{TAV} = 24$ A (sin. 180; $T_c = 95$ °C) | |
|----------------|-------------------------|--|--|
| 500 | 400 | SKT 24/04D | |
| 900 | 800 | SKT 24/08D | |
| 1300 | 1200 | SKT 24/12E ¹⁾ | |
| 1500 | 1400 | SKT 24/14E | |
| 1700 | 1600 | SKT 24/16E ¹⁾ | |
| 1900 | 1800 | SKT 24/18E | |

| Symbol | Conditions | Values | Units |
|------------------|---|--------------------|------------------|
| I_{TAV} | sin. 180; $T_c = 100$ (85) °C | 22 (29) | A |
| I_D | K5; $T_a = 45$ °C; B2 / B6 K3; $T_a = 45$ °C; B2 / B6 | 22 / 30 28 / 40 | A |
| I_{RMS} | K5; $T_a = 45$ °C; W1C | 24 | A |
| I_{TSM} | $T_{vj} = 25$ °C; 10 ms $T_{vj} = 130$ °C; 10 ms | 450 380 | A |
| i^2t | $T_{vj} = 25$ °C; 8,35 ... 10 ms $T_{vj} = 130$ °C; 8,35 ... 10 ms | 1000 720 | A ² s |
| V_T | $T_{vj} = 25$ °C; $I_T = 75$ A | max. 1,9 | V |
| $V_{T(TO)}$ | $T_{vj} = 130$ °C | 1 | V |
| r_T | $T_{vj} = 130$ °C | 10 | mΩ |
| I_{DD}, I_{RD} | $T_{vj} = 130$ °C; $V_{RD} = V_{RRM}; V_{DD} = V_{DRM}$ | max. 8 | mA |
| t_{gd} | $T_{vj} = 25$ °C; $I_G = 1$ A; $di_G/dt = 1$ A/μs | 1 | μs |
| t_{gr} | $V_D = 0,67 * V_{DRM}$ | 2 | μs |
| $(di/dt)_{cr}$ | $T_{vj} = 130$ °C | max. 50 | A/μs |
| $(dv/dt)_{cr}$ | $T_{vj} = 130$ °C; SKT ...D / SKT ...E | max. 500 / 1000 | V/μs |
| t_q | $T_{vj} = 130$ °C | 80 | μs |
| I_H | $T_{vj} = 25$ °C; typ. / max. | 80 / 150 | mA |
| I_L | $T_{vj} = 25$ °C; typ. / max. | 150 / 300 | mA |
| V_{GT} | $T_{vj} = 25$ °C; d.c. | min. 3 | V |
| I_{GT} | $T_{vj} = 25$ °C; d.c. | min. 100 | mA |
| V_{GD} | $T_{vj} = 130$ °C; d.c. | max. 0,25 | V |
| I_{GD} | $T_{vj} = 130$ °C; d.c. | max. 3 | mA |
| $R_{th(j-c)}$ | cont. | 0,8 | K/W |
| $R_{th(j-c)}$ | sin. 180 | 0,9 | K/W |
| $R_{th(j-c)}$ | rec. 120 | 0,95 | K/W |
| $R_{th(c-s)}$ | | 0,5 | K/W |
| T_{vj} | | - 40 ... + 130 | °C |
| T_{stg} | | - 40 ... + 150 | °C |
| V_{isol} | | - | V~ |
| M_s | to heatsink | 2,5 | Nm |
| a | | 5 * 9,81 | m/s ² |
| m | approx. | 12 | g |
| Case | | B 2 | |



SKT

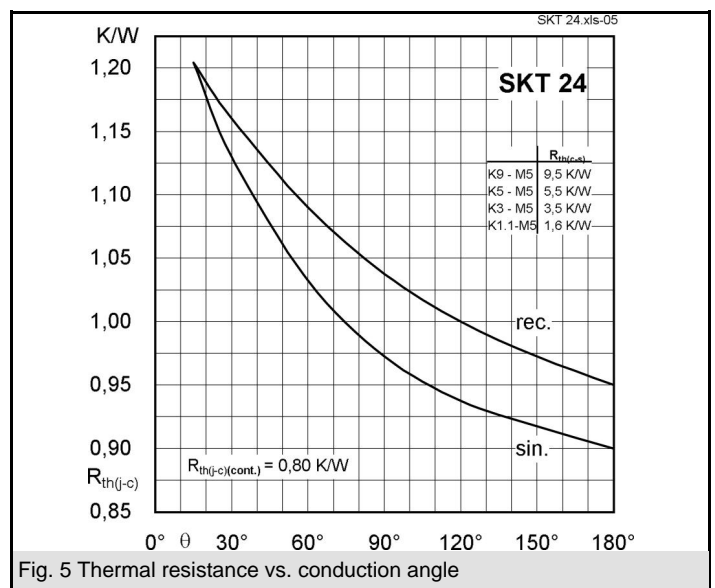
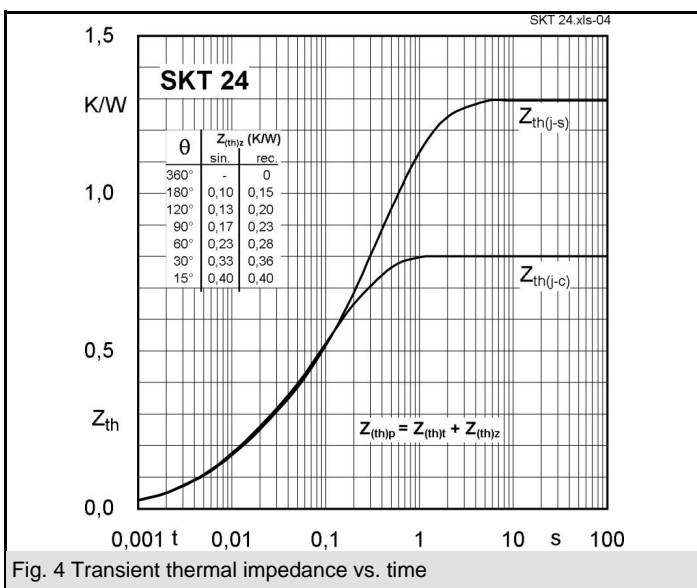
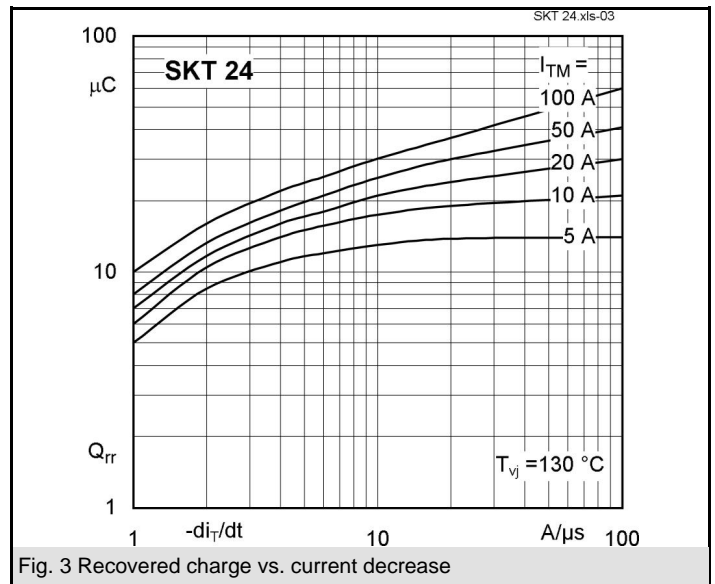
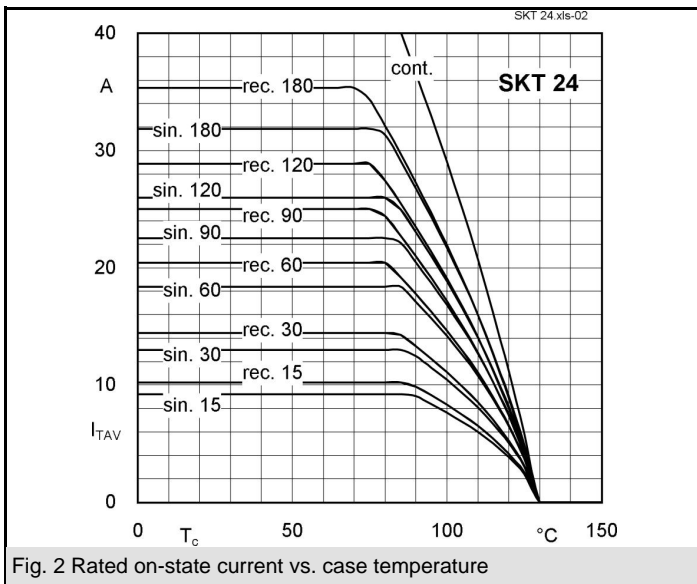
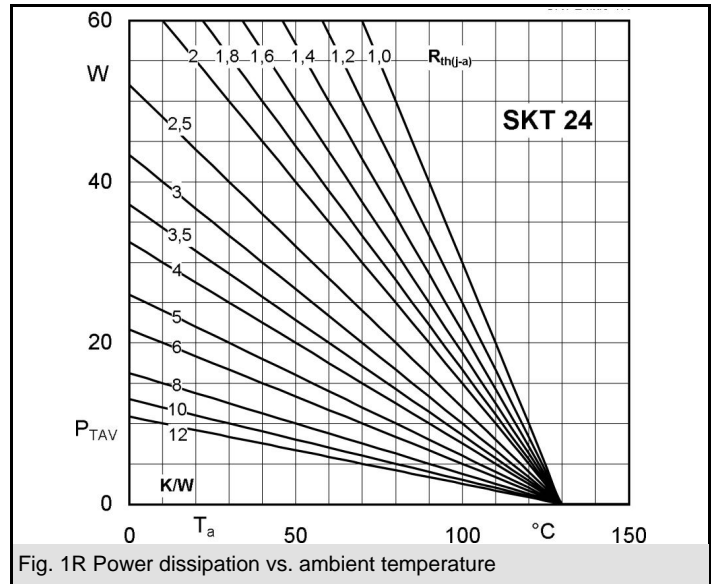
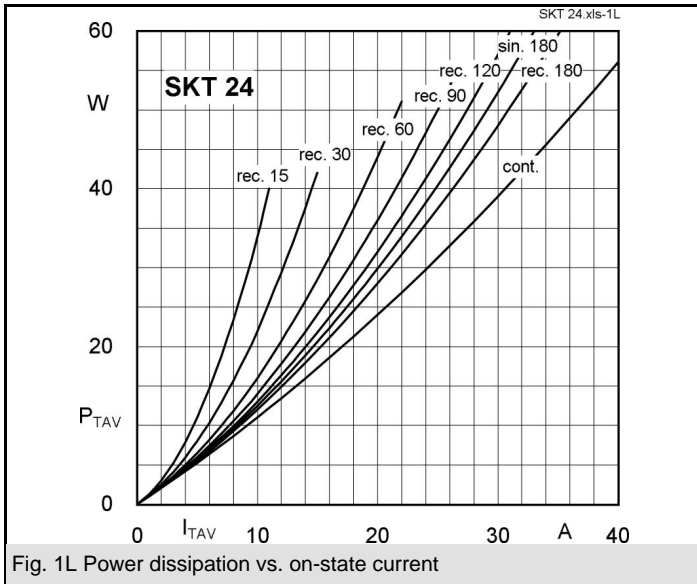

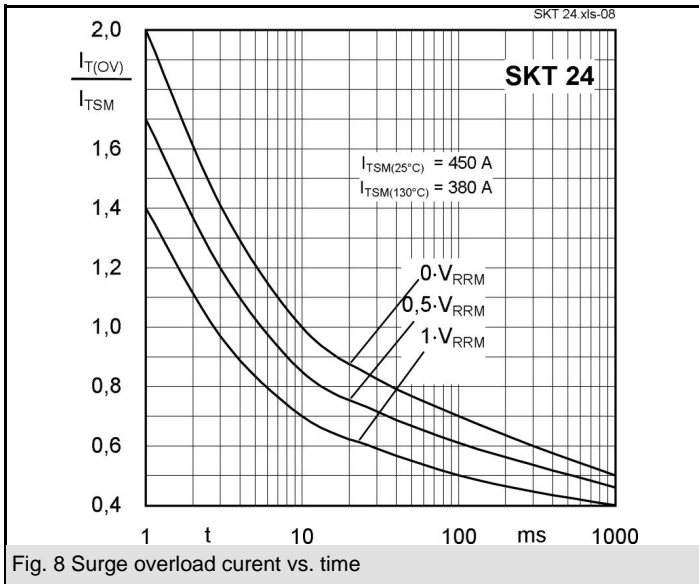
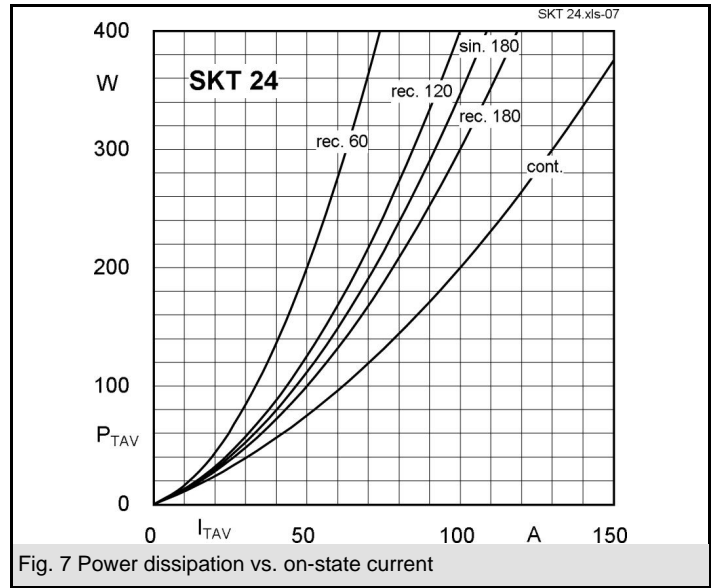
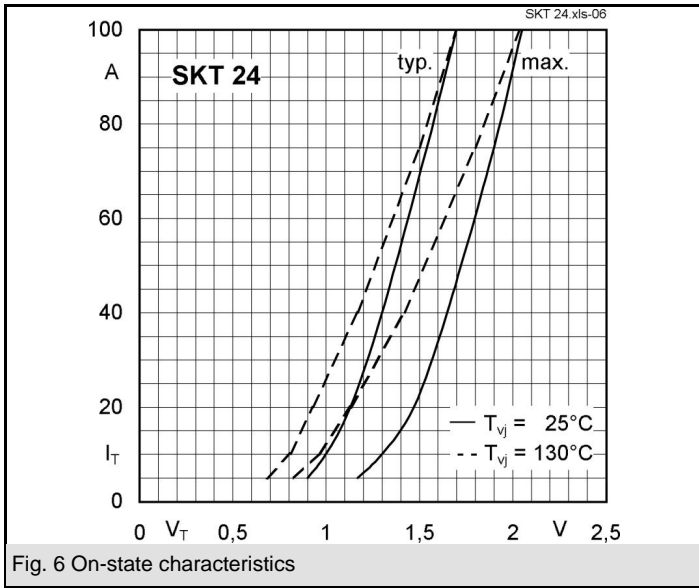

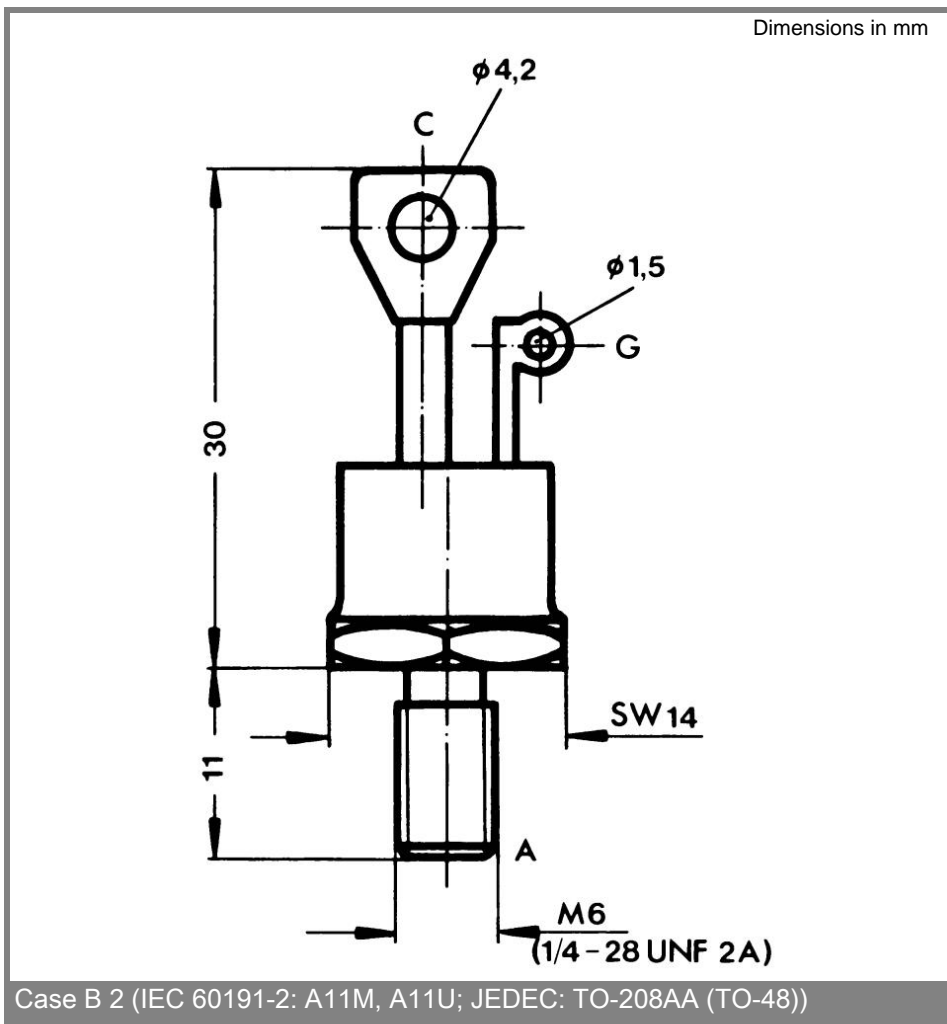
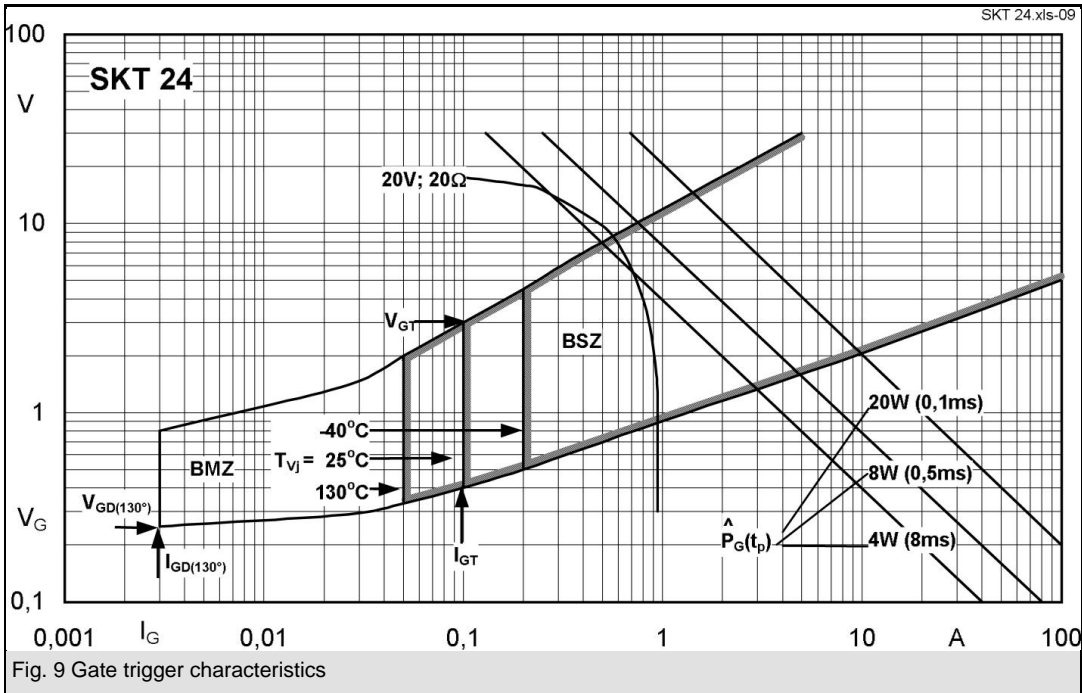

This technical information specifies semiconductor devices but promises no characteristics. No warranty or guarantee expressed or implied is made regarding delivery, performance or suitability.