

KM7101

Ultra-Low Cost, 136 μ A, 4.9MHz Rail-to-Rail I/O Amplifier

Features

- 136 μ A supply current
- 4.9MHz bandwidth
- Output swings to within 20mV of either rail
- Input voltage range exceeds the rail by >250mV
- 5.3V/ μ s slew rate
- 16mA output current
- 21nV/ $\sqrt{\text{Hz}}$ input voltage noise
- Directly replaces LMC7101 in single supply applications
- Available in SOT23-5 package

Applications

- Portable/battery-powered applications
- PCMCIA, USB
- Mobile communications, cellular phones, pagers
- Notebooks and PDA's
- Sensor Interface
- A/D buffer
- Active filters
- Signal conditioning
- Portable test instruments

KM7101 Package

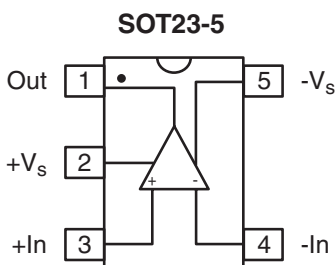

Description

The KM7101 is an ultra-low cost, low power, voltage feedback amplifier that is pin compatible to the LMC7101. If a standard pinout is required, use the KM4170. The KM7101 uses only 136 μ A of supply current and offers no crossover distortion. The input common mode voltage range exceeds the negative and positive rails.

The KM7101 offers high bipolar performance at a low CMOS price. The KM7101 offers superior dynamic performance with a 4.9MHz small signal bandwidth and 5.3V/ μ s slew rate. The combination of low power, high bandwidth, and rail-to-rail performance make the KM7101 well suited for battery-powered communication/computing systems.

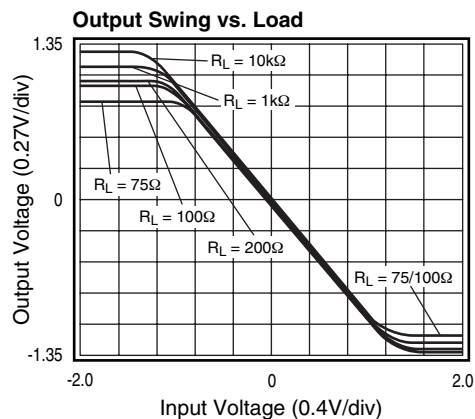
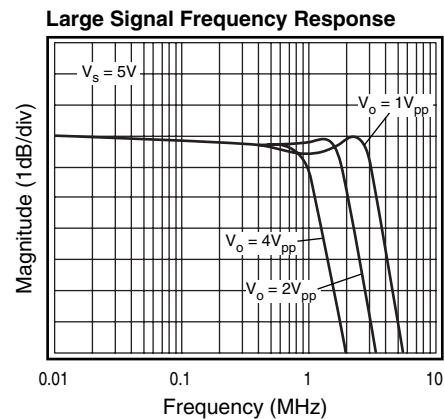

Absolute Maximum Ratings

Parameter	Min.	Max.	Unit
Supply Voltages	0	+6	V
Maximum Junction Temperature	–	+175	°C
Storage Temperature Range	-65	+150	°C
Lead Temperature, 10 seconds	–	+260	°C
Operating Temperature Range, recommended	-40	+85	°C
Input Voltage Range	$-V_S - 0.5$	$+V_S + 0.5$	V
I_{out} Continuous	-30	+30	mA

Electrical Specifications

($V_S = +2.7V$, $G = 2$, $R_L = 10k\Omega$ to $V_S/2$, $R_f = 5k\Omega$; unless otherwise noted)

Parameter	Conditions	Min.	Typ.	Max.	Unit
AC Performance					
-3dB Bandwidth ¹	$G = +1$, $V_o = 0.02V_{pp}$		4.9		MHz
	$G = +2$, $V_o = 0.2V_{pp}$		3.7		MHz
Full Power Bandwidth	$G = +2$, $V_o = 2V_{pp}$		1.4		MHz
Gain Bandwidth Product			2.2		MHz
Rise and Fall Time	1V step		163		ns
Overshoot	1V step		<1		%
Slew Rate	1V step		5.3		V/ μ s
2nd Harmonic Distortion	$1V_{pp}$, 10kHz		-72		dBc
3rd Harmonic Distortion	$1V_{pp}$, 10kHz		-72		dBc
THD	$1V_{pp}$, 10kHz		0.03		%
Input Voltage Noise	>10kHz		21		nV/ \sqrt{Hz}
DC Performance					
Input Offset Voltage ²		-6	0.5	+6	mV
Average Drift			5		μ V/°C
Input Bias Current ²			90	420	nA
Average Drift			32		pA/°C
Power Supply Rejection Ratio ²	DC	55	83		dB
Open Loop Gain	$R_L = 10k\Omega$		90		dB
Quiescent Current Per Channel ²			136	190	μ A
Input Characteristics					
Input Resistance			12		M Ω
Input Capacitance			2		pF
Input Common Mode Voltage Range			-0.25 to 2.95		V
Common Mode Rejection Ratio ²	DC, $V_{cm} = 0V$ to V_S	55	81		dB
Output Characteristics					
Output Voltage Swing ²	$R_L = 10k\Omega$ to $V_S/2$	0.06 to 2.64	0.02 to 2.68		V
	$R_L = 1k\Omega$ to $V_S/2$		0.05 to 2.63		V
	$R_L = 200\Omega$ to $V_S/2$		0.11 to 2.52		V
Output Current			± 16		mA
Power Supply Operating Range		2.5	2.7	5.5	V

Min/max ratings are based on product characterization and simulation. Individual parameters are tested as noted. Outgoing quality levels are determined from tested parameters.

Notes:

- For $G = +1$, $R_f = 0$.
- For $R_L = 10k\Omega$, 100% tested at 25°C.

Electrical Specifications

($V_S = +5V$, $G = 2$, $R_L = 10k\Omega$ to $V_S/2$, $R_f = 5k\Omega$; unless otherwise noted)

Parameter	Conditions	Min.	Typ.	Max.	Unit
AC Performance					
-3dB Bandwidth ¹	$G = +1$, $V_O = 0.02V_{pp}$		4.3		MHz
	$G = +2$, $V_O = 0.2V_{pp}$		3.0		MHz
Full Power Bandwidth	$G = +2$, $V_O = 2V_{pp}$		2.3		MHz
Gain Bandwidth Product			2.0		MHz
Rise and Fall Time	1V step		110		ns
Overshoot	1V step		<1		%
Slew Rate	1V step		9		V/ μ s
2nd Harmonic Distortion	$1V_{pp}$, 10kHz		-73		dBc
3rd Harmonic Distortion	$1V_{pp}$, 10kHz		-75		dBc
THD	$1V_{pp}$, 10kHz		0.03		%
Input Voltage Noise	>10kHz		22		nV/ \sqrt{Hz}
DC Performance					
Input Offset Voltage ²		-8	1.5	+8	mV
Average Drift			15		μ V/ $^{\circ}$ C
Input Bias Current ²			90	450	nA
Average Drift			40		pA/ $^{\circ}$ C
Power Supply Rejection Ratio ²	DC	40	60		dB
Open Loop Gain	$R_L = 10k\Omega$		80		dB
Quiescent Current Per Channel ²			160	235	μ A
Input Characteristics					
Input Resistance			12		M Ω
Input Capacitance			2		pF
Input Common Mode Voltage Range			-0.25 to 5.25		V
Common Mode Rejection Ratio ²	DC, $V_{cm} = 0V$ to V_S	58	85		dB
Output Characteristics					
Output Voltage Swing ²	$R_L = 10k\Omega$ to $V_S/2$	0.08 to 4.92	0.04 to 4.96		V
	$R_L = 1k\Omega$ to $V_S/2$		0.07 to 4.9		V
	$R_L = 200\Omega$ to $V_S/2$		0.14 to 4.67		V
Output Current			± 30		mA
Power Supply Operating Range		2.5	2.7	5.5	V

Min/max ratings are based on product characterization and simulation. Individual parameters are tested as noted. Outgoing quality levels are determined from tested parameters.

Notes:

- For $G = +1$, $R_f = 0$.
- For $R_L = 10k\Omega$, 100% tested at 25 $^{\circ}$ C.

Package Thermal Resistance

Package	θ_{JA}
5 lead SOT23	256 $^{\circ}$ C/W

Typical Operating Characteristics

($V_S = +2.7V$, $G = 2$, $R_L = 10k\Omega$ to $V_S/2$, $R_f = 5k\Omega$; unless otherwise noted)

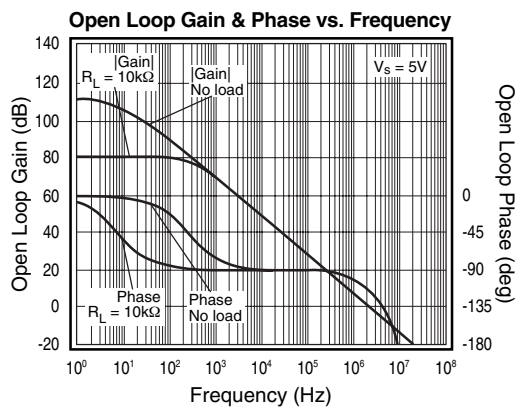
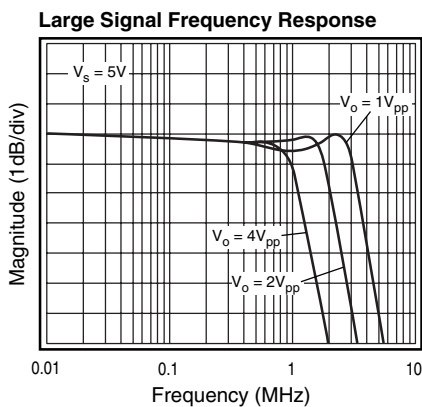
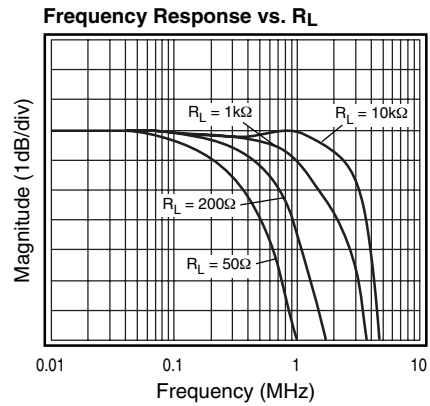
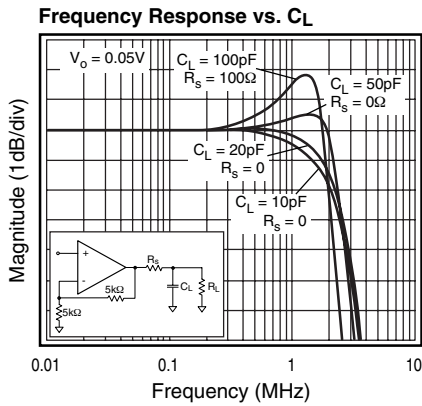
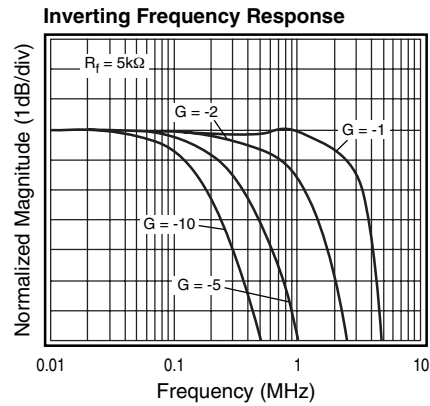
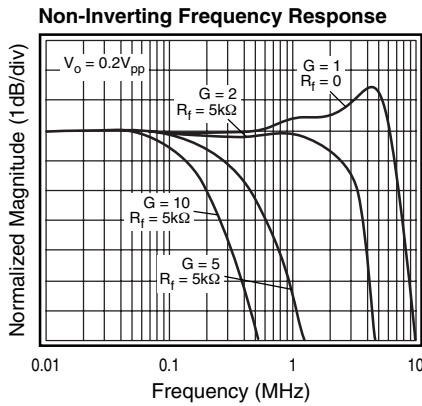
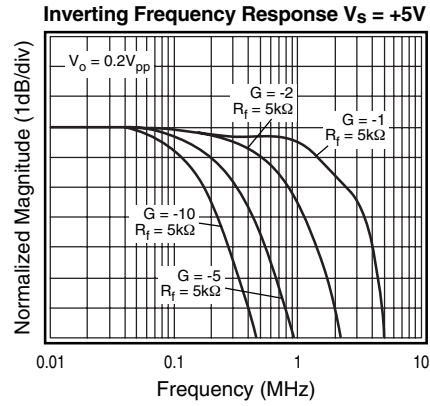
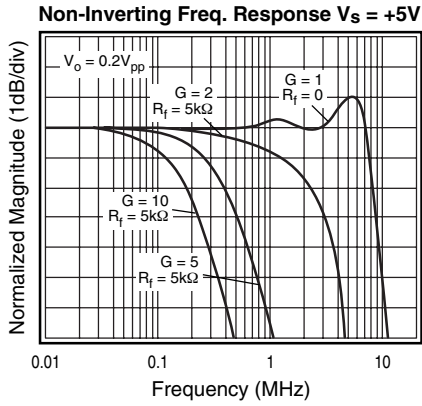

Typical Operating Characteristics

($V_S = +2.7V$, $G = 2$, $R_L = 10k\Omega$ to $V_S/2$, $R_f = 5k\Omega$; unless otherwise noted)

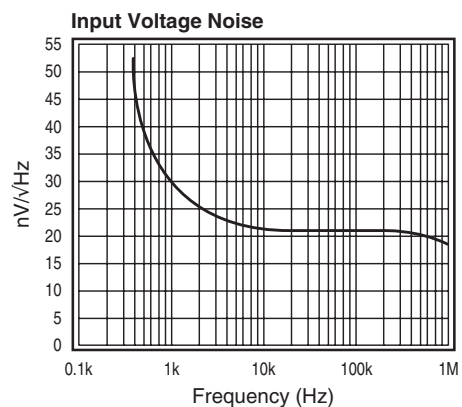
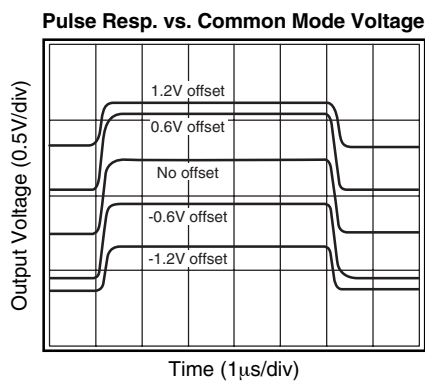
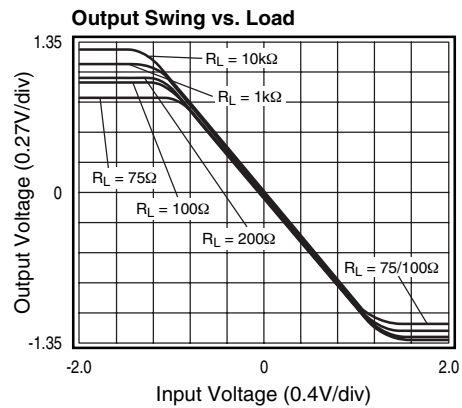
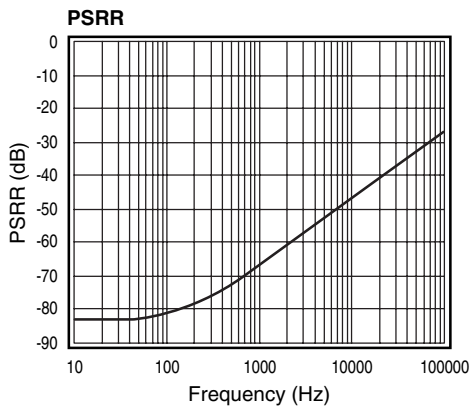
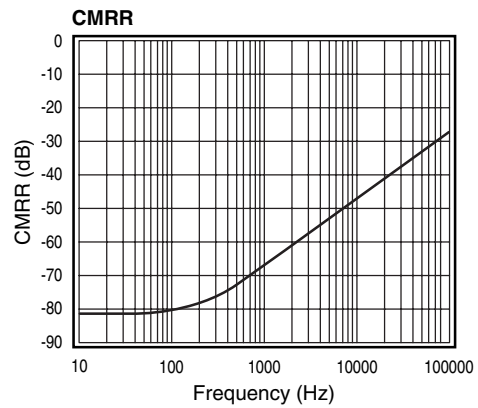
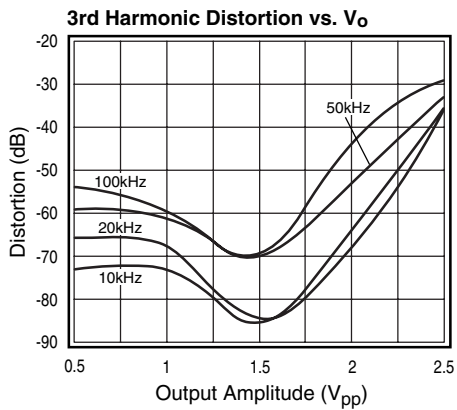
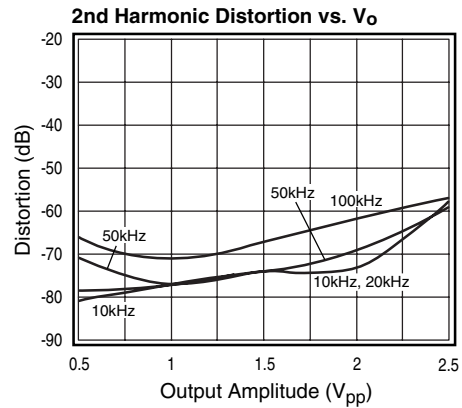
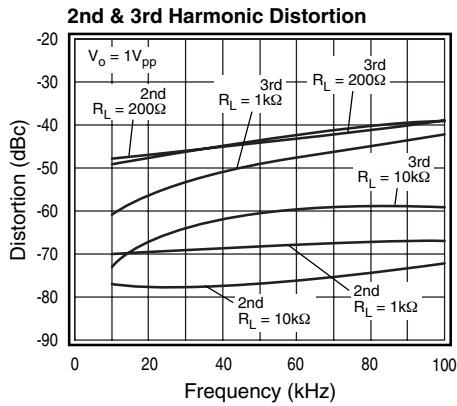

Application Information

General Description

The KM7101 is single supply, general purpose, voltage feedback amplifier that is pin-for-pin compatible with the National Semiconductor LMC7101. The KM7101 is fabricated on a complementary bipolar process, features a rail-to-rail input and output, and is unity gain stable.

The typical non-inverting circuit schematic is shown in Figure 1.

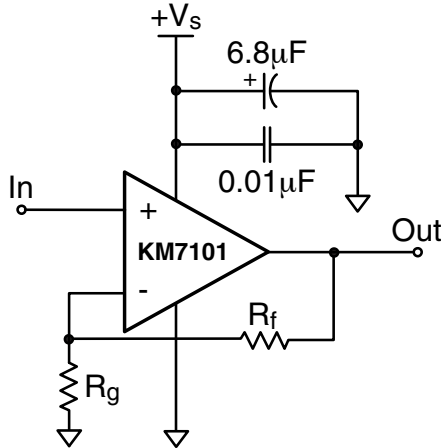

Figure 1: Typical Non-inverting Configuration

Input Common Mode Voltage

The common mode input range extends to 250mV below ground and to 250mV above V_s , in single supply operation. Exceeding these values will not cause phase reversal. However, if the input voltage exceeds the rails by more than 0.5V, the input ESD devices will begin to conduct. The output will stay at the rail during this overdrive condition. If the absolute maximum input voltage (700mV beyond either rail) is exceeded, externally limit the input current to $\pm 5\text{mA}$ as shown in Figure 2.

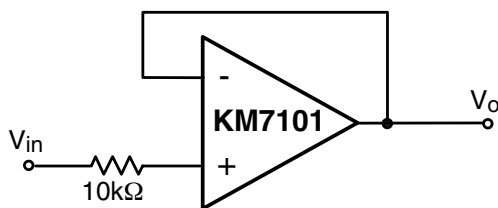

Figure 2: Circuit for Input Current Protection

Power Dissipation

The maximum internal power dissipation allowed is directly related to the maximum junction temperature. If the maximum junction temperature exceeds 150°C, some performance degradation will occur. If the maximum junction temperature exceeds 175°C for an extended time, device failure may occur.

Overdrive Recovery

Overdrive of an amplifier occurs when the output and/or input ranges are exceeded. The recovery time varies based on whether the input or output is overdriven and by how much the ranges are exceeded. The KM7101 will typically recover in less than 50ns from an overdrive condition. Figure 3 shows the KM7101 in an overdriven condition.

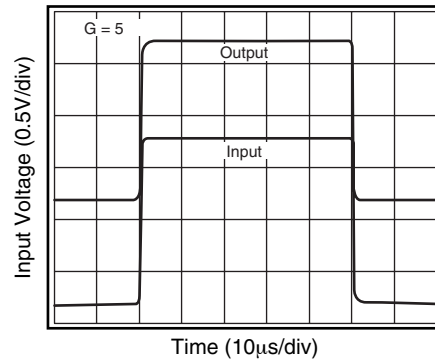
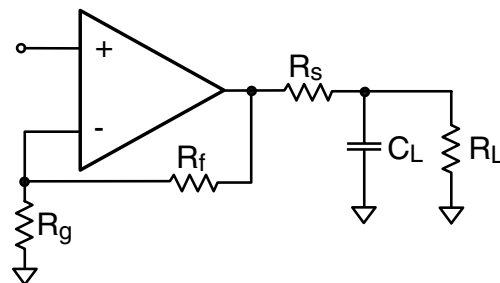

Figure 3: Overdrive Recovery

Driving Capacitive Loads

The *Frequency Response vs. C_L* plot, illustrates the response of the KM7101. A small series resistance (R_s) at the output of the amplifier, illustrated in Figure 4, will improve stability and settling performance. R_s values in the *Frequency Response vs. C_L* plot were chosen to achieve maximum bandwidth with less than 2dB of peaking. For maximum flatness, use a larger R_s . Capacitive loads larger than 50pF require the



use of R_s .

Figure 4: Typical Topology for driving a capacitive load

Driving a capacitive load introduces phase-lag into the output signal, which reduces phase margin in the amplifier. The unity gain follower is the most sensitive configuration. In a unity gain follower configuration, the KM7101 requires a 510Ω series resistor to drive a 100pF load.

Layout Considerations

General layout and supply bypassing play major roles in high frequency performance. Fairchild has evaluation boards to use as a guide for high frequency layout and as aid in device testing and characterization. Follow the steps below as a basis for high frequency layout:

- Include 6.8μF and 0.01μF ceramic capacitors
- Place the 6.8μF capacitor within 0.75 inches of the power pin
- Place the 0.01μF capacitor within 0.1 inches of the power pin
- Remove the ground plane under and around the part, especially near the input and output pins to reduce parasitic capacitance
- Minimize all trace lengths to reduce series inductances

Refer to the evaluation board layouts shown in Figure 6 for more information.

Evaluation Board Information

The following evaluation boards are available to aid in the testing and layout of this device:

Eval Bd	Description	Products
KEB008	Single Channel, Dual Supply SOT23-5 for KM7101 type pinout	KM7101IT5

Evaluation board schematics and layouts are shown in Figure

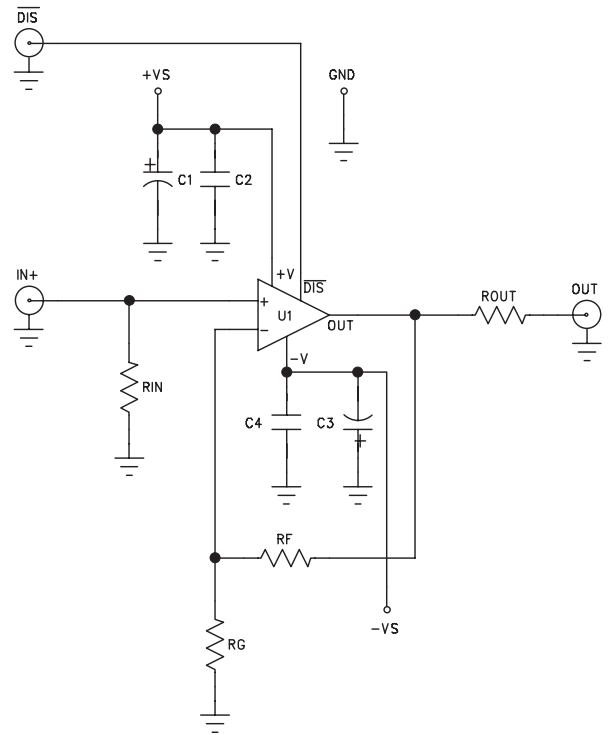

5 and Figure 6.

Figure 5: Evaluation Board Schematic

KM7101 Evaluation Board Layout

KOTA LAYER1 SILK

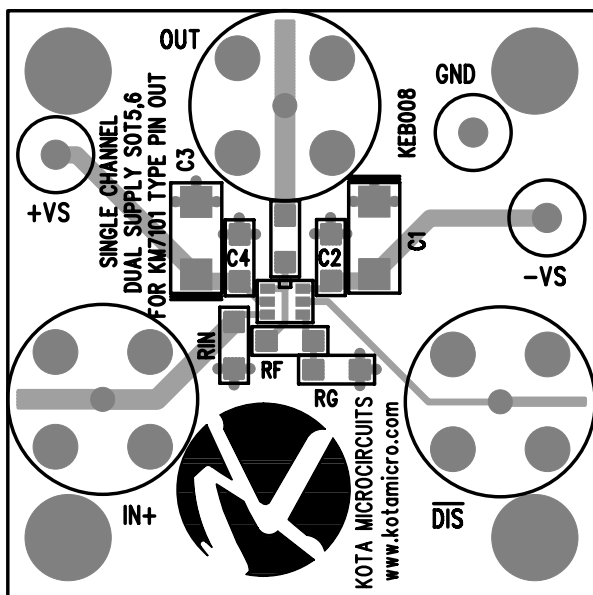

KOTA LAYERS SILK

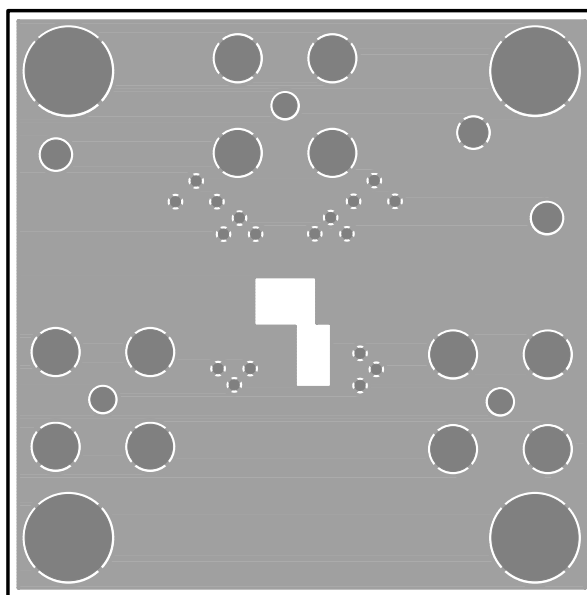
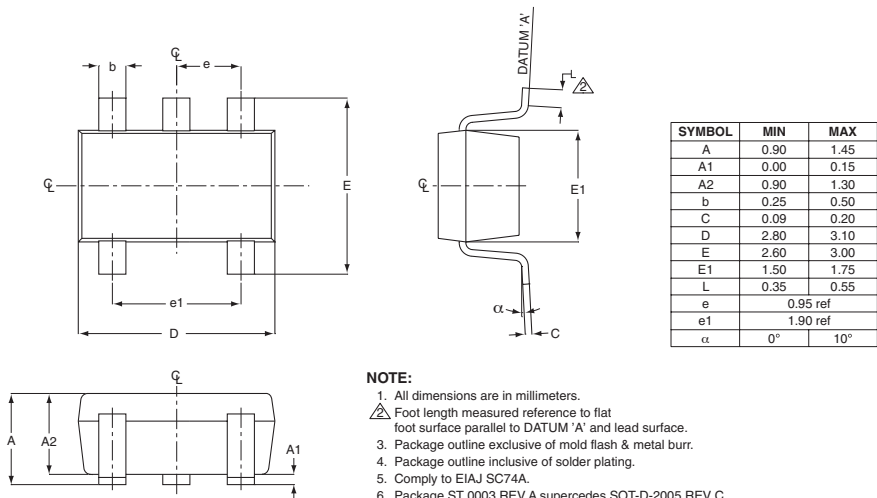

Figure 6a: KEB008 (top side)

Figure 6b: KEB008 (bottom side)

KM7101 Package Dimensions

SOT23-5



Ordering Information

Model	Part Number	Package	Container	Pack Qty
KM7101	KM7101IT5TR3	SOT23-5	Reel	3000

Temperature range for all parts: -40°C to +85°C.

DISCLAIMER

FAIRCHILD SEMICONDUCTOR RESERVES THE RIGHT TO MAKE CHANGES WITHOUT FURTHER NOTICES TO ANY PRODUCTS HEREIN TO IMPROVE RELIABILITY, FUNCTION OR DESIGN. FAIRCHILD DOES NOT ASSUME ANY LIABILITY ARISING OUT OF THE APPLICATION OR USE OF ANY PRODUCT OR CIRCUIT DESCRIBED HEREIN; NEITHER DOES IT CONVEY ANY LICENSE UNDER ITS PATENT RIGHTS, NOR THE RIGHTS OF OTHERS.

LIFE SUPPORT POLICY

FAIRCHILD'S PRODUCTS ARE NOT AUTHORIZED FOR USE AS CRITICAL COMPONENTS IN LIFE SUPPORT DEVICES OR SYSTEMS WITHOUT THE EXPRESS WRITTEN APPROVAL OF THE PRESIDENT OF FAIRCHILD SEMICONDUCTOR CORPORATION. As used herein:

1. Life support devices or systems are devices or systems which, (a) are intended for surgical implant into the body, or (b) support or sustain life, and (c) whose failure to perform when properly used in accordance with instructions for use provided in the labeling, can be reasonably expected to result in a significant injury of the user.
2. A critical component in any component of a life support device or system whose failure to perform can be reasonably expected to cause the failure of the life support device or system, or to affect its safety or effectiveness.