

Features

- Temperature-compensated: 50 ppm/°C
- 0.25% to 2.0% bandgap offered
- Internal amplifier with 150 mA capability
- Multiple temperature ranges
- Low frequency dynamic output impedance: < 150 mΩ
- Low output noise

Description

The AS432 is a three terminal adjustable shunt regulator utilizing an accurate 1.24V bandgap reference. The AS432 is functionally similar to an AS431 except for its lower reference voltage, making it usable in a wide variety of low voltage applications.

Because of its robust bipolar technology, the AS432 handles a wide range of current, and holds off more than 18V so its use is not limited to low power, low voltage systems. Significant care has been taken to provide adequate AC bandwidth to allow the AS432 as an amplifier in control systems and power electronics.

Pin Configuration — Top view

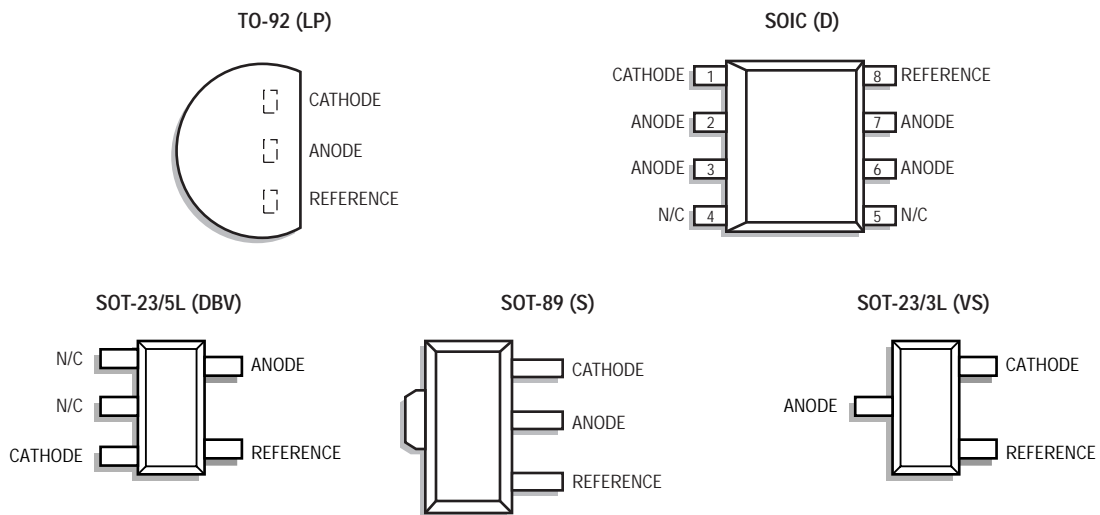

Ordering Information

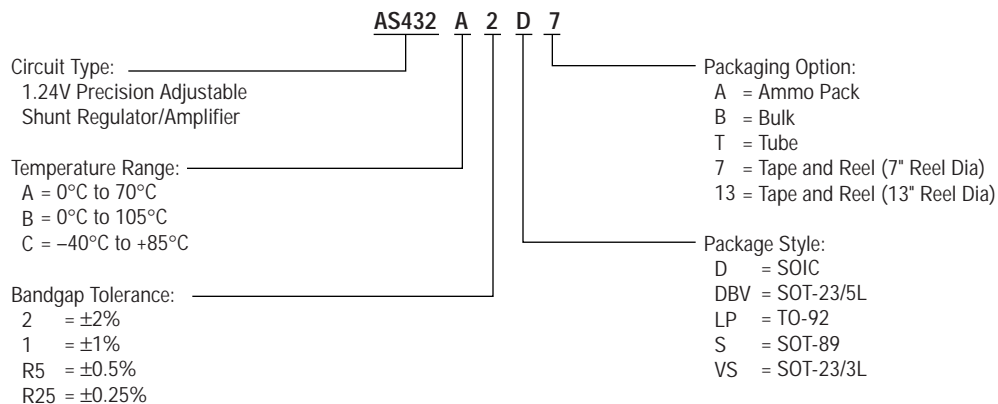

Functional Block Diagram

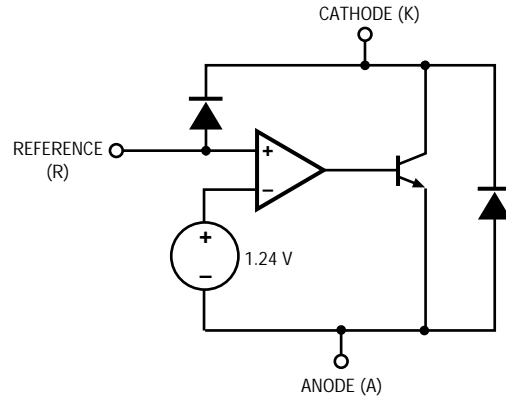

Absolute Maximum Ratings

Parameter	Symbol	Rating	Units
Cathode-Anode Reverse Breakdown	V_{KA}	18	V
Anode-Cathode Forward Current	I_{AK}	1	A
Operating Cathode Current	I_{KA}	100	mA
Reference Input Current	I_{REF}	1	mA
Continuous Power at 25°C	P_D		
TO-92		775	mW
8L SOIC		750	mW
SOT-89		1000	mW
SOT-23/3L/5L		200	mW
Junction Temperature	T_J	150	°C
Storage Temperature	T_{STG}	-65 to 150	°C
Lead Temperature (Soldering 10 sec.)	T_L	300	°C

Stresses greater than those listed under ABSOLUTE MAXIMUM RATINGS may cause permanent damage to the device. This is a stress rating only and functional operation of the device at these or any other conditions above those indicated in the operational sections of this specification is not implied. Exposure to absolute maximum rating conditions for extended periods may affect reliability.

Recommended Conditions

Parameter	Symbol	Rating	Unit
Cathode Voltage	V_{KA}	V_{REF} to 18	V
Cathode Current	I_K	10	mA

Typical Thermal Resistances

Package	θ_{JA}	θ_{JC}	Typical Derating
TO-92	160°C/W	80°C/W	6.3 mW/°C
SOIC	175°C/W	45°C/W	5.7 mW/°C
SOT-89	110°C/W	8°C/W	9.1 mW/°C
SOT-23/3L/5L	575°C/W	150°C/W	1.7 mW/°C

Electrical Characteristics

Electrical characteristics are guaranteed over the full junction temperature range (0–105°C). Ambient temperature must be derated based upon power dissipation and package thermal characteristics. Unless otherwise stated, test conditions are: $V_{KA} = V_{REF}$ and $I_K = 10$ mA.

Parameter	Symbol	Test Condition	AS432 (0.25%)			AS432 (0.5%)			Unit
			Min.	Typ.	Max.	Min.	Typ.	Max.	
Output Voltage	V_{REF}	$I_K = 10$ mA $T_J = 25^\circ\text{C}$ $V_K = V_{REF}$	1.237	1.240	1.243	1.234	1.240	1.246	V
Line Regulation	ΔV_{REF}	$V_{KA} = 1.25$ to 15 V		28	50		28	50	mV
Load Regulation	ΔV_{REF}	$I_K = 1$ to 100 mA		3.9	6		3.9	6	mV
Temperature Deviation	ΔV_{REF}	$0 < T_J < 105^\circ\text{C}$		5	10		5	10	mV
Reference Input Current	I_{REF}			2.3	6		2.3	6	μA
Reference Input Current Temperature Coefficient	ΔI_{REF}	$0 < T_J < 105^\circ\text{C}$		0.14	0.6		0.14	0.6	μA
Minimum Cathode Current for Regulation	$I_{K(\min)}$			0.2	1		0.2	1	mA
Off State Leakage	$I_{K(\min)}$	$V_{REF} = 0$ V, $V_{KA} = 15$ V		0.04	500		0.04	500	nA

Parameter	Symbol	Test Condition	AS432 (1.0%)			AS432 (2.0%)			Unit
			Min.	Typ.	Max.	Min.	Typ.	Max.	
Output Voltage	V_{REF}	$I_K = 10$ mA $T_J = 25^\circ\text{C}$ $V_K = V_{REF}$	1.228	1.240	1.252	1.215	1.240	1.256	V
Line Regulation	ΔV_{REF}	$V_{KA} = 1.25$ to 15 V		28	50		28	50	mV
Load Regulation	ΔV_{REF}	$I_K = 1$ to 100 mA		3.9	6		3.9	6	mV
Temperature Deviation	ΔV_{REF}	$0 < T_J < 105^\circ\text{C}$		5	12		5	12	mV
Reference Input Current	I_{REF}			2.3	6		2.3	6	μA
Reference Input Current Temperature Coefficient	ΔI_{REF}	$0 < T_J < 105^\circ\text{C}$		0.14	0.6		0.14	0.6	μA
Minimum Cathode Current for Regulation	$I_{K(\min)}$			0.2	1		0.2	1	mA
Off State Leakage	$I_{K(\min)}$	$V_{REF} = 0$ V, $V_{KA} = 15$ V		0.04	500		0.04	500	nA

*Temperature deviation is defined as the maximum deviation of the reference over the given temperature range and does not imply an incremental deviation at any given temperature.

Typical Performance Curves

*Calculating Average Temperature Coefficient (TC)

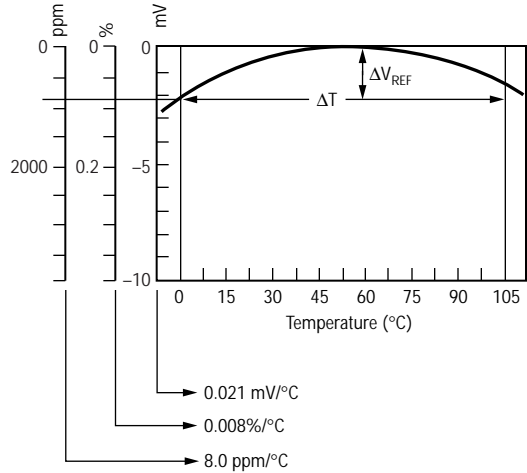

- TC in mV/°C = $\frac{\Delta V_{REF} \text{ (mV)}}{\Delta T_A}$
- TC in %/°C = $\frac{\left(\frac{\Delta V_{REF}}{V_{REF} \text{ at } 25^\circ\text{C}}\right) \times 100}{\Delta T_A}$
- TC in ppm/°C = $\frac{\left(\frac{\Delta V_{REF}}{V_{REF} \text{ at } 25^\circ\text{C}}\right) \times 10^6}{\Delta T_A}$

Test Circuits

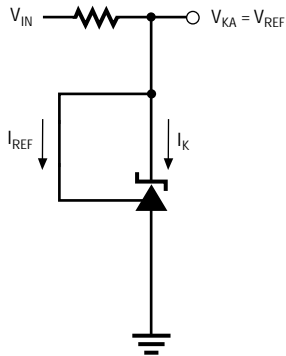

Figure 1a. Test Circuit 1

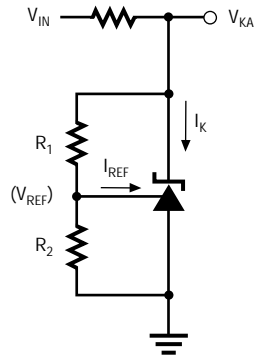

Figure 1b. Test Circuit 2

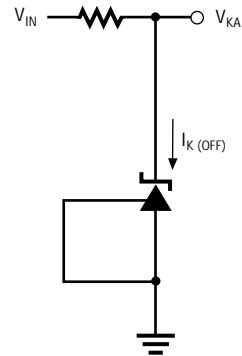

Figure 1c. Test Circuit 3

Typical Performance

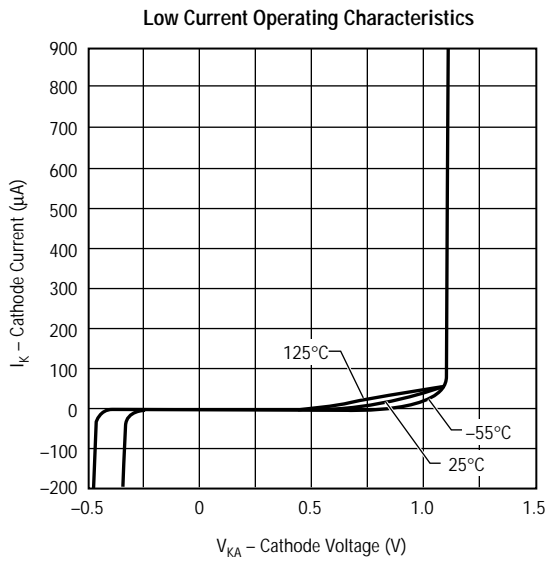

Figure 2

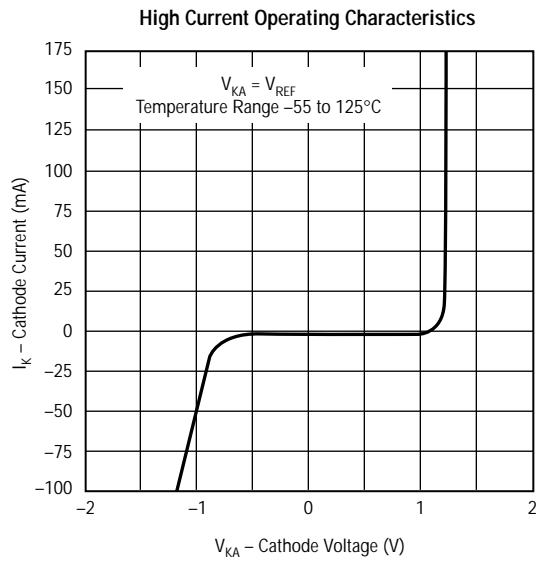

Figure 3

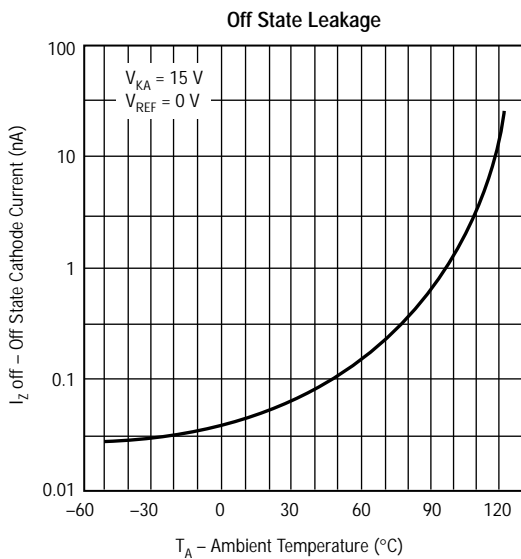

Figure 4

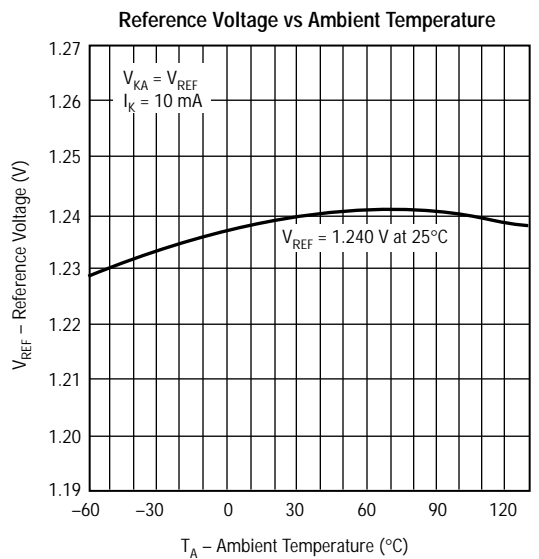

Figure 5

Typical Performance Curves

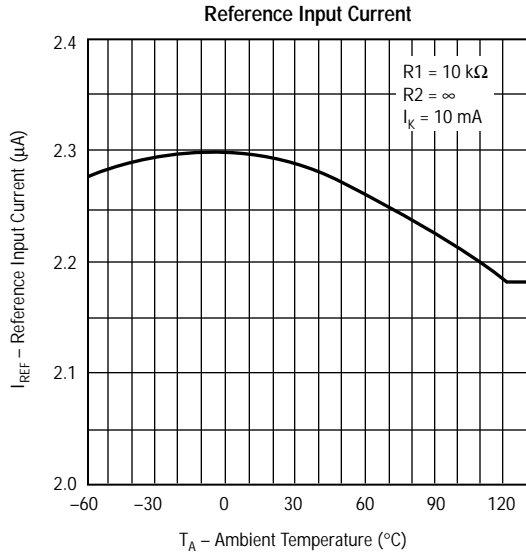

Figure 6

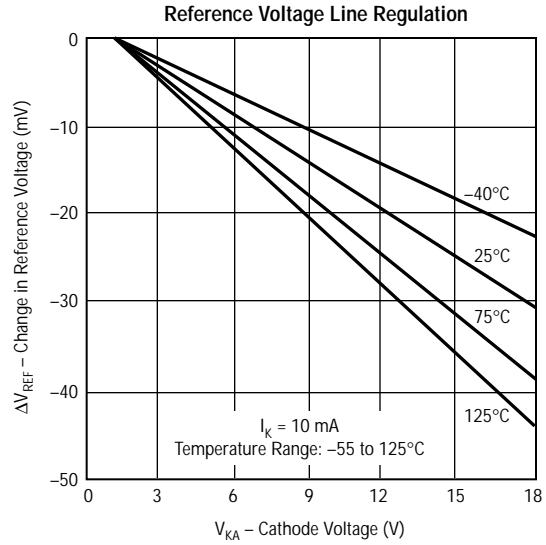

Figure 7

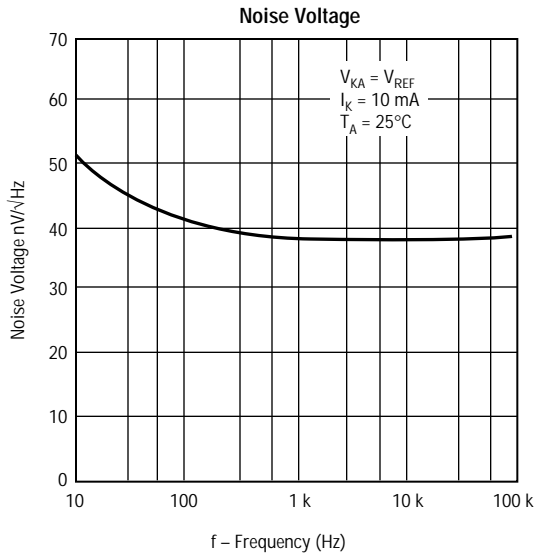

Figure 8

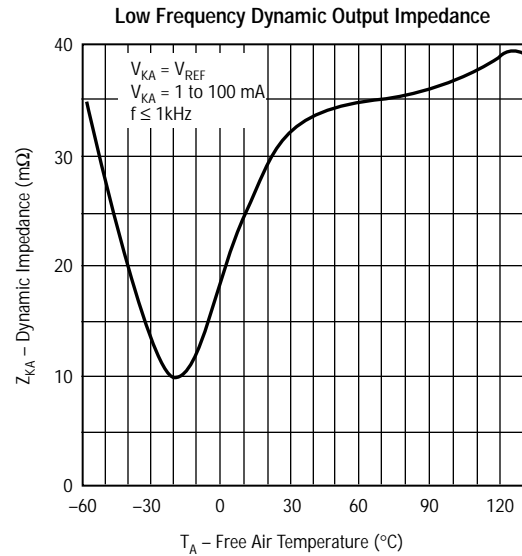

Figure 9

Typical Performance Curves

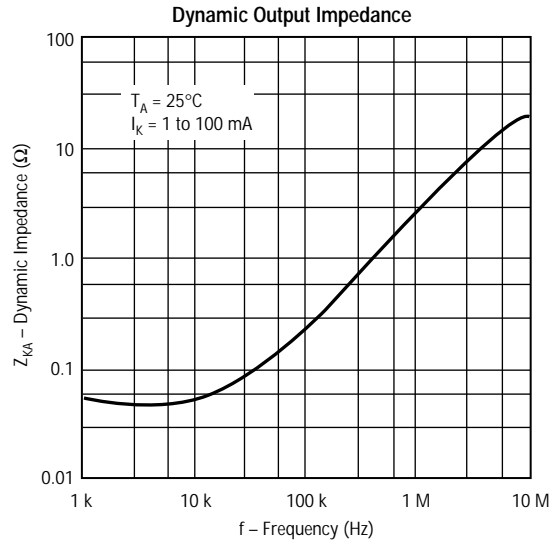

Figure 10

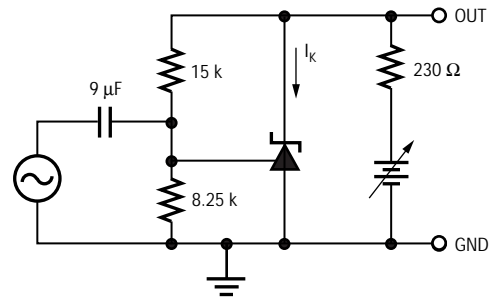
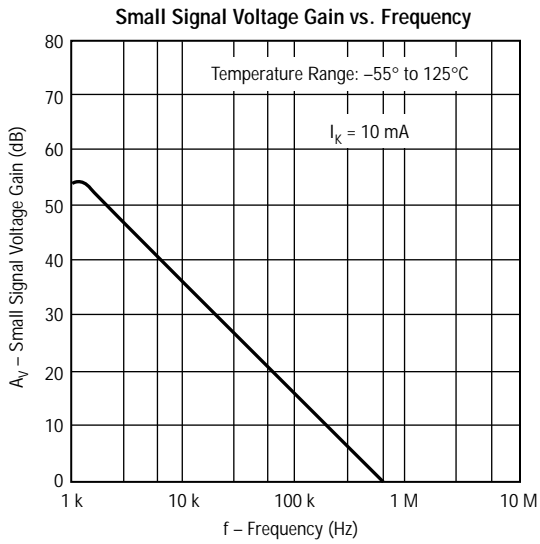

Figure 11

Typical Performance Curves

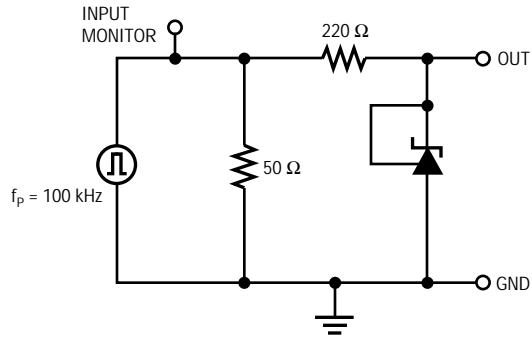
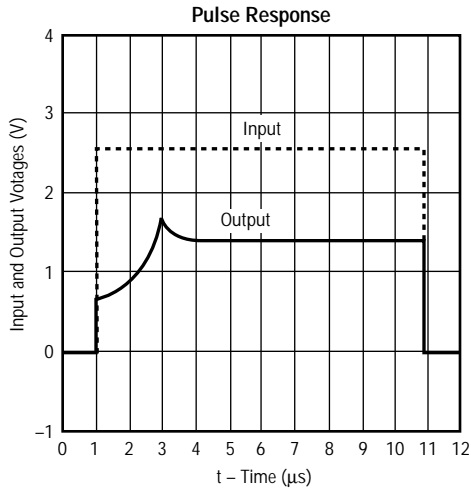

Figure 12

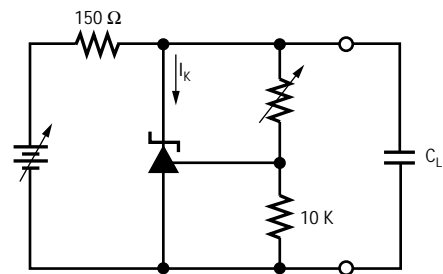
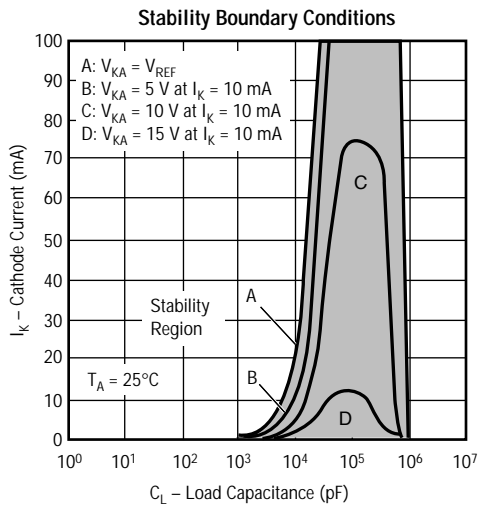

Figure 13