

MAFL-010140-CT0C60



MoCA Triplex Filter 5 - 2000 MHz

Rev. V3

Features

- 75 Ohm
- SMT unit
- RoHS Compliant
- Lead Free

Description

- M/A-COM Technology Solutions's MAFL-010140-CT0C60 is a surface mount Triplex Filter unit designed for MoCA applications.

Ordering Information

Part Number	Package
MAFL-010140-CT0C60	Tray Qty: 960

Functional Schematic

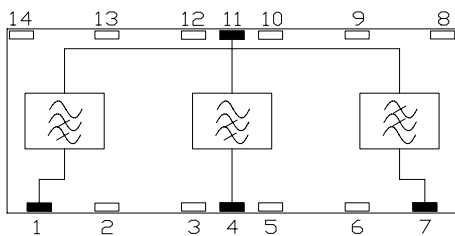

Electrical Specifications: $T_A = 25^\circ\text{C}$, $Z_0 = 75\Omega$

Parameter	Units	Typ	Min	Max
Input Port Return Loss				
5 - 42MHz	dB	-15	-12	-
54 - 1002MHz	dB	-12	-10	-
1125 - 1525 MHz	dB	-12	-10	-
Reverse Path Filter:				
5 - 42MHz	dB	-1.2	-	-1.5
54 - 64 MHz	dB	-62	-60	-
64 - 210 MHz	dB	-48	-45	-
210 - 450 MHz	dB	-40	-37.5	-
450 - 1002 MHz	dB	-32	-28	-
Forward Path Filter:				
5 - 40MHz	dB	-55	-50	-
40 - 42 MHz	dB	-50	-47.5	-
54 - 88 MHz	dB	-1.5	-	-2.0
88 - 800 MHz	dB	-1.0	-	-1.5
800 - 1002 MHz	dB	-2.0	-	-2.5
1125 - 1200 MHz	dB	-40	-37	-
1200 - 1400 MHz	dB	-28	-26	-
1400 - 1500 MHz	dB	-37	-33	-
1500 - 2000 MHz	dB	-30	-26	-
MoCA Path Filter:				
5 - 750MHz	dB	-50	-45	-
750 - 1002MHz	dB	-42	-40	-
1125 - 1525MHz	dB	-2.0	-	-3.0
2000MHz	dB	-35	-30	-

Product Image

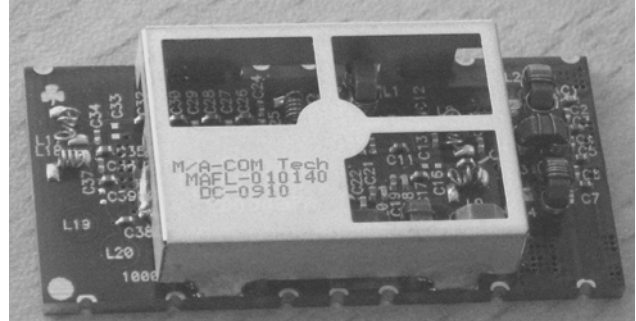

Pin Configuration

Function	Pin Number
RF IN (Common Port)	11
Return Path Port	7
Forward Path Port	4
MoCA Path Port	1
Ground	2,3,5,6,8,9,10,12,13,14

Recommended Maximum Ratings

Parameter	Value
Storage Temperature	-40°C to +85°C
Operating Temperature	-40°C to +85°C
DC Current	30mA
RF Power	250mW

- Full temperature plots are available upon request.

1

ADVANCED: Data Sheets contain information regarding a product M/A-COM Technology Solutions is considering for development. Performance is based on target specifications, simulated results, and/or prototype measurements. Commitment to develop is not guaranteed.

PRELIMINARY: Data Sheets contain information regarding a product M/A-COM Technology Solutions has under development. Performance is based on engineering tests. Specifications are typical. Mechanical outline has been fixed. Engineering samples and/or test data may be available. Commitment to produce in volume is not guaranteed.

- North America Tel: 800.366.2266
- Europe Tel: +353.21.244.6400
- India Tel: +91.80.4155721
- China Tel: +86.21.2407.1588

Visit www.macontech.com for additional data sheets and product information.

M/A-COM Technology Solutions Inc. and its affiliates reserve the right to make changes to the product(s) or information contained herein without notice.

Outline Drawing: SM-198

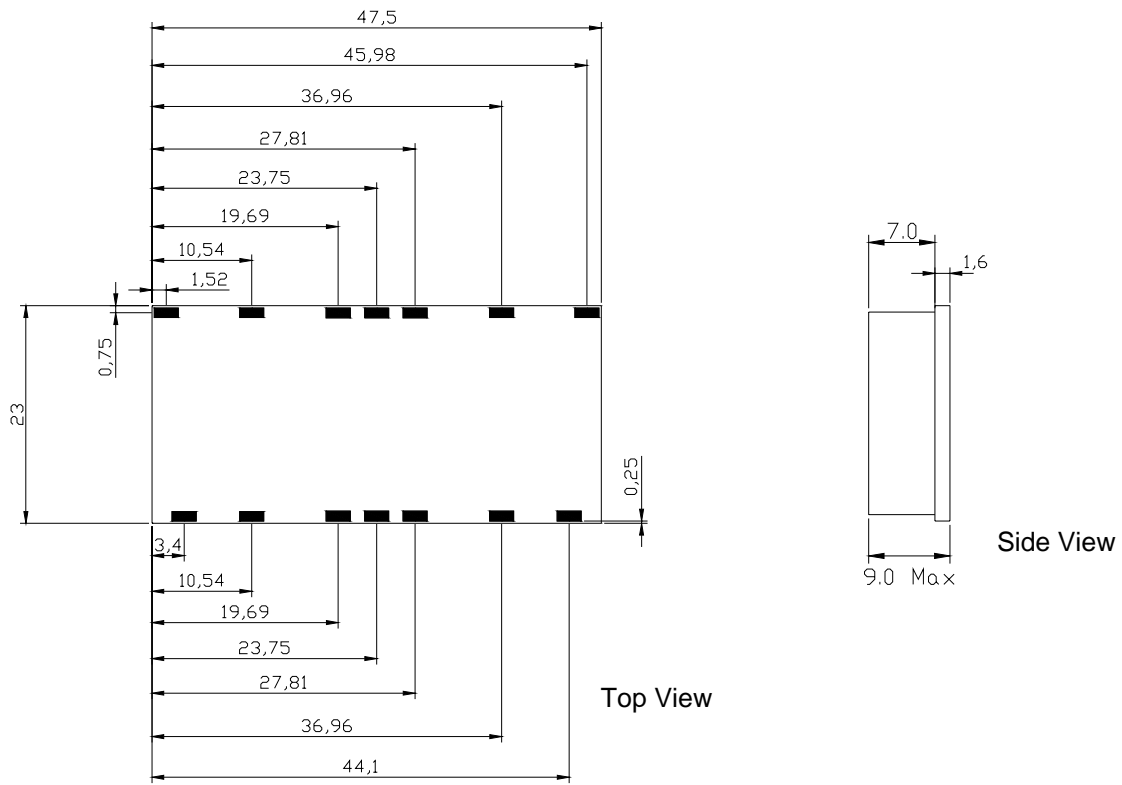

Recommended PCB Configuration

- Track dimension = 1.15mm
- Gap dimension = 1.3mm
- It is not recommended to run tracks under the filter unless they are greater than 1.6mm below the base.
- Ground should be 1.6mm below the base of the filter.
- Area directly under the filter should be free from copper.
- RF shield should be kept a minimum of 6mm above the filter.
- Recommended stack up as follows:

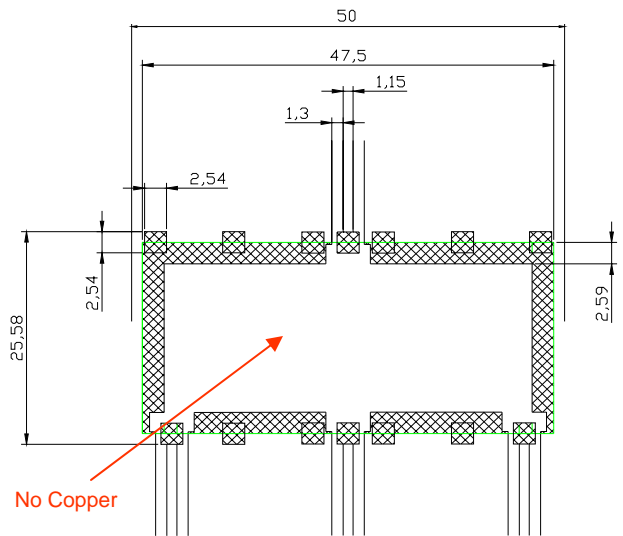
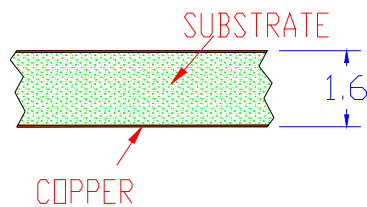

* Dimensions are millimeters ± 0.1 unless otherwise specified.

Typical Performance Curves

Common port Return Loss:

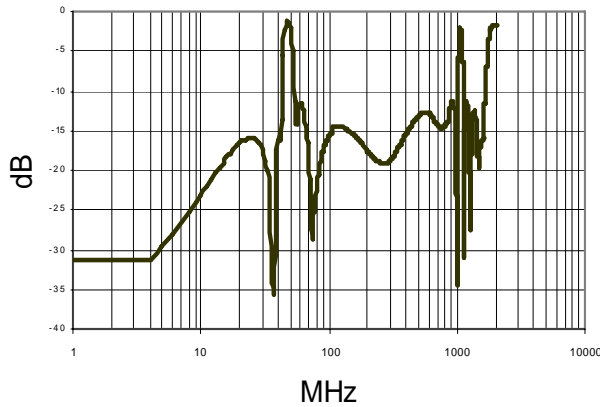

Common to Reverse Path filter performance:

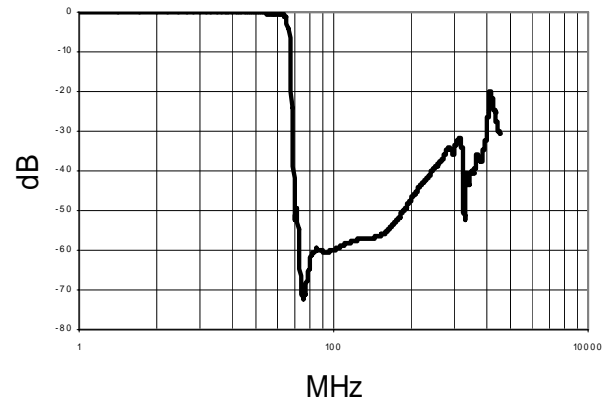

Common to Forward Path filter performance

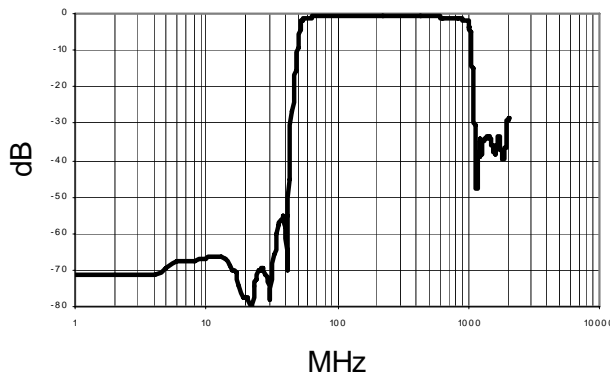

Common to MoCA Path filter performance

