

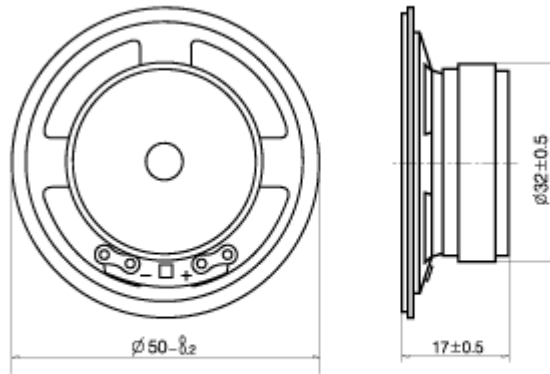

Type	BLS50-1B
Rated Impedance(Ω)	25 \pm 15%
Rated(Max.) Power(W)	0.2(0.4)
Resonant Frequency(Hz)	550 \pm 20%
Rated Freq.Range(Hz)	f ₀ ~4500
Sound Pressure Level(dB)	84 \pm 2
Magnet(g)	16.6
Operating Temperature($^{\circ}$ C)	-10~+40



Unit:mm

