



PTFA071701E
PTFA071701F
green
 Product

Thermally-Enhanced High Power RF LDMOS FETs 170 W, 725 – 770 MHz

Description

The PTFA071701E and PTFA071701F are 170-watt, LDMOS FETs designed for use in cellular power amplifiers in the 725 to 770 MHz frequency band. Features include internal I/O matching, and thermally-enhanced, ceramic open-cavity packages. Manufactured with Infineon's advanced LDMOS process, these devices provide excellent thermal performance and superior reliability.

PTFA071701E
 Package H-36248-2



PTFA071701F
 Package H-37248-2

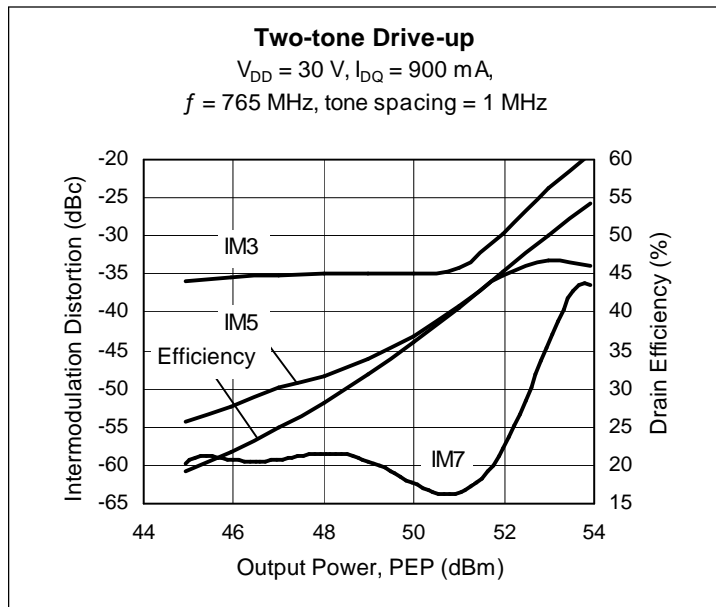

Features

- Thermally-enhanced packages, Pb-free and RoHS-compliant
- Broadband internal matching
- Typical CDMA2000 performance at 770 MHz, 30 V
 - Average output power = 35 W
 - Linear Gain = 18 dB
 - Efficiency = 34%
 - Adjacent channel power = -50 dBc
- Typical CW performance, 770 MHz, 30 V
 - Output power at P-1dB = 165 W
 - Efficiency = 62%
- Integrated ESD protection: Human Body Model, Class 2 (minimum)
- Excellent thermal stability, low HCI drift
- Capable of handling 10:1 VSWR @ 30 V, 170 W (CW) output power

RF Characteristics

Two-carrier WCDMA Measurements (not subject to production test—verified by design/characterization in Infineon test fixture)

$V_{DD} = 30\text{ V}$, $I_{DQ} = 1.0\text{ A}$, $P_{OUT} = 40\text{ W}$ average,

$f_1 = 760$, $f_2 = 770\text{ MHz}$, 3GPP signal, channel bandwidth = 3.84 MHz, peak/average = 8.1 dB at 0.01% CCDF

Characteristic	Symbol	Min	Typ	Max	Unit
Gain	G_{ps}	—	18.5	—	dB
Drain Efficiency	η_D	—	32	—	%
Adjacent Channel Power Ratio	ACPR	—	-36	—	dBc

All published data at $T_{CASE} = 25^\circ\text{C}$ unless otherwise indicated

ESD: Electrostatic discharge sensitive device—observe handling precautions!

RF Characteristics (cont.)

Two-tone Measurements (tested in Infineon test fixture)

$V_{DD} = 30\text{ V}$, $I_{DQ} = 0.9\text{ A}$, $P_{OUT} = 150\text{ W PEP}$, $f = 765\text{ MHz}$, tone spacing = 1 MHz

Characteristic	Symbol	Min	Typ	Max	Unit
Gain	G_{ps}	18.0	18.7	—	dB
Drain Efficiency	η_D	44	46	—	%
Intermodulation Distortion	IMD	—	-29.5	-28	dBc

DC Characteristics

Characteristic	Conditions	Symbol	Min	Typ	Max	Unit
Drain-Source Breakdown Voltage	$V_{GS} = 0\text{ V}$, $I_{DS} = 10\text{ mA}$	$V_{(BR)DSS}$	65	—	—	V
Drain Leakage Current	$V_{DS} = 30\text{ V}$, $V_{GS} = 0\text{ V}$	I_{DSS}	—	—	1.0	μA
	$V_{DS} = 63\text{ V}$, $V_{GS} = 0\text{ V}$	I_{DSS}	—	—	10.0	μA
On-State Resistance	$V_{GS} = 10\text{ V}$, $V_{DS} = 0.1\text{ V}$	$R_{DS(on)}$	—	0.07	—	Ω
Operating Gate Voltage	$V_{DS} = 30\text{ V}$, $I_{DQ} = 1.0\text{ A}$	V_{GS}	2.0	2.48	3.0	V
Gate Leakage Current	$V_{GS} = 10\text{ V}$, $V_{DS} = 0\text{ V}$	I_{GSS}	—	—	1.0	μA

Maximum Ratings

Parameter	Symbol	Value	Unit
Drain-Source Voltage	V_{DSS}	65	V
Gate-Source Voltage	V_{GS}	-0.5 to +12	V
Junction Temperature	T_J	200	$^{\circ}\text{C}$
Storage Temperature Range	T_{STG}	-40 to +150	$^{\circ}\text{C}$
Thermal Resistance ($T_{CASE} = 70^{\circ}\text{C}$, 170 W CW)	$R_{\theta JC}$	0.38	$^{\circ}\text{C/W}$

Ordering Information

Type and Version	Package Type	Package Description	Shipping
PTFA071701E V4	H-36248-2	Slotted flange, single-ended	Tray
PTFA071701E V4 R250	H-36248-2	Slotted flange, single-ended	Tape & Reel 250 pcs
PTFA071701F V4	H-37248-2	Earless flange, single-ended	Tray
PTFA071701F V4 R250	H-37248-2	Earless flange, single-ended	Tape & Reel 250 pcs

Typical Performance (data taken in a production test fixture)

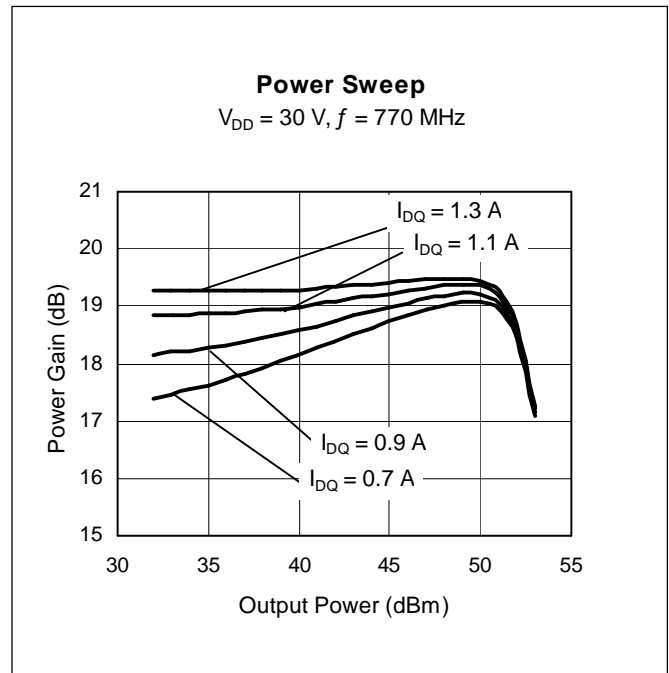
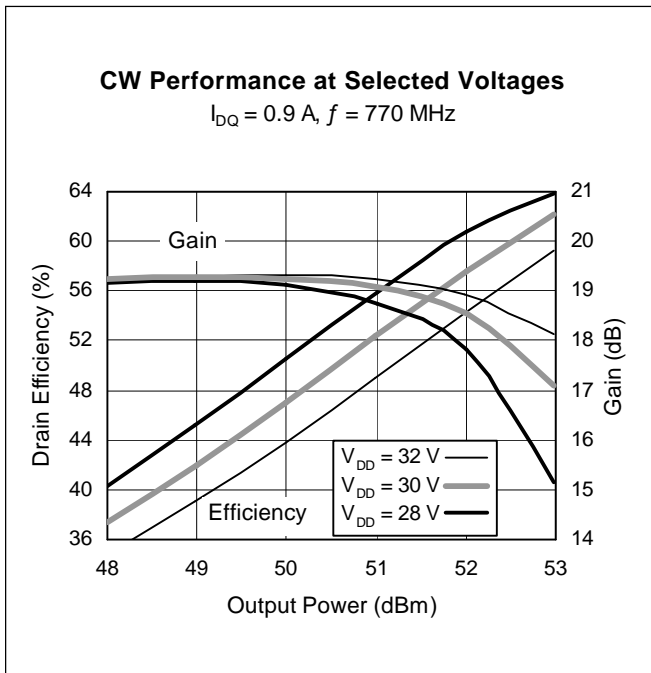
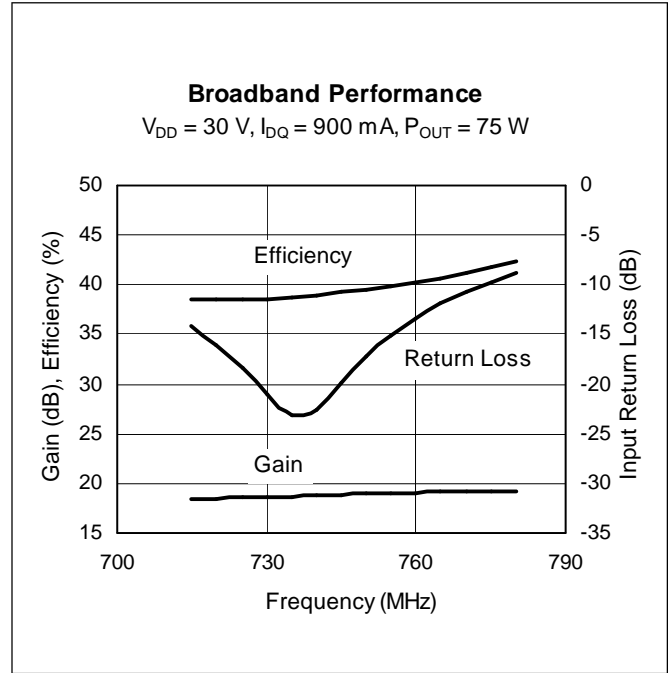
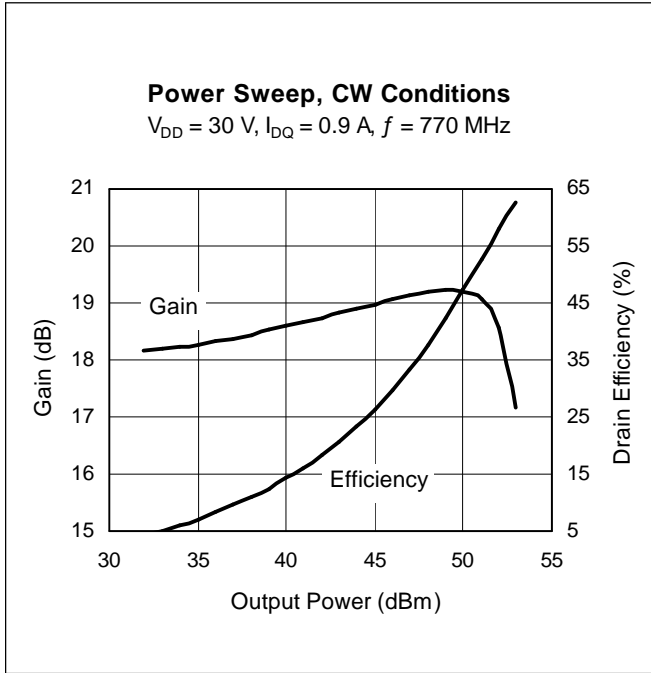

Typical Performance (cont.)

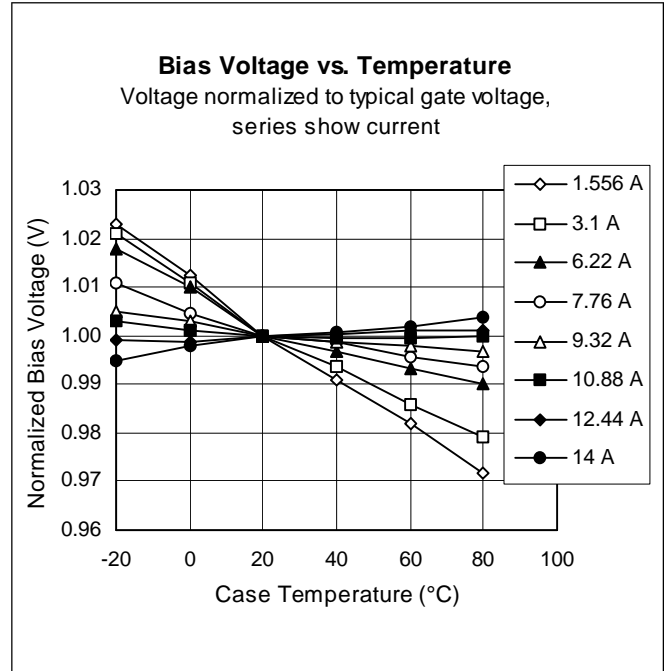
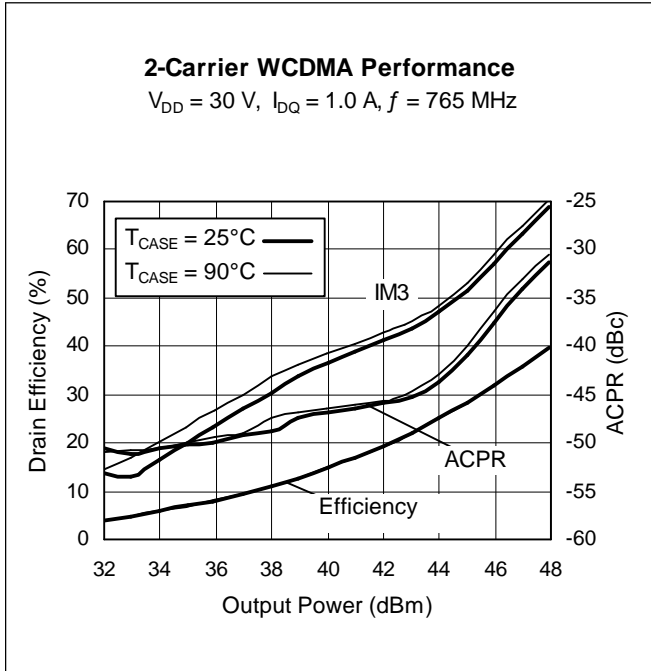

Broadband Circuit Impedance

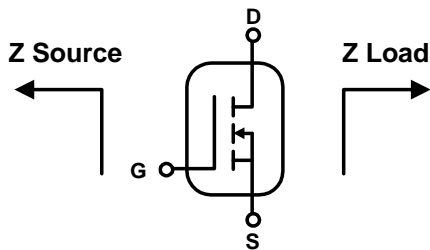

Frequency MHz	Z Source W		Z Load W	
	R	jX	R	jX
725	2.690	-3.730	2.070	-1.27
736	2.680	-3.470	2.020	-1.08
748	2.700	-3.240	1.980	-0.84
759	2.720	-3.050	1.930	-0.64
770	2.690	-2.890	1.900	-0.46

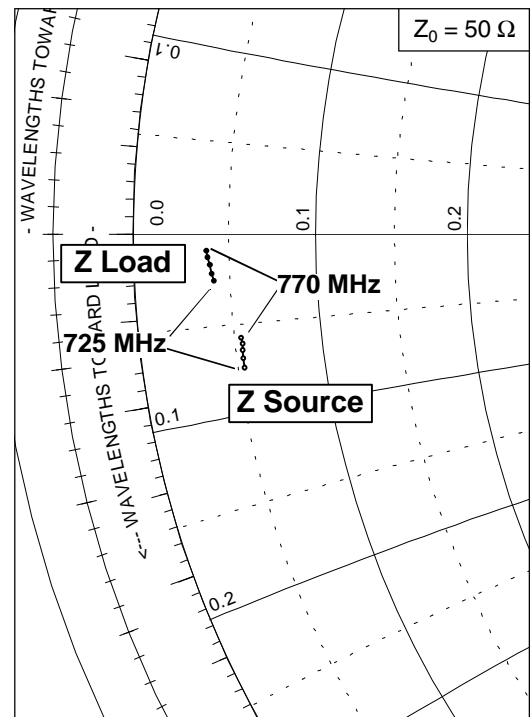

Reference Circuit

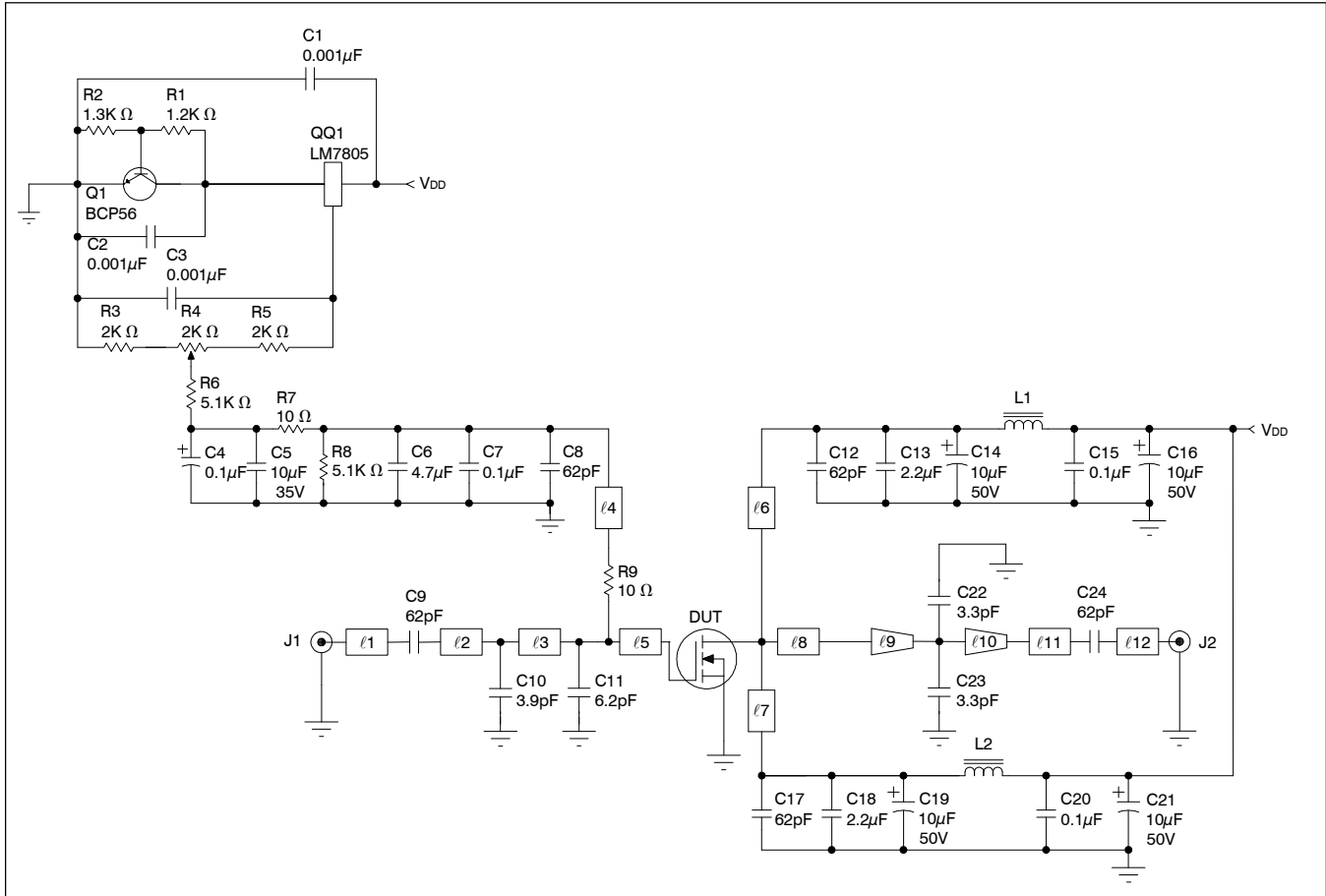

Reference circuit schematic for $f = 770 \text{ MHz}$

Circuit Assembly Information

DUT	PTFA071701E or PTFA071701F	LDMOS Transistor	
PCB	0.76 mm [.030"] thick, $\epsilon_r = 3.48$	Rogers RO4350	1 oz. copper

Microstrip	Electrical Characteristics at 770 MHz	Dimensions: L x W (mm)	Dimensions: L x W (in.)
$\ell 1$	0.025λ , 50.7Ω	5.84 x 1.65	0.230 x 0.065
$\ell 2$	0.053λ , 38.4Ω	12.32 x 2.54	0.485 x 0.100
$\ell 3$	0.035λ , 38.4Ω	8.00 x 2.54	0.315 x 0.100
$\ell 4$	0.148λ , 76.7Ω	35.94 x 0.76	1.415 x 0.030
$\ell 5$	0.094λ , 7.8Ω	20.32 x 17.78	0.800 x 0.700
$\ell 6, \ell 7$	0.103λ , 44.5Ω	24.13 x 2.03	0.950 x 0.080
$\ell 8$	0.139λ , 8.4Ω	29.97 x 16.51	1.180 x 0.650
$\ell 9$ (taper)	0.062λ , $8.4 \Omega / 33.8 \Omega$	13.46 x 16.51 / 3.05	0.530 x 0.650 / 0.120
$\ell 10$ (taper)	0.002λ , $33.8 \Omega / 38.4 \Omega$	0.51 x 3.05 / 2.54	0.020 x 0.120 / 0.100
$\ell 11$	0.005λ , 38.4Ω	1.27 x 2.54	0.050 x 0.100
$\ell 12$	0.016λ , 50.7Ω	3.76 x 1.65	0.148 x 0.065

Reference Circuit (cont.)

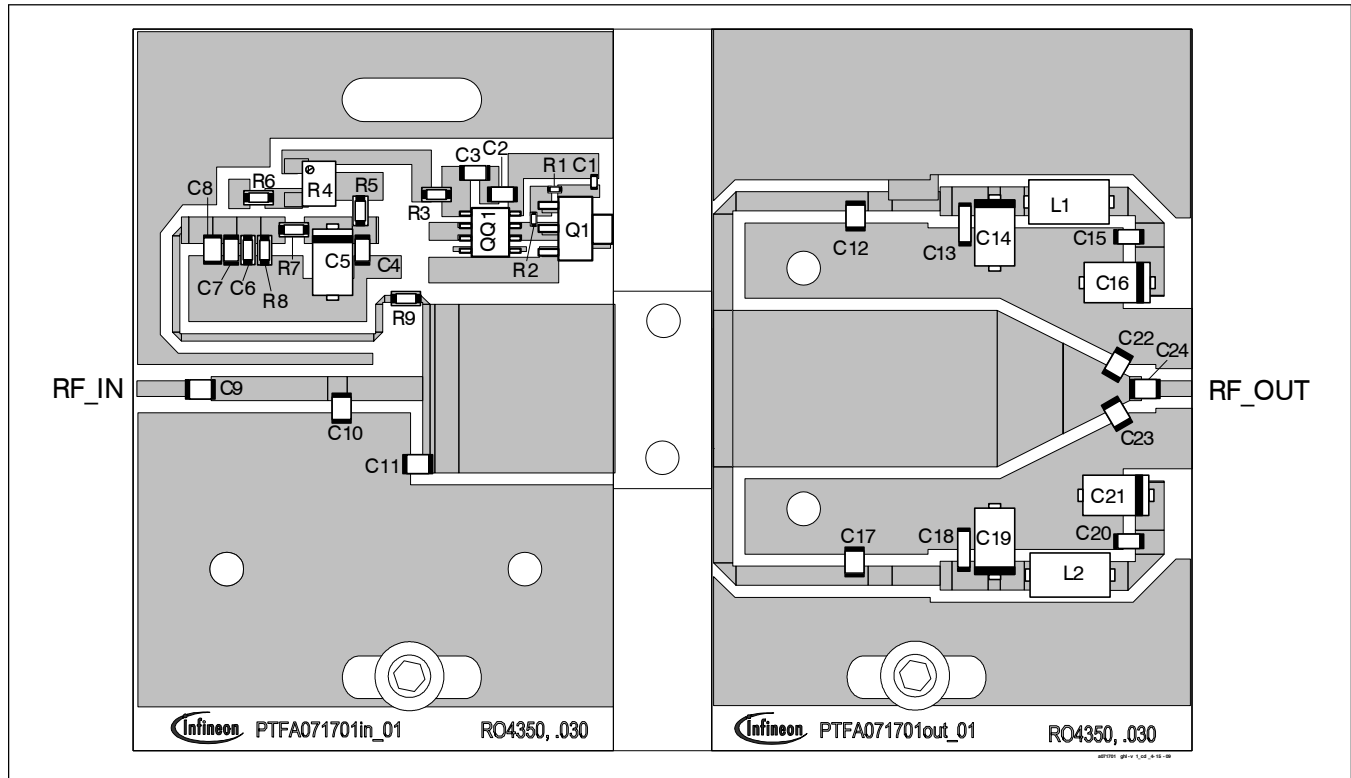

Reference circuit assembly diagram* (not to scale)

Component	Description	Suggested Manufacturer	P/N or Comment
C1, C2, C3	Capacitor, 0.001 μF	Digi-Key	PCC1772CT-ND
C4, C7, C15, C20	Capacitor, 0.1 μF	Digi-Key	PCC104BCT-ND
C6	Capacitor, 4.7 μF , 16 V	Digi-Key	PCS3475CT-ND
C5	Tantalum capacitor, 10 μF , 35 V	Digi-Key	399-1655-2-ND
C8, C9, C12, C17, C24	Ceramic capacitor, 62 pF	ATC	100B 620
C10	Ceramic capacitor, 3.9 pF	ATC	100B 3R9
C11	Ceramic capacitor, 6.2 pF	ATC	100B 7R5
C13, C18	Capacitor, 2.2 μF	ATC	920C 202
C14, C16, C19, C21	Tantalum capacitor, 10 μF , 50 V	Garrett Electronics	TPSE106K050R0400
C22, C23	Ceramic capacitor, 3.3 pF	ATC	100B 3R3
L1, L2	Ferrite, 8.9 mm	Elna Magnetics	BDS 4.6/3/8.9-4S2
Q1	Transistor	Infineon Technologies	BCP56
QQ1	Voltage regulator	National Semiconductor	LM7805
R1	Chip resistor, 1.2k Ω	Digi-Key	P1.2KGCT-ND
R2	Chip resistor, 1.3k Ω	Digi-Key	P1.3KGCT-ND
R3, R5	Chip resistor, 2k Ω	Digi-Key	P2KECT-ND
R4	Potentiometer, 2k Ω	Digi-Key	3224W-202ETR-ND
R6, R8	Chip resistor, 5.1k Ω	Digi-Key	P5.1KECT-ND
R7, R9	Chip resistor, 10 Ω	Digi-Key	P10ECT-ND

*Gerber files for this circuit available on request

Package Outline Specifications

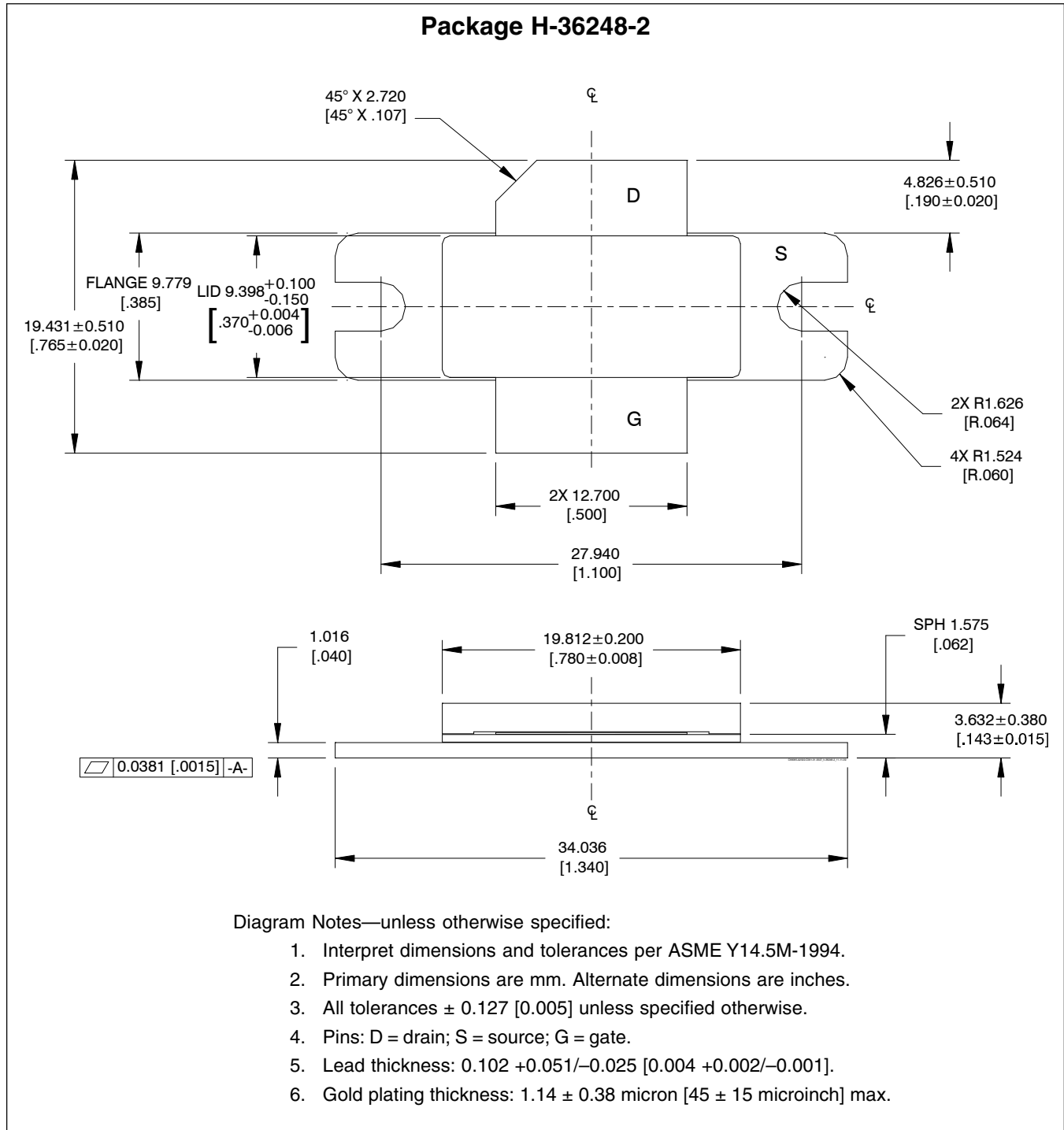

Package Outline Specifications (cont.)

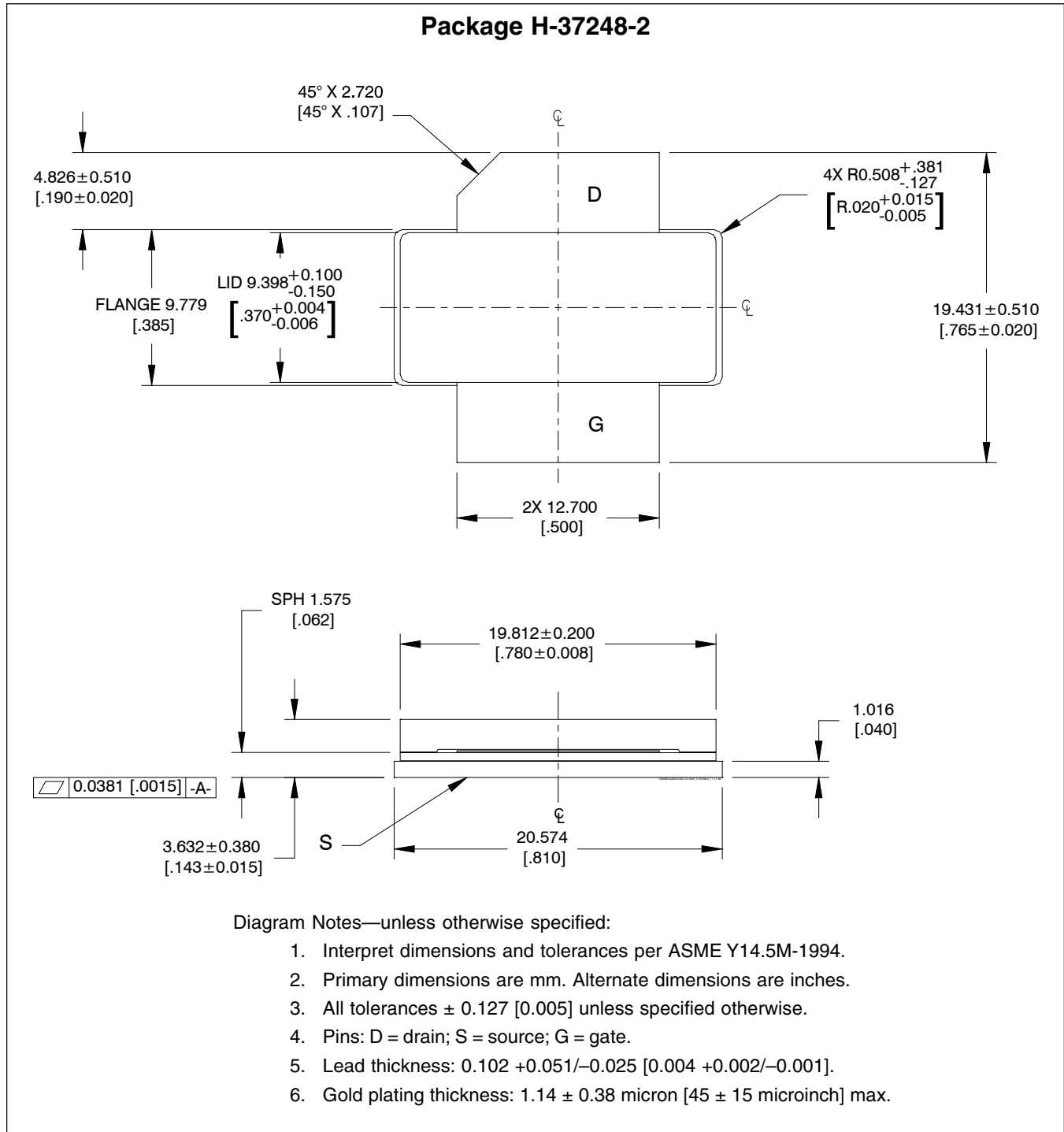

Find the latest and most complete information about products and packaging at the Infineon Internet page
<http://www.infineon.com/rfpower>