

Thermally-Enhanced High Power RF LDMOS FET 10 W, 2400 – 2700 MHz

Description

The PTF240101S is a 10-watt, internally-matched *GOLDMOS*® FET device intended for CDMA2000 and WiMAX applications in the 2.4 to 2.7 GHz band. Full gold metallization ensures excellent device lifetime and reliability.

PTF240101S
Package H-32259-2

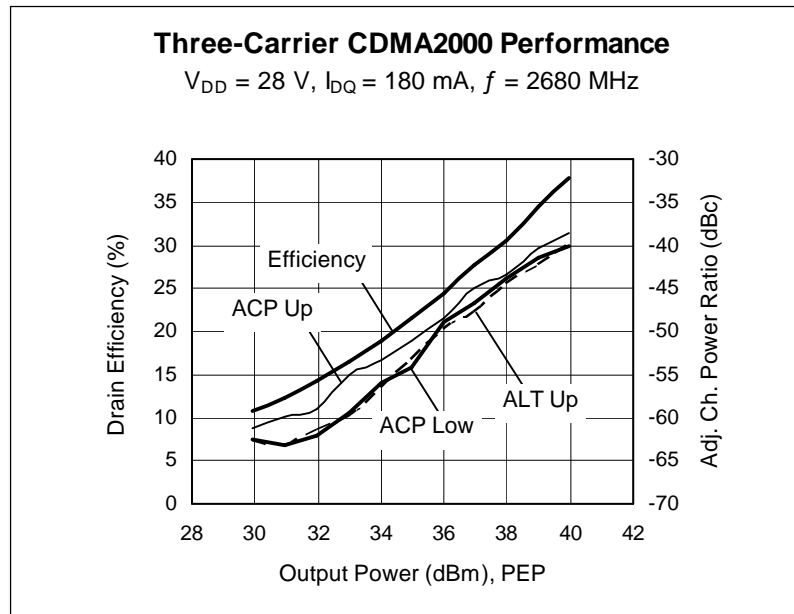

Features

- Pb-free and RoHS-compliant
- Typical CDMA2000 performance
 - Average output power = 2.0 W
 - Gain = 16 dB
 - Efficiency = 18%
 - ACPR = -55 dBc
- Typical CW performance
 - Output power at P-1dB = 15 W
 - Efficiency = 45%
- Integrated ESD protection: Human Body Model Class 1 (minimum)
- Excellent thermal stability
- Low HCI drift
- Capable of handling 10:1 VSWR @ 28 V, 10 W (CW) output power

RF Characteristics, CDMA2000 Operation

CDMA2000 Measurements (not subject to production test—verified by design/characterization in Infineon test fixture)

$V_{DD} = 28\text{ V}$, $I_{DQ} = 180\text{ mA}$, $P_{OUT} = 2\text{ W}$, $f = 2680\text{ MHz}$

Characteristic	Symbol	Min	Typ	Max	Unit
Adjacent Channel Power Ratio	ACPR	—	-55	—	dBc
Gain	G_{ps}	—	16	—	dB

Two-tone Measurements (tested in Infineon test fixture)

$V_{DD} = 28\text{ V}$, $I_{DQ} = 180\text{ mA}$, $P_{OUT} = 10\text{ W PEP}$, $f = 2680\text{ MHz}$, tone spacing = 1 MHz

Characteristic	Symbol	Min	Typ	Max	Unit
Gain	G_{ps}	15.5	16	—	dB
Intermodulation Distortion	IMD	—	-31	-28	dBc

All published data at $T_{CASE} = 25^\circ\text{C}$ unless otherwise indicated

ESD: Electrostatic discharge sensitive device—observe handling precautions!

RF Characteristics (cont.)

Two-tone Measurements (tested in Infineon test fixture) (cont.)

 $V_{DD} = 28\text{ V}$, $I_{DQ} = 160\text{ mA}$, $f = 2680\text{ MHz}$, tone spacing = 7 MHz

Characteristic	Symbol	Min	Typ	Max	Unit
Gain	G_{ps}	14	15	—	dB
Efficiency at 1 W avg.	η_D	9	10	—	%
Intermodulation Distortion at 1 W avg.	IMD	—	-42	-40	dBc
Compression at 10 W avg.	P_{comp}	—	0.3	1.0	dB
Input Return Loss at 2.4 GHz	IRL	-10	-12	—	dB

DC Characteristics

Characteristic	Conditions	Symbol	Min	Typ	Max	Unit
Drain-Source Breakdown Voltage	$V_{GS} = 0\text{ V}$, $I_{DS} = 10\text{ }\mu\text{A}$	$V_{(BR)DSS}$	65	—	—	V
Drain Leakage Current	$V_{DS} = 28\text{ V}$, $V_{GS} = 0\text{ V}$	I_{DSS}	—	—	1.0	μA
On-State Resistance	$V_{GS} = 10\text{ V}$, $V_{DS} = 0.1\text{ A}$	$R_{DS(on)}$	—	0.83	—	Ω
Operating Gate Voltage	$V_{DS} = 28\text{ V}$, $I_{DQ} = 180\text{ mA}$	V_{GS}	2.5	3.2	4.0	V
Gate Leakage Current	$V_{GS} = 10\text{ V}$, $V_{DS} = 0\text{ V}$	I_{GSS}	—	—	1.0	μA

Maximum Ratings

Parameter	Symbol	Value	Unit
Drain-Source Voltage	V_{DSS}	65	V
Gate-Source Voltage	V_{GS}	-0.5 to +12	V
Junction Temperature	T_J	200	$^{\circ}\text{C}$
Total Device Dissipation	P_D	58	W
Above 25 $^{\circ}\text{C}$ derate by		0.333	W/ $^{\circ}\text{C}$
Storage Temperature Range	T_{STG}	-40 to +150	$^{\circ}\text{C}$
Thermal Resistance ($T_{CASE} = 70^{\circ}\text{C}$, 10 W CW)	$R_{\theta JC}$	3.0	$^{\circ}\text{C}/\text{W}$

Ordering Information

Type	Package Outline	Package Description	Marking
PTF240101S	H-32259-2	Thermally-enhanced, surface mount	PTF240101S

Typical Performance, CDMA2000 Operation (measurements taken in broadband test fixture)

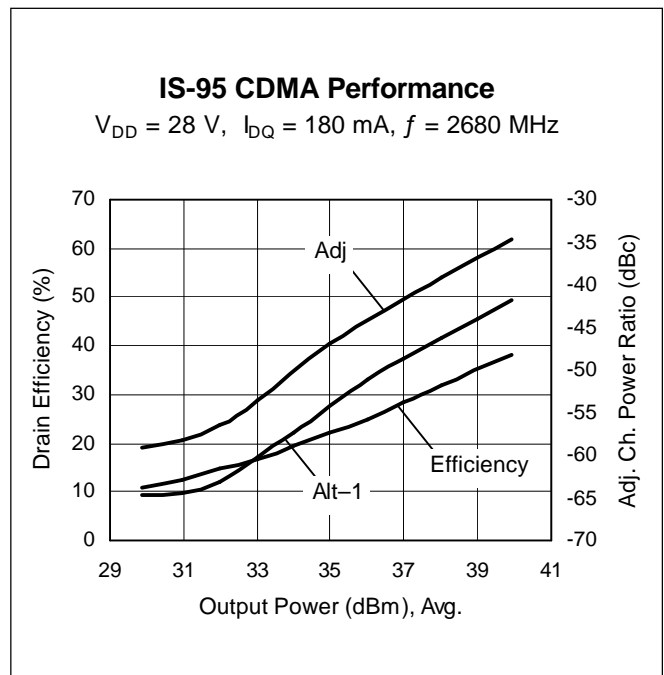
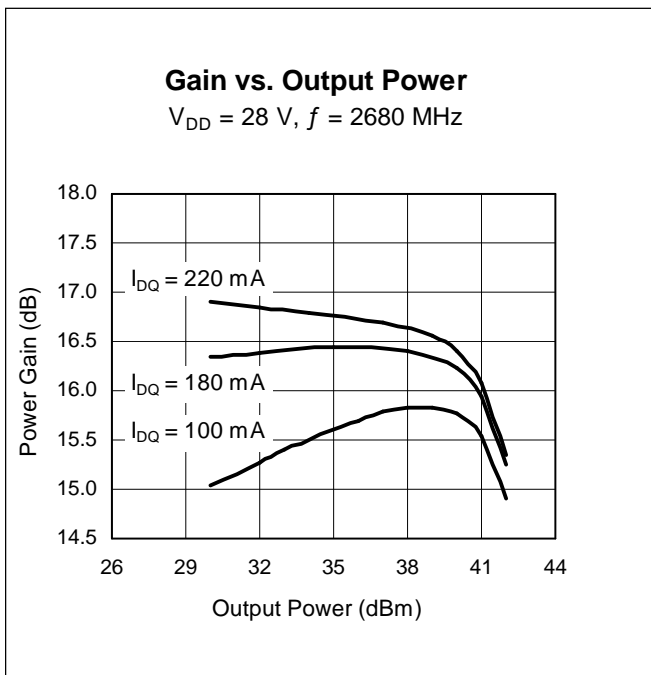
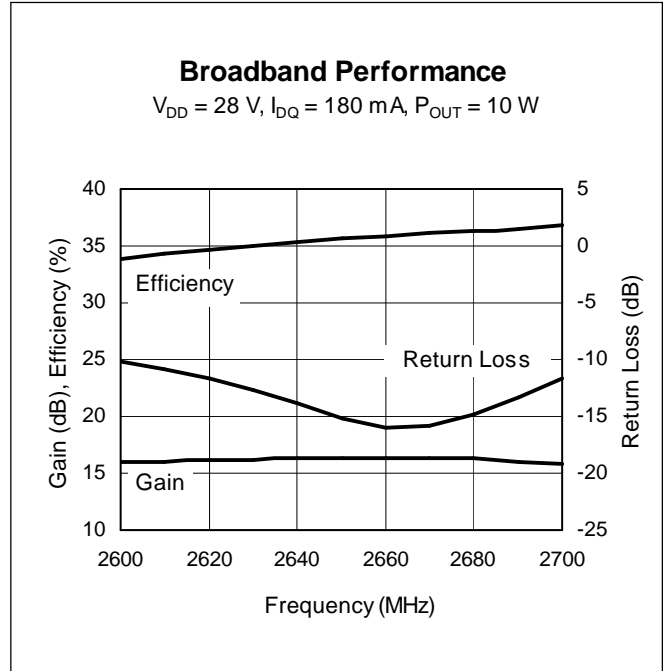
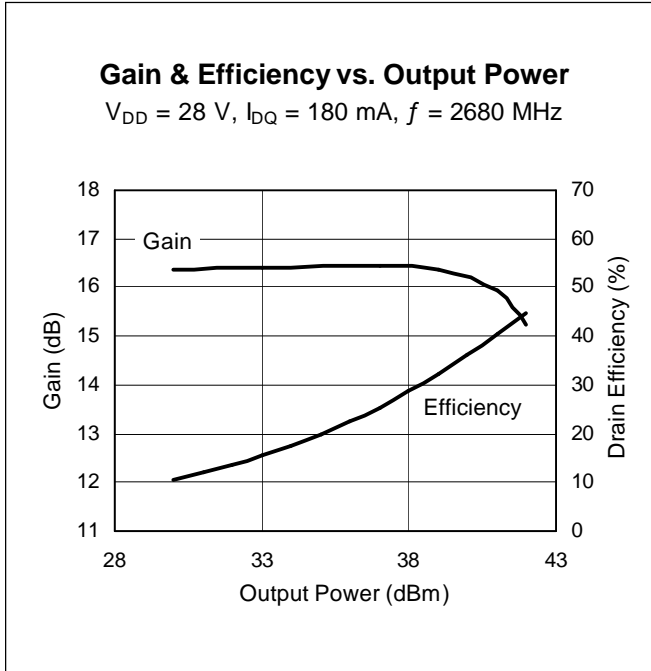

Typical Performance (cont.)

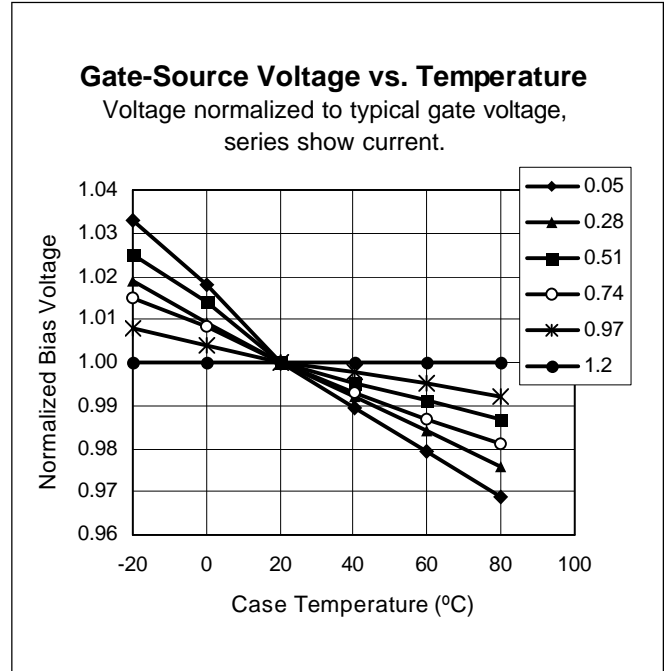
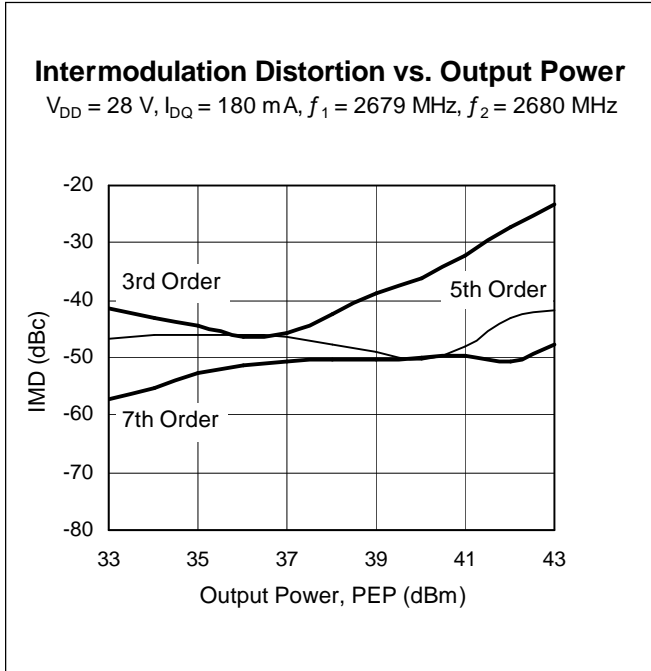

Broadband Circuit Impedance Data

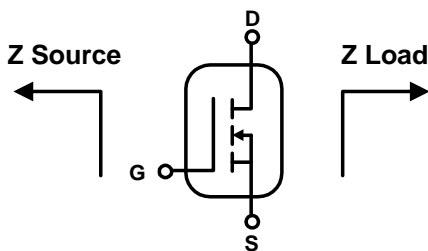

Frequency MHz	Z Source W		Z Load W	
	R	jX	R	jX
2400	3.8	-13.5	4.7	-3.6
2450	3.4	-12.7	4.3	-3.3
2500	3.1	-10.5	4.0	-2.8
2550	3.3	-10.0	3.6	-2.4
2600	2.6	-8.3	3.4	-1.9
2650	2.9	-7.4	3.2	-1.4
2700	2.5	-6.0	3.1	-1.0

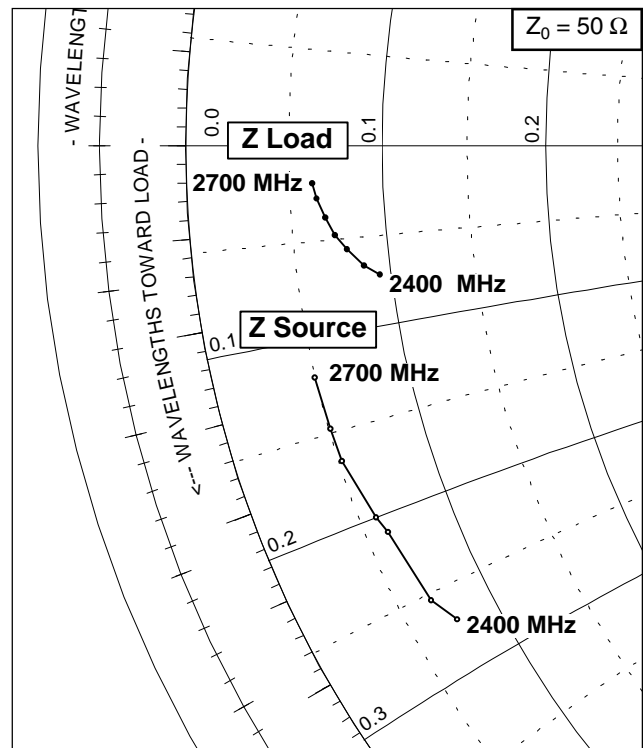

CDMA2000 Reference Circuit

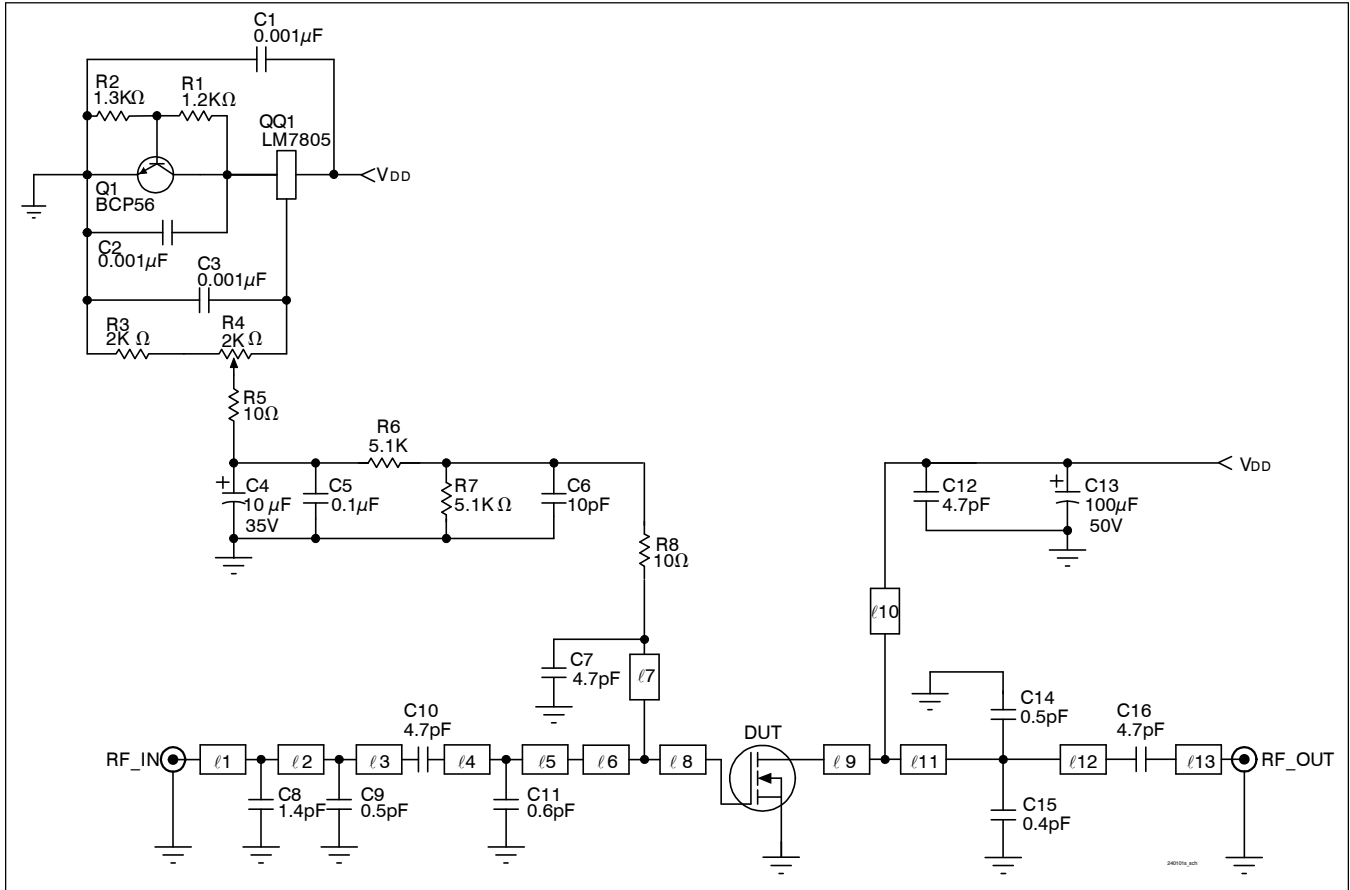

Reference Circuit Schematic for $f = 2650 \text{ MHz}$

Circuit Assembly Information

DUT	PTF240101S	LDMOS Transistor	
Circuit Board	0.76 mm [0.030"] thick, $\epsilon_r = 4.5$	Rogers TMM4, 2 oz. Copper	

Microstrip	Electrical Characteristics at 2650 MHz	Dimensions: L x W (mm)	Dimensions: L x W (in.)
$\ell 1$	0.043 λ , 50.0 Ω	2.67 x 1.35	0.105 x 0.053
$\ell 2$	0.119 λ , 50.0 Ω	7.37 x 1.35	0.290 x 0.053
$\ell 3$	0.173 λ , 50.0 Ω	10.67 x 1.35	0.420 x 0.053
$\ell 4$	0.114 λ , 50.0 Ω	7.06 x 1.35	0.278 x 0.053
$\ell 5$	0.030 λ , 50.0 Ω	1.83 x 1.35	0.072 x 0.053
$\ell 6$	0.019 λ , 13.3 Ω	1.09 x 8.81	0.043 x 0.347
$\ell 7$	0.278 λ , 75.0 Ω	17.60 x 0.69	0.693 x 0.027
$\ell 8$	0.038 λ , 13.3 Ω	2.18 x 8.81	0.086 x 0.347
$\ell 9$	0.027 λ , 13.3 Ω	1.52 x 8.81	0.060 x 0.347
$\ell 10$	0.327 λ , 75.0 Ω	20.73 x 0.69	0.816 x 0.027
$\ell 11$	0.086 λ , 13.3 Ω	4.83 x 8.81	0.190 x 0.347
$\ell 12$	0.177 λ , 50.0 Ω	10.92 x 1.35	0.430 x 0.053
$\ell 13$	0.217 λ , 50.0 Ω	13.41 x 1.35	0.528 x 0.053

CDMA2000 Reference Circuit (cont.)

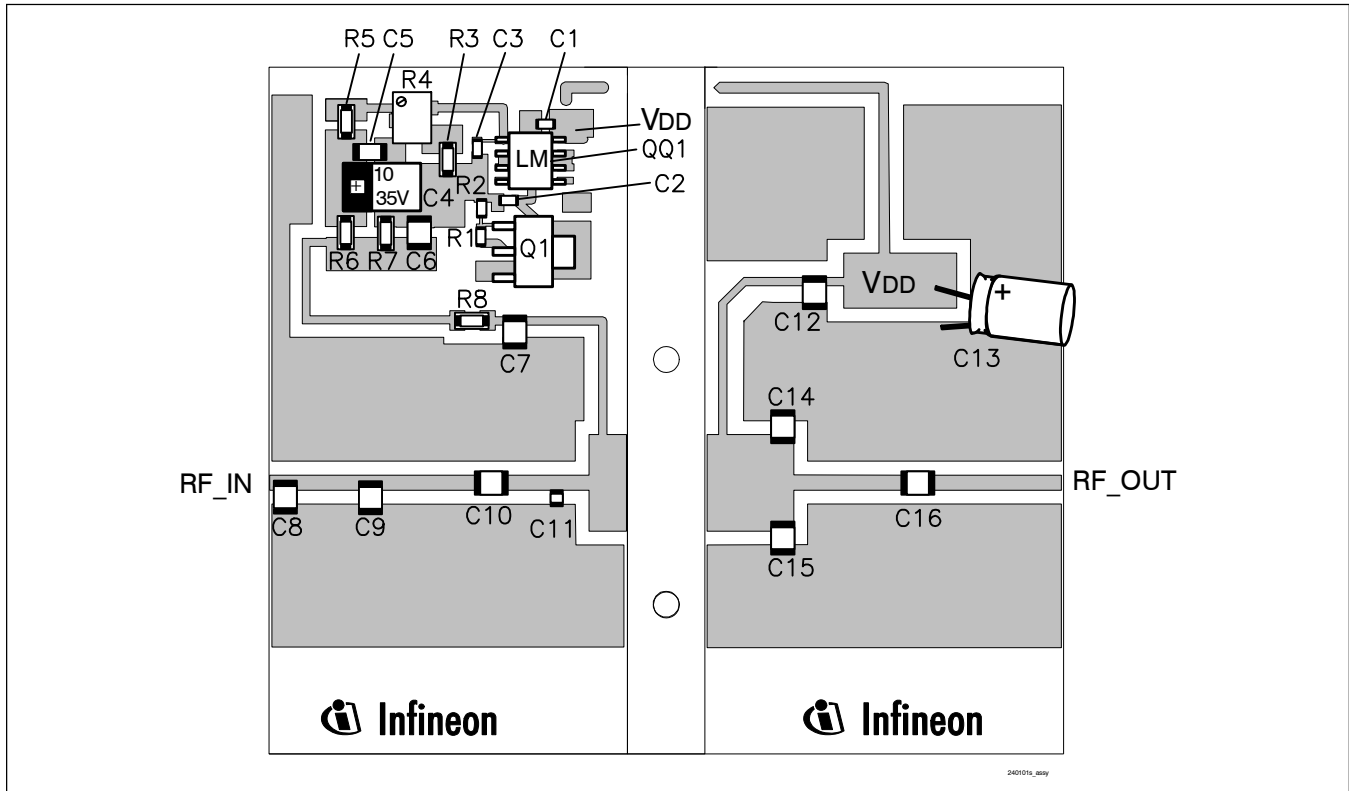

Reference circuit assembly diagram (not to scale)*

Component	Description	Suggested Manufacturer	P/N or Comment
C1, C2, C3	Capacitor, 0.001 μ F	Digi-Key	PCC1772CT-ND
C4	Tantalum capacitor, 10 μ F, 35 V	Digi-Key	PCS6106TR-ND
C5	Capacitor, 0.1 μ F	Digi-Key	PCC104BCT-ND
C6	Ceramic capacitor, 10 pF	ATC	100B 100
C7, C10, C12, C16	Ceramic capacitor, 4.7 pF	ATC	100B 4R7
C8	Ceramic capacitor, 1.4 pF	ATC	100B 1R4
C9, C14	Ceramic capacitor, 0.5 pF	ATC	100B 0R5
C11	Ceramic capacitor, 0.6 pF	ATC	100A 0R6
C13	Tantalum capacitor, 100 μ F, 50 V	Digi-Key	P5571-ND
C15	Ceramic capacitor, 0.4 pF	ATC	100B 0R4
Q1	Transistor	Infineon	BCP56
QQ1	Voltage Regulator	National Semiconductor	LM7805
R1	Chip resistor, 1.2 k-ohms	Digi-Key	P1.2KGCT-ND
R2	Chip resistor, 1.3 k-ohms	Digi-Key	P1.3KGCT-ND
R3	Chip resistor, 2 k-ohms	Digi-Key	P2KECT-ND
R4	Potentiometer, 2 k-ohms	Digi-Key	3224W-202ETR-ND
R5, R8	Chip resistor, 10 ohms	Digi-Key	P10ECT-ND
R6, R7	Chip resistor, 5.1 k-ohms	Digi-Key	P5.1KECT-ND

*Gerber files for this circuit are available upon request.

RF Characteristics, WiMAX Operation

WiMAX Measurements (not subject to production test—verified by design/characterization in Infineon test fixture)

$V_{DD} = 28\text{ V}$, $I_{DQ} = 160\text{ mA}$, $P_{OUT} = 1\text{ W}$, $f = 2400\text{ MHz}$, 3.5 MHz bandwidth, 4 MHz sampling rate, 64 QAM 2/3

Characteristic	Symbol	Min	Typ	Max	Unit
Error Vector Magnitude	EVM	—	-41	—	dBc
Gain	G_{ps}	—	15.5	—	dB

Two-tone Measurements (tested in Infineon test fixture)

$V_{DD} = 28\text{ V}$, $I_{DQ} = 160\text{ mA}$, $P_{OUT} = 1\text{ W avg.}$, $f = 2300, 2400, 2500\text{ MHz}$, tone spacing = 7 MHz

Characteristic	Symbol	Min	Typ	Max	Unit
Gain	G_{ps}	14.0	15.5	—	dB
Intermodulation Distortion	IMD	—	-43	-40	dBc
Drain Efficiency	η_D	9	10	—	%
Input Return Loss at 2.4 GHz	IRL	—	-14	-10	dB

Typical WiMAX Performance (measurements taken in broadband test fixture)

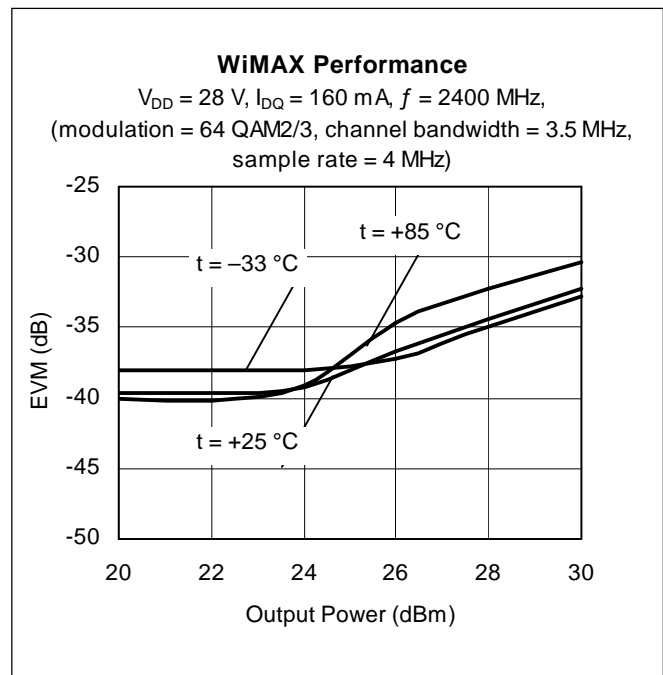
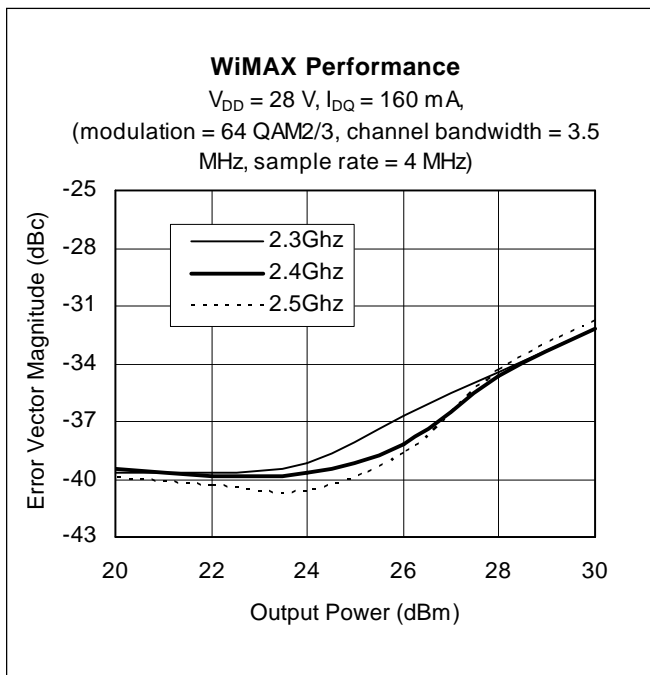

Typical WiMAX Performance (cont.)

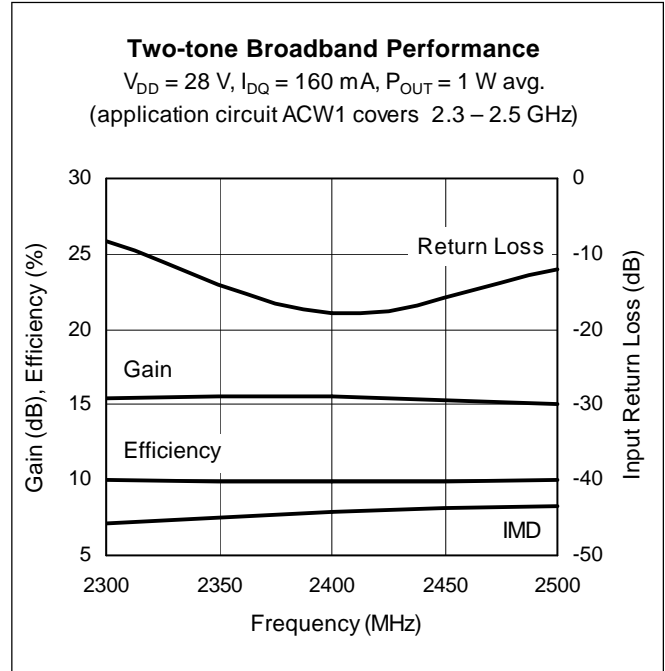
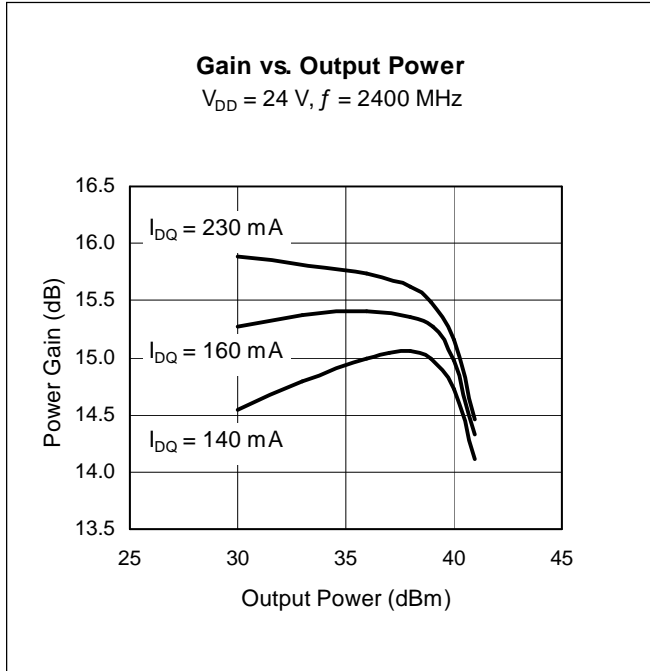

See next page for WiMAX circuit information

WiMAX Reference Circuit

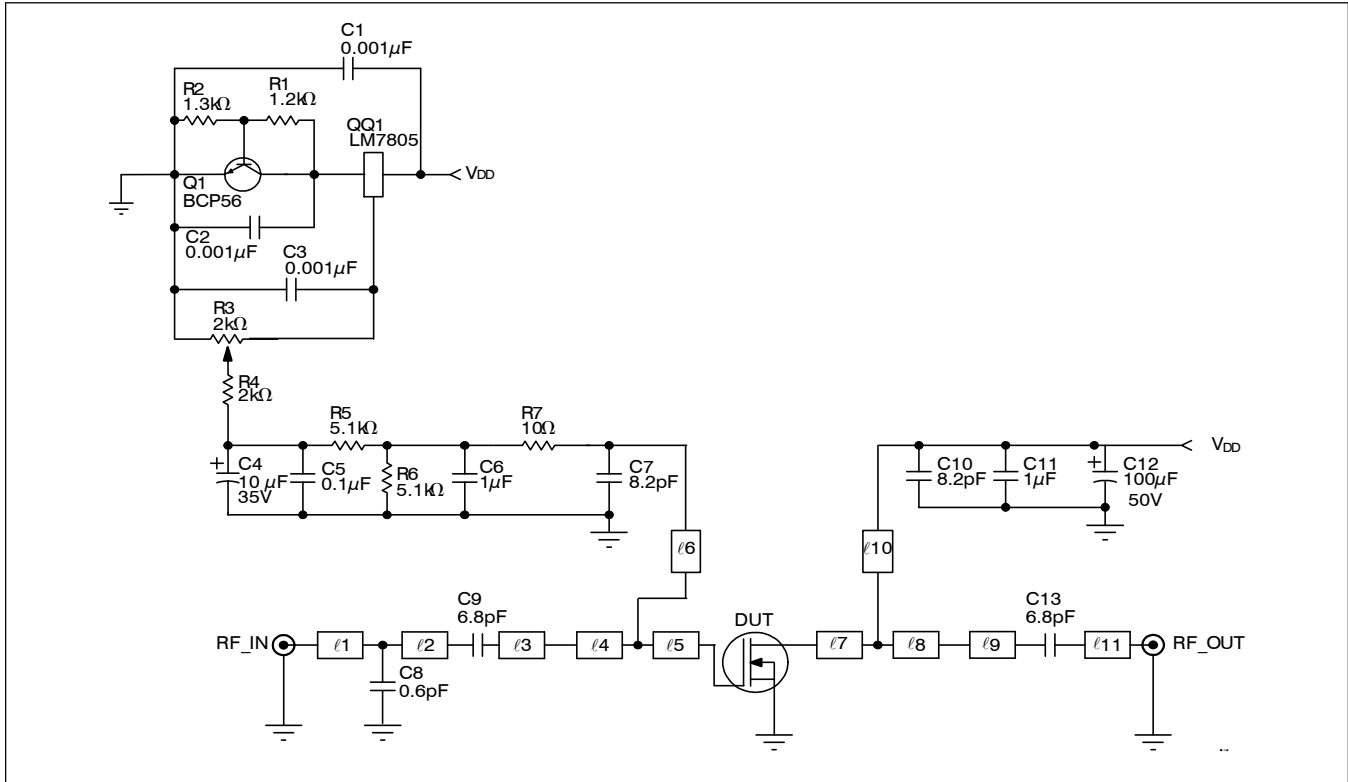

WiMAX reference circuit schematic $f = 2500 \text{ MHz}$

Circuit Assembly Information

DUT	PTF240101S	LDMOS Transistor	
Circuit Board	0.76 mm [0.030"] thick, $\epsilon_r = 4.5$	Rogers TMM4, 2 oz. Copper	

Microstrip	Electrical Characteristics at 2500 MHz ¹	Dimensions: L x W (mm)	Dimensions: L x W (in.)
ℓ1	0.036 λ , 50.0 Ω	5.28 x 1.37	0.208 x 0.054
ℓ2	0.081 λ , 50.0 Ω	13.69 x 1.37	0.539 x 0.054
ℓ3	0.105 λ , 38.0 Ω	6.71 x 2.16	0.264 x 0.085
ℓ4	0.051 λ , 8.8 Ω	3.00 x 13.64	0.118 x 0.537
ℓ5	0.035 λ , 8.8 Ω	2.03 x 13.64	0.080 x 0.537
ℓ6	0.278 λ , 75.0 Ω	17.60 x 0.69	0.693 x 0.027
ℓ7	0.025 λ , 12.9 Ω	1.50 x 8.89	0.059 x 0.350
ℓ8	0.147 λ , 12.9 Ω	8.71 x 8.89	0.343 x 0.350
ℓ9	0.323 λ , 68.0 Ω	21.59 x 0.76	0.850 x 0.030
ℓ10	0.133 λ , 33.0 Ω	8.38 x 2.74	0.330 x 0.108
ℓ11	0.183 λ , 50.0 Ω	11.91 x 1.37	0.469 x 0.054

¹ Electrical Characteristics are rounded

WiMAX Reference Circuit (cont.)

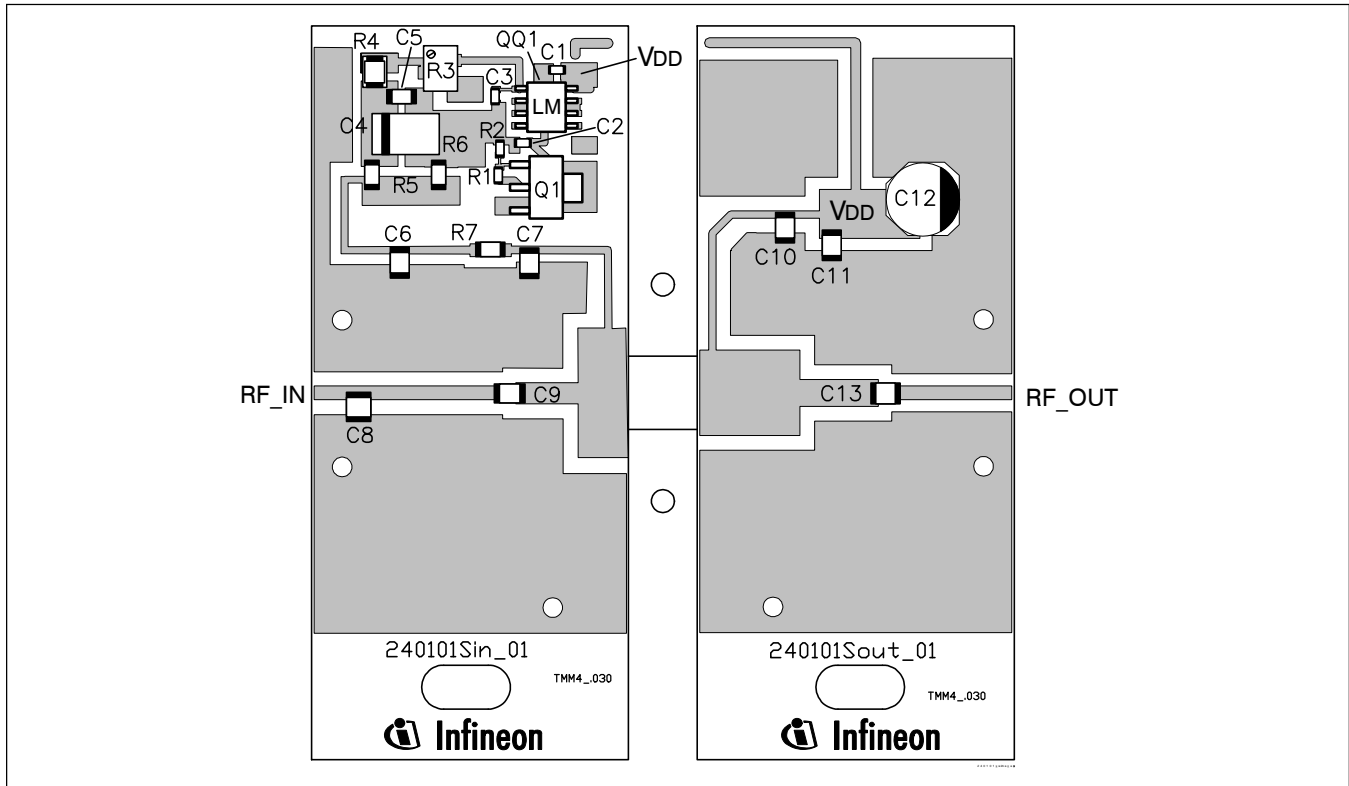

Reference circuit assembly diagram (not to scale)*

Component	Description	Suggested Manufacturer	P/N or Comment
C1, C2, C3	Capacitor, 0.001 μ F	Digi-Key	PCC1772CT-ND
C4	Tantalum capacitor, 10 μ F, 35 V	Digi-Key	PCS6106TR-ND
C5	Capacitor, 0.1 μ F	Digi-Key	PCC104BCT-ND
C6, C11	Ceramic capacitor, 0.01 μ F	Digi-Key	PCC103BCT-ND
C7, C10	Ceramic capacitor, 8.2 pF	ATC	100B 8R2
C8	Ceramic capacitor, 0.6 pF	ATC	100B 0R6
C9, C13	Ceramic capacitor, 6.8 pF	ATC	100B 6R8
C12	Tantalum capacitor, 100 μ F, 50 V	Digi-Key	P5571-ND
C15	Ceramic capacitor, 0.4 pF	ATC	100B 0R4
Q1	Transistor	Infineon	BCP56
QQ1	Voltage Regulator	National Semiconductor	LM7805
R1	Chip resistor, 1.2k ohms	Digi-Key	P1.2KGCT-ND
R2	Chip resistor, 1.3k ohms	Digi-Key	P1.3KGCT-ND
R3	Potentiometer, 2k ohms	Digi-Key	3224W-202ETR-ND
R4	Chip resistor, 2k ohms	Digi-Key	P2KECT-ND
R5, R6	Chip resistor, 5.1k ohms	Digi-Key	P5.1KECT-ND
R7	Chip resistor, 10 ohms	Digi-Key	P10ECT-ND

*Gerber files for this circuit are available upon request.

Package Outline Specifications

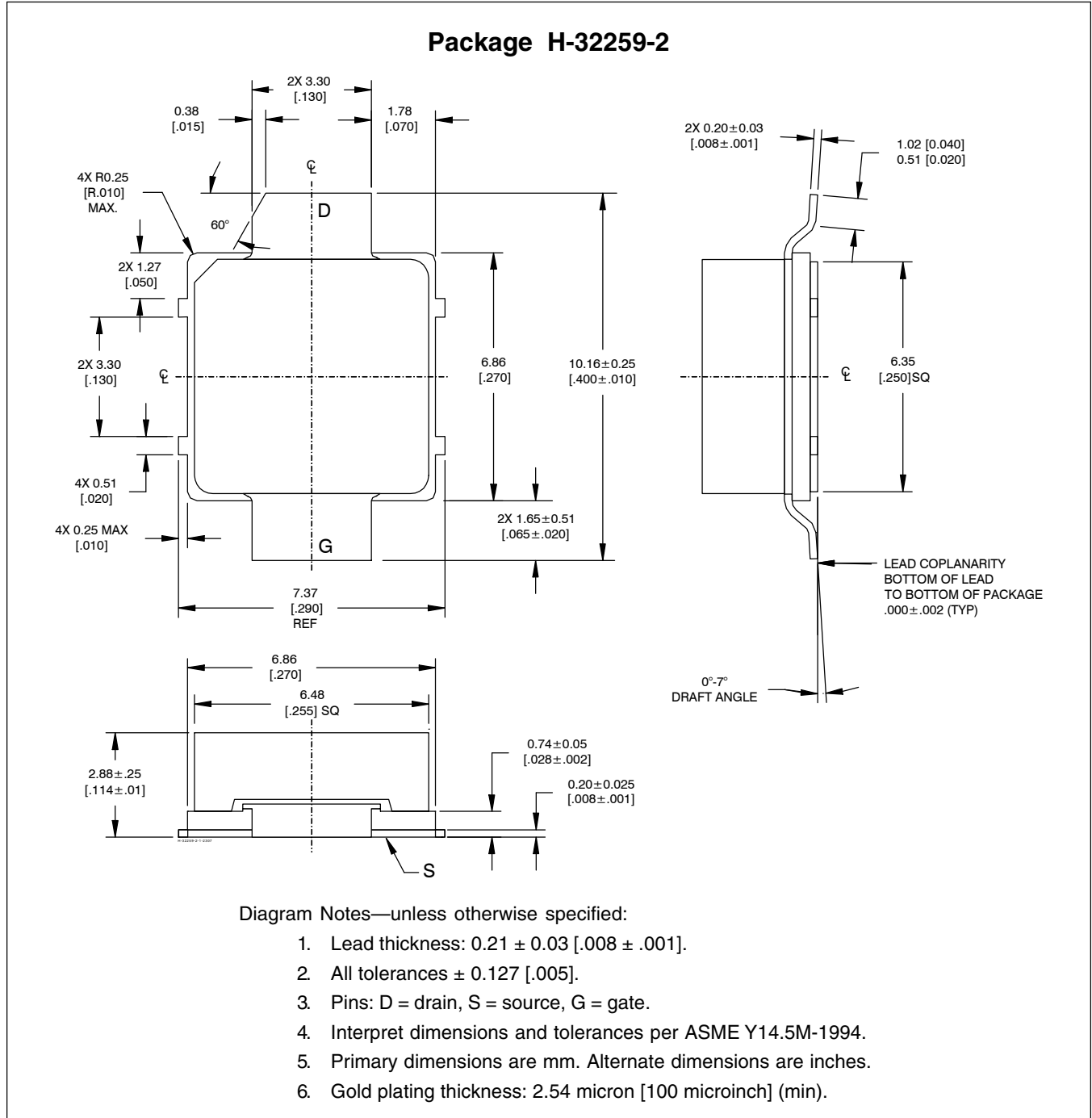

Find the latest and most complete information about products and packaging at the Infineon Internet page <http://www.infineon.com/products>

PTF240101S

Confidential, Limited Internal Distribution

Revision History: 2007-04-12

Data Sheet

Previous Version: 2006-12-15, Data Sheet

Page	Subjects (major changes since last revision)
9, 10	Update and correct circuit diagrams and information

We Listen to Your Comments

Any information within this document that you feel is wrong, unclear or missing at all?
Your feedback will help us to continuously improve the quality of this document.
Please send your proposal (including a reference to this document) to:

highpowerRF@infineon.com

To request other information, contact us at:
+1 877 465 3667 (1-877-GO-LDMOS) USA
or +1 408 776 0600 International

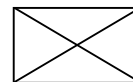

GOLDMOS® is a registered trademark of Infineon Technologies AG.

Edition 2007-04-12

Published by

Infineon Technologies AG

81726 München, Germany

© Infineon Technologies AG 2005.

All Rights Reserved.

Legal Disclaimer

The information given in this document shall in no event be regarded as a guarantee of conditions or characteristics ("Beschaffenhheitsgarantie"). With respect to any examples or hints given herein, any typical values stated herein and/or any information regarding the application of the device, Infineon Technologies hereby disclaims any and all warranties and liabilities of any kind, including without limitation warranties of non-infringement of intellectual property rights of any third party.

Information

For further information on technology, delivery terms and conditions and prices please contact your nearest Infineon Technologies Office (www.infineon.com/rfpower).

Warnings

Due to technical requirements components may contain dangerous substances. For information on the types in question please contact your nearest Infineon Technologies Office.

Infineon Technologies Components may only be used in life-support devices or systems with the express written approval of Infineon Technologies, if a failure of such components can reasonably be expected to cause the failure of that life-support device or system, or to affect the safety or effectiveness of that device or system. Life support devices or systems are intended to be implanted in the human body, or to support and/or maintain and sustain and/or protect human life. If they fail, it is reasonable to assume that the health of the user or other persons may be endangered.