

Integrated White LED Driver With Organic LED Display Power Supply

- Integrated OLED and White-LED Driver
 - Wide Input Voltage Range: 2.7V to 5.5V
 - Adjustable output voltage up to 20V
 - Complete Protection: OVP, OTP, UVP
 - PWM Dimming Control
 - Small External Components
 - Cycle-By-Cycle Current Limit
 - Lead Free, RoHS Compliant
- Packaging: 10Pin DFN

DFN-10
(3mmx3mmx0.85mm)
Top View

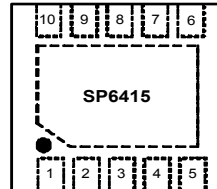

Applications

- White LED Back-Lighting
- Hand-held Devices
- Digital Cameras
- Flip-phones / Clam-shell Cellular Phones
- High-fashion cellular phones

DESCRIPTION

The SP6415 is a dual Boost DC/DC converter, designed to drive up to 4 white LEDs with a constant current and to power an organic LED display with a constant voltage. According to the SEL pin status, the SP6415 either regulates output current flowing through series connected LEDs or regulates output voltage applying to the OLED. A single external resistor is used to set the maximum LED current. The LED current can be adjusted by applying a PWM signal to the EN pin. Pulling the EN pin to GND disables the chip and reduces the supply current to less than 1uA. Additional features include a low-side NFET switch that can turn off the LED string with no DC current path to ground. Other features include OVP, OCP, UVP and OTP. The SP6415 is available in a small (3mmx3mmx0.85mm) DFN-10 package.

TYPICAL APPLICATION CIRCUIT

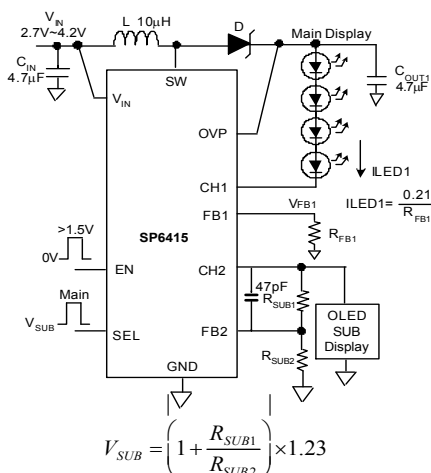

Figure 1. Main LEDs Display and OLED SUB Display

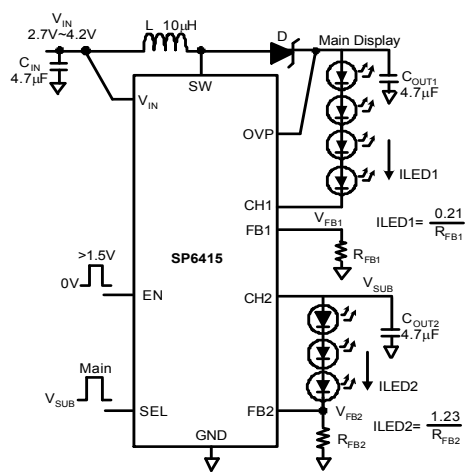

Figure 2. 4 LEDs for Main Panel and 3 LEDs for SUB Panel

Absolute Maximum Ratings

Parameter	Symbol	Maximum	Unit
Input Supply Voltage	V_{IN}	6	V
EN, FB Voltages	V_{EN}, V_{FB}	V_{IN}	
SW Voltage	V_{SW}	30	
ESD Classification	A*		

Caution: Stress above the listed absolute rating may cause permanent damage to the device.

* HBM A: 0V ~ 1999V

Recommended Operating Conditions

Parameter	Symbol	Rating	Unit
Input Supply Voltage	V_{IN}	2.7 to 5.5	V
Ambient Temperature Range	T_A	-40 to +85	°C
Junction Temperature Range	T_J	-40 to +125	

Thermal Information

Parameter	Package	Die Attach	Symbol	Maximum	Unit
Thermal Resistance (Junction to Ambient)	DFN-10 (3x3x0.85)(mm)	Conductive Epoxy	θ_{JA}	48	°C / W
Internal Power Dissipation			P_D	2	W
Maximum Junction Temperature				150	°C
Solder Iron (10 Sec)**				350	°C

* MIL-STD-202G 210F

Electrical Specifications

$V_{IN}=3.6V$, $EN = V_{IN}$, $T_A = 25^{\circ}C$ unless otherwise noted.

Parameter	Symbol	Test Condition	Min	Typ	Max	Units	
Input Voltage Range	V_{IN}	$T_A = -40^{\circ}C$ to $+85^{\circ}C$	2.7		5.5	V	
Main Display Quiescent Current	$I_Q(\text{Main})$	FB = 0.3 (Not Switch)	$T_A = 25^{\circ}C$		150	200	μA
			$T_A = -40$ to $85^{\circ}C$			300	
		FB = 0.1 (Switching)	$T_A = 25^{\circ}C$		150	250	
			$T_A = -40$ to $85^{\circ}C$			400	
SUB Display Quiescent Current	$I_Q(\text{SUB})$	FB = 1.3V (Not Switch)	$T_A = 25^{\circ}C$		150	200	μA
			$T_A = -40$ to $85^{\circ}C$			300	
		FB = 1.15V (Switching)	$T_A = 25^{\circ}C$		150	250	
			$T_A = -40$ to $85^{\circ}C$			400	
Shutdown Current	I_{SD}	EN = 0V		0.05	2	μA	
FB1 Feedback Voltage	V_{FB1}	$T_A = -40$ to $85^{\circ}C$	0.2	0.21	0.23	V	
FB2 Feedback Voltage	V_{FB2}	$T_A = -40$ to $85^{\circ}C$	1.2	1.23	1.26		
Switch Current Limit	I_{CL}	$T_A = 25^{\circ}C$	300	350	400	mA	
		$T_A = -40$ to $85^{\circ}C$	280		400		
Main_Switch $R_{DSON, N1}$	R_{DSON}	$T_A = -40$ to $85^{\circ}C$		0.6	1.6	Ω	
PMOS Switch $R_{DSON, P1}$				8	10		
NMOS Switch $R_{DSON, N2}$				6	8		
Switch off time	t_{OFF}			400		ns	
Input Under Voltage Lockout	UVP	$T_A = -40$ to $85^{\circ}C$	1.7	2	2.3	V	
Output Over Voltage Protection	OVP	$T_A = -40$ to $85^{\circ}C$	21	22	23		
Over Temperature Protection	OTP			160		$^{\circ}C$	
Over Temperature Hysteresis	OTH			20			
Main Switch Leakage N1	I_{SW}	$V_{SW} = 5V$		0.1	2	μA	
PMOS Switch Leakage P1				0.5	1		
NMOS Switch Leakage N2				0.5	1		
EN Input Threshold (Low) (Shutdown)	EN Threshold	$T_A = -40$ to $85^{\circ}C$			0.4	V	
EN Input Threshold (High) (Enable the device)				1.5			
Sel Low Level Voltage Enable SUB Display Disable Main Display	SEL Threshold	$T_A = -40$ to $85^{\circ}C$			0.3	V	
Sel High Level Voltage Enable Main Display Disable SUB Display				1.5			

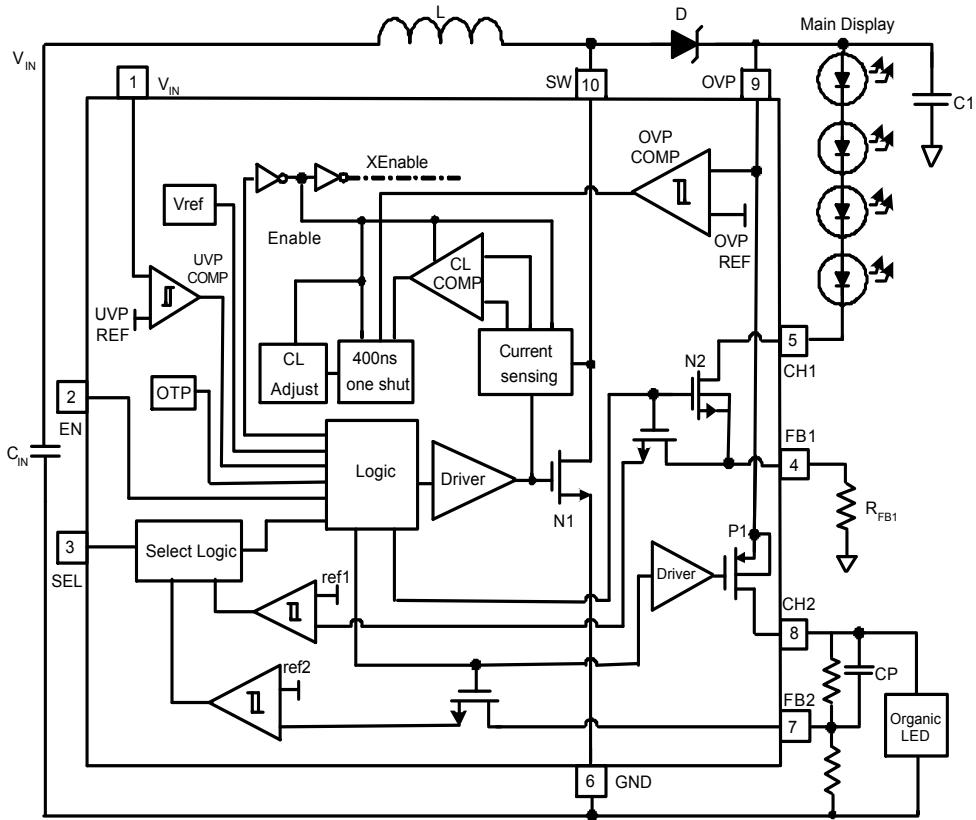
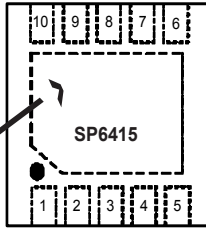

Figure 3. SP6415 Functional Block Diagram

DFN-10
(3mmx3mmx0.85mm)
Top View



Note : The area enclosed by dashed line represents Exposed Pad and connects to GND.

* Die Attach:
Conductive Epoxy

Pin Description

Pin Number	Pin Name	Pin Description
1	V _{IN}	Input Voltage.
2	EN	Shutdown control input, active low. The shutdown pin is an active low control. Tie this pin above 1.5V to enable the device. Tie this pin below 0.4V to turn off the device.
3	SEL	Selection Pin. Internal MOSFET selection. Pull low to turn on the internal CH1. Pull high to turn on CH2.
4	FB1	Main Display Feedback.
5	CH1	Main Display Return Voltage
6	GND	Ground.
7	FB2	SUB Display Feedback.
8	CH2	SUB Display Power Supply Voltage. $V_{SUB} = \left(1 + \frac{R_{SUB1}}{R_{SUB2}}\right) \times 1.23$
9	OVP	Over Voltage Protection.
10	SW	This is the switch pin and is connected to the drain of the internal NMOS power switch N1.

The SP6415 is designed for white LED & OLED back-lighting in mobile phone applications. It has a main display loop which can drive up to 4 white LEDs in series and a SUB display loop which is designed to drive OLED up to 20V/10mA or 3 white LEDs.

The SP6415 operates at a wide input voltage range suitable for Li-ion battery and has a constant off time for smaller inductor and capacitors. The block diagram refers the operation circuit. By SEL pin, it can choose the different channel to turn on CH1 or CH2.

Current Limit Protection

The SP6415 has current limiting protection to prevent excessive stress on itself and external components during overload conditions. The internal current limit comparator will disable the NMOS power device at a typical switch peak current limit of 300mA.

Output Over-Voltage Protection

The SP6415 contains dedicated circuitry for monitoring the output voltage. In the event that the primary LED network is disconnected the output will increase and be limited to 22V(typ.). There is a ~1V hysteresis associated with this circuitry, which will turn the NMOS off when the output voltage is at 23V(max.) until the output voltage reach 21V(typ.) or lower. The 22V limit allows the use of 25V 1 μ F ceramic output capacitors creating an overall small solution for white LED applications.

Under Voltage Protection

The SP6415 has a UVP comparator to turn the NMOS power device off in case the input voltage or battery voltage is too low, preventing an on state of the power device conducting large amounts of current. There is a ~1V hysteresis associated with this circuitry, which will turn the NMOS off when the output voltage is at 23V(max.) until the output voltage reaches 21V(typ.) or lower. The 22V limit allows the use of 25V 1mF ceramic output capacitors creating an overall small solution for white LED applications.

Application Information

Inductor Selection

The recommended value of inductor for SP6415 applications is 10 μ H. Small size and better efficiency are the major concerns for portable device, such as SP6415 used for dual panel mobile phone. The inductor should have low DCR for better efficiency. To avoid inductor saturation, current rating should be at least 600mA. The input range is 2.7V to 5.5V.

Capacitor Selection

A 4.7 μ F input capacitor can reduce input ripple. For better voltage stability, to increase the input capacitor value or using an LC filter is feasible, especially in Li-Ion battery applications. The input capacitor acts as a bypass to the IC and needs to be connected directly to the VIN pin and the GND pin for proper low ripple regulation.

The output capacitor needs to be a minimum of 1 μ F with 25V rating. For applications with 5V input, an output capacitor of 2.2 μ F or 4.7 μ F may be needed to lower output ripple and improve regulation. For better voltage filtering, ceramic capacitors with low ESR are recommended. X5R and X7R types are suitable because of their wider voltage and temperature ranges.

Diode Selection

A Schottky diode is a good choice for SP6415 because of its lower forward voltage drop and faster reverse recovery. Using Schottky diodes can help obtain better efficiency. High speed rectification is also a good characteristic of Schottky diodes for high switching frequency. Current rating of the diode must meet the root mean square of the peak current and output average current multiplication.

Feedback Voltage vs. V_{IN} (4LEDs)

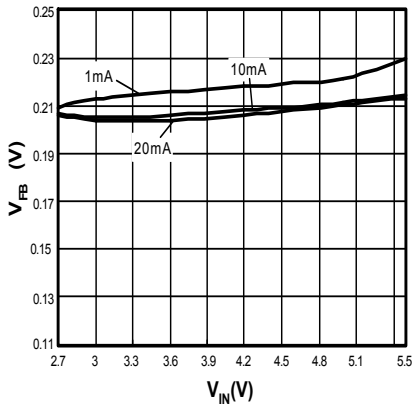

EN Threshold vs. V_{IN}

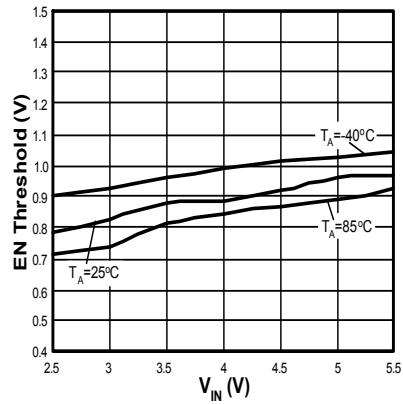

Feedback Voltage vs. V_{IN} (3LEDs)

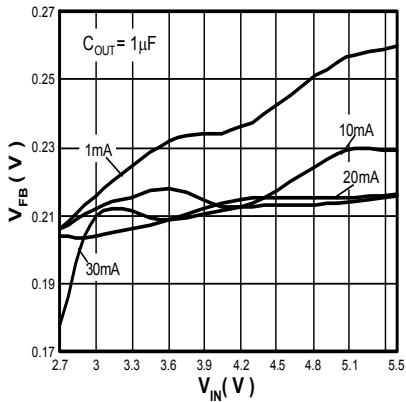

Feedback Voltage vs. V_{IN} (3LEDs)

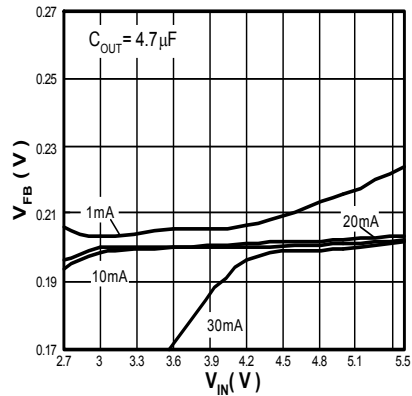

Main Display Efficiency (4LEDs)

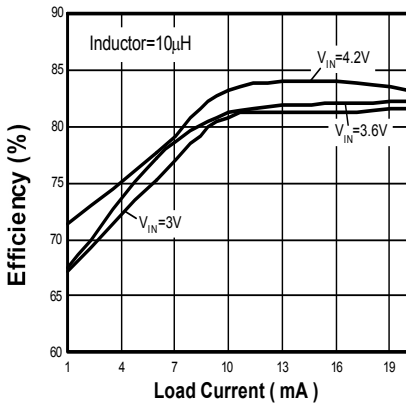

Main Display Efficiency (4LEDs)

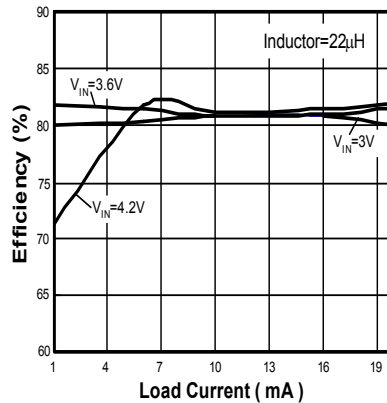

Main Display Efficiency (3LEDs)

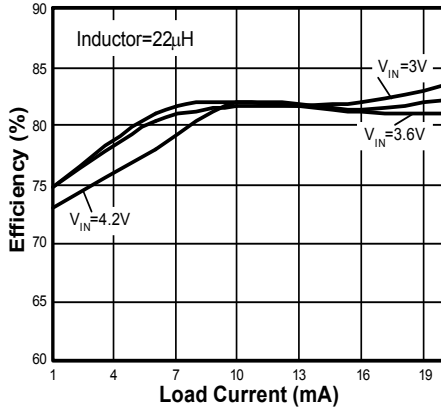

Main Display Efficiency (3LEDs)

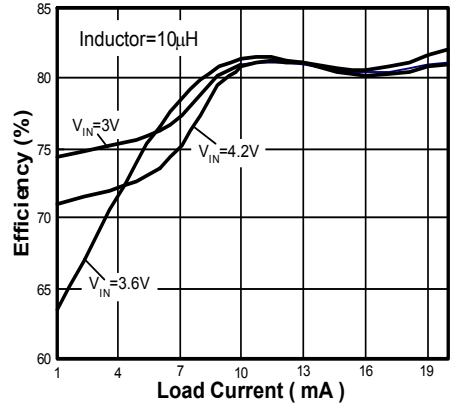

Sub Display Efficiency ($V_{SUB}=12V$)

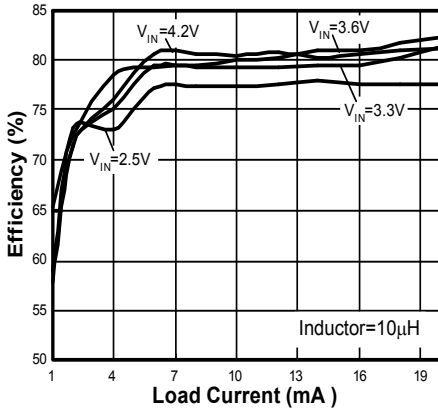

Sub Display Efficiency ($V_{SUB}=12V$)

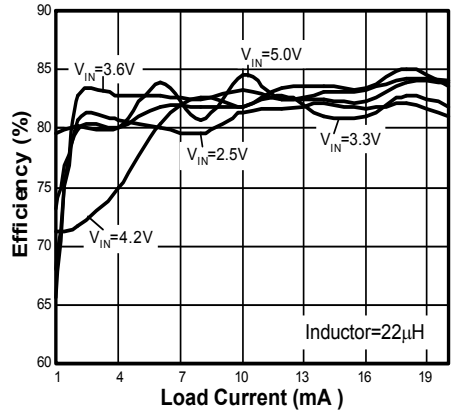

Sub Display Efficiency ($V_{SUB}=20V$)

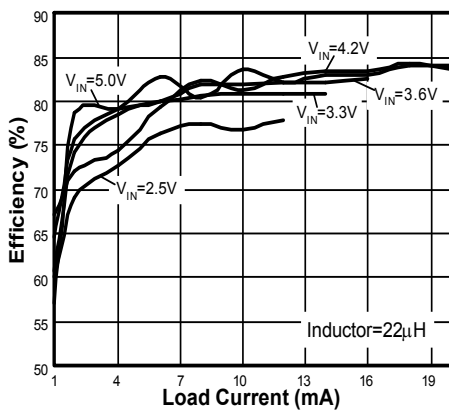

Sub Display Efficiency ($V_{SUB}=20V$)

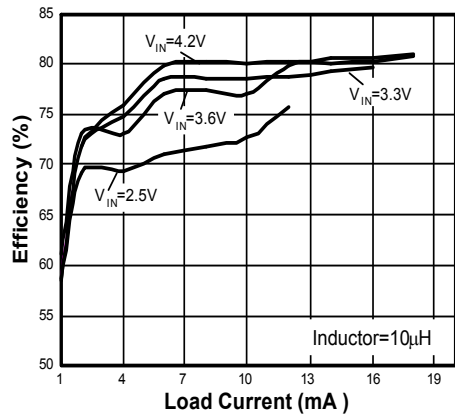

Sub Enable Current vs. V_{IN}
(Part not Switching)

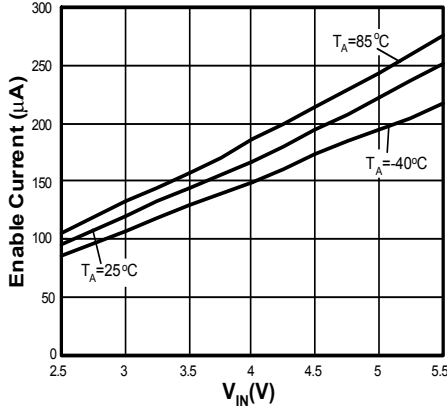

Main Enable Current vs. V_{IN}
(Part Switching)

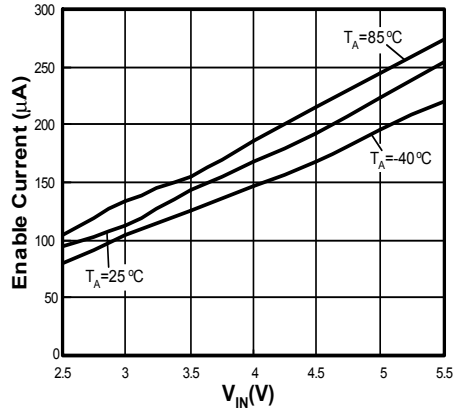

Main Disable Current vs. V_{IN}
(Part Switching)

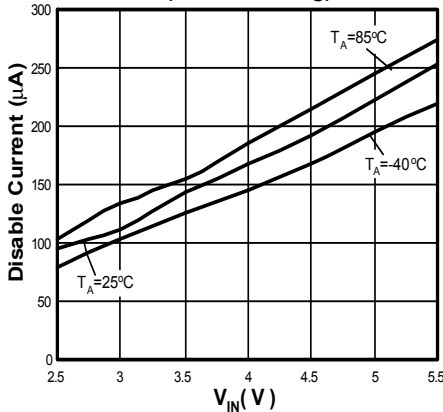

Sub Disable Current vs. V_{IN}
(Part not Switching)

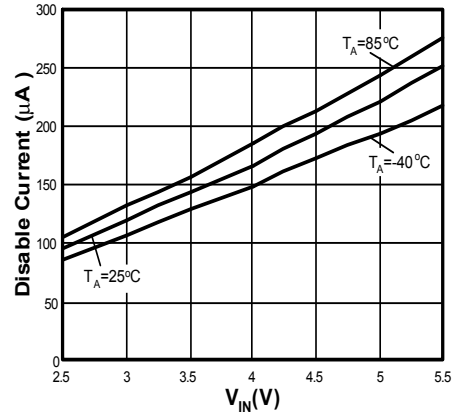

Switch $R_{DS(on)}$ vs. V_{IN}

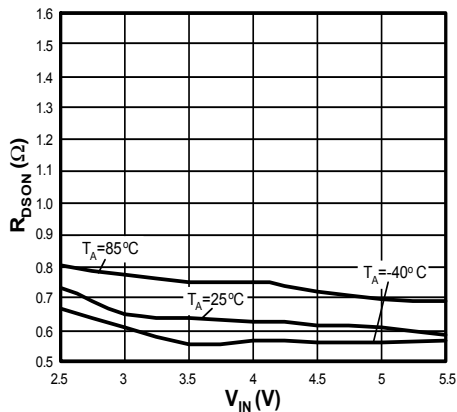

Input Under Voltage Lockout vs. Temp.

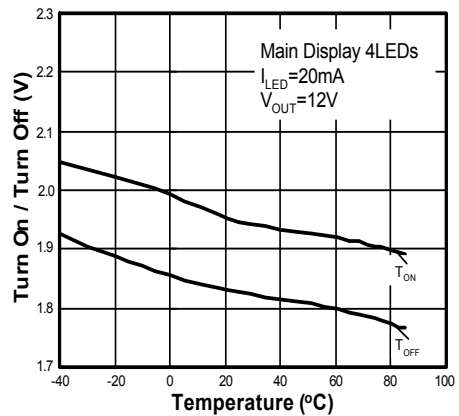

Typical Switching Waveform

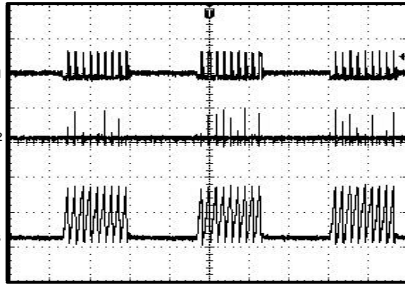

$V_{OUT} = 12V$, $V_{IN} = 2.5V$; 4LEDs
 $I_{OUT} = 10mA$ ($R_{FB1} = 20\Omega$)
 1) $V_{SW} = 20V/div, DC$
 2) $V_{OUT+} = 100mV / div, AC$
 3) Inductor Current, 200mA / div, DC
 $T = 10\mu S / div$
 Inductor = 10 μH , $C_{OUT} = 4.7\mu F$

Typical Switching Waveform

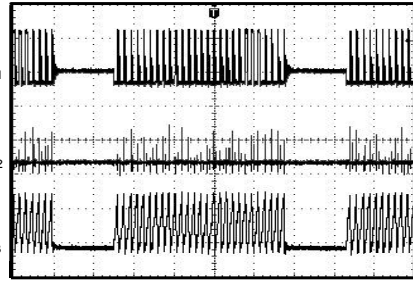

$V_{OUT} = 12V$, $V_{IN} = 3.6V$; 4LEDs
 $I_{OUT} = 20mA$ ($R_{FB1} = 10\Omega$)
 1) $V_{SW} = 10V/div, DC$
 2) $V_{OUT+} = 100mV / div, AC$
 3) Inductor Current, 200mA / div, DC
 $T = 10\mu S / div$
 Inductor = 10 μH , $C_{OUT} = 4.7\mu F$

Step Response

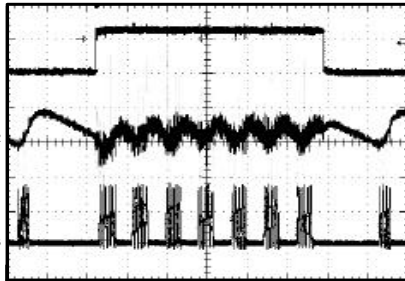

$V_{OUT} = 12V$, $V_{IN} = 3.6V$
 1) Load 2mA to 15mA / div, DC
 2) $V_{OUT+} = 100mA / div, AC$
 3) Inductor Current 200mA / div, DC
 $T = 20\mu S / div$

Start-Up/Shutdown

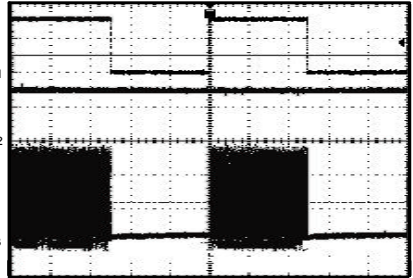

$V_{OUT} = 12V$, $V_{IN} = 2.7V$
 1) EN, 1V / div, DC
 2) $V_{OUT+} = 10/div, DC$
 3) Inductor Current 100mA/div, DC
 Load = 4LEDs, $T = 2ms/div$

FB Trip Point vs Temperature
 SUB Display

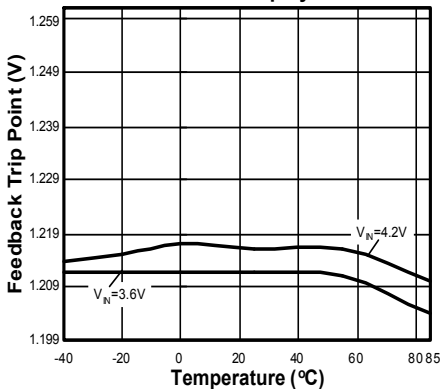

Output Over Voltage Protection vs. Temp.

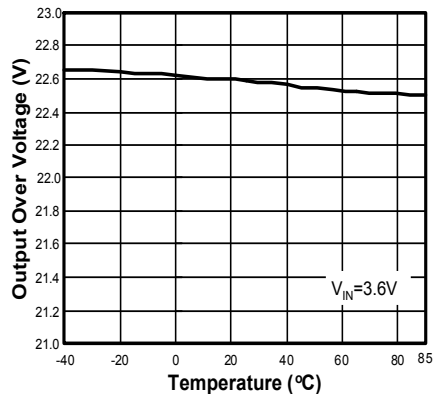

Package Dimension

DFN-10
(3mmx3mmx0.85mm)

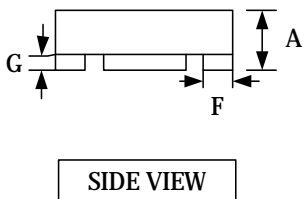
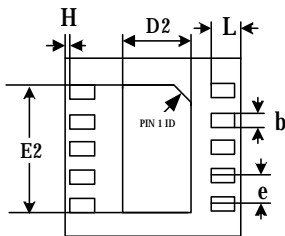
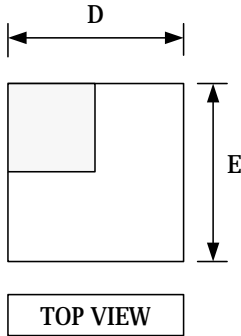

SYMBOLS	MILLIMETERS		INCHES	
	MIN	MAX	MIN	MAX
A		0.900		0.035
D	2.900	3.100	0.114	0.122
E	2.900	3.100	0.114	0.122
F	0.450 TYP.		0.017 TYP.	
e	0.450	0.550	0.018	0.022
D2	1.600 TYP.		0.063 TYP.	
E2	2.400 TYP.		0.094 TYP.	
b	0.150	0.250	0.0059	0.010
L	0.350	0.450	0.014	0.018
G	0.010	0.090	0.0004	0.004
H	0.000	0.050	0.000	0.002

Part Number	Voltage	Operating Temperature Range	Package	Marking*	Pack Quantity
SP6415ER-L/TR	ADJ	-40°C to +85°C	Lead Free 10 Pin DFN	SP6415ERYWWX	1,000/ Tape & Reel

*Note: "Y" = Year, "WW" = Product Work Week, "X" = 1st Alpha of Lot Number



Sipex Corporation

**Headquarters and
Sales Office**

233 South Hillview Drive
Milpitas, CA 95035
TEL: (408) 934-7500
FAX: (408) 935-7600

Sipex Corporation reserves the right to make changes to any products described herein. Sipex does not assume any liability arising out of the application or use of any product or circuit described herein; neither does it convey any license under its patent rights nor the rights of others.