



MULTI-INNO TECHNOLOGY CO., LTD.

LCD MODULE SPECIFICATION

Model : MI0283QT-1

Revision	1.0
Engineering	
Date	
Our Reference	



REVISION RECORD

REV NO.	REV DATE	CONTENTS	REMARKS
1.0	2008-8-26	First Release	

www.DataSheet4U.com



CONTENTS

- n GENERAL INFORMATION
- n EXTERNAL DIMENSIONS
- n ABSOLUTE MAXIMUM RATINGS
- n ELECTRICAL CHARACTERISTICS
- n TIMING OF POWER SUPPLY
- n BACKLIGHT CHARACTERISTICS
- n ELECTRO-OPTICAL CHARACTERISTICS
- n INTERFACE DESCRIPTION
- n REFERENCE APPLICATION CIRCUIT
- n REFERENCE INITIAL CODE
- n RELIABILITY TEST
- n INSPECTION CRITERION
- n PRECAUTIONS FOR USING LCD MODULES
- n PRIOR CONSULT MATTER

www.DataSheet4U.com

WRITTEN BY	CHECKED BY	APPROVED BY

n GENERAL INFORMATION

Item	Contents	Unit/Note
LCD Type	TFT TRANSMISSIVE	/
Viewing direction	12:00 O' Clock	6:00O'Clock (Good viewing)
Module area (W × H)	50.20 × 69.30	mm ²
Viewing area (W×H)	44.80×59.20	mm ²
Active area (W×H)	43.20 × 57.60(LCD)	mm ²
Number of Dots	240 (RGB) × 320	/
Driver IC	R61505U	/
Colors	262K	/
Backlight Type	LED	/
Module Power consumption	226	mw
Interface Type	System parallel interface	/
Input voltage	2.8/1.8	V

EXTERNAL DIMENSIONS

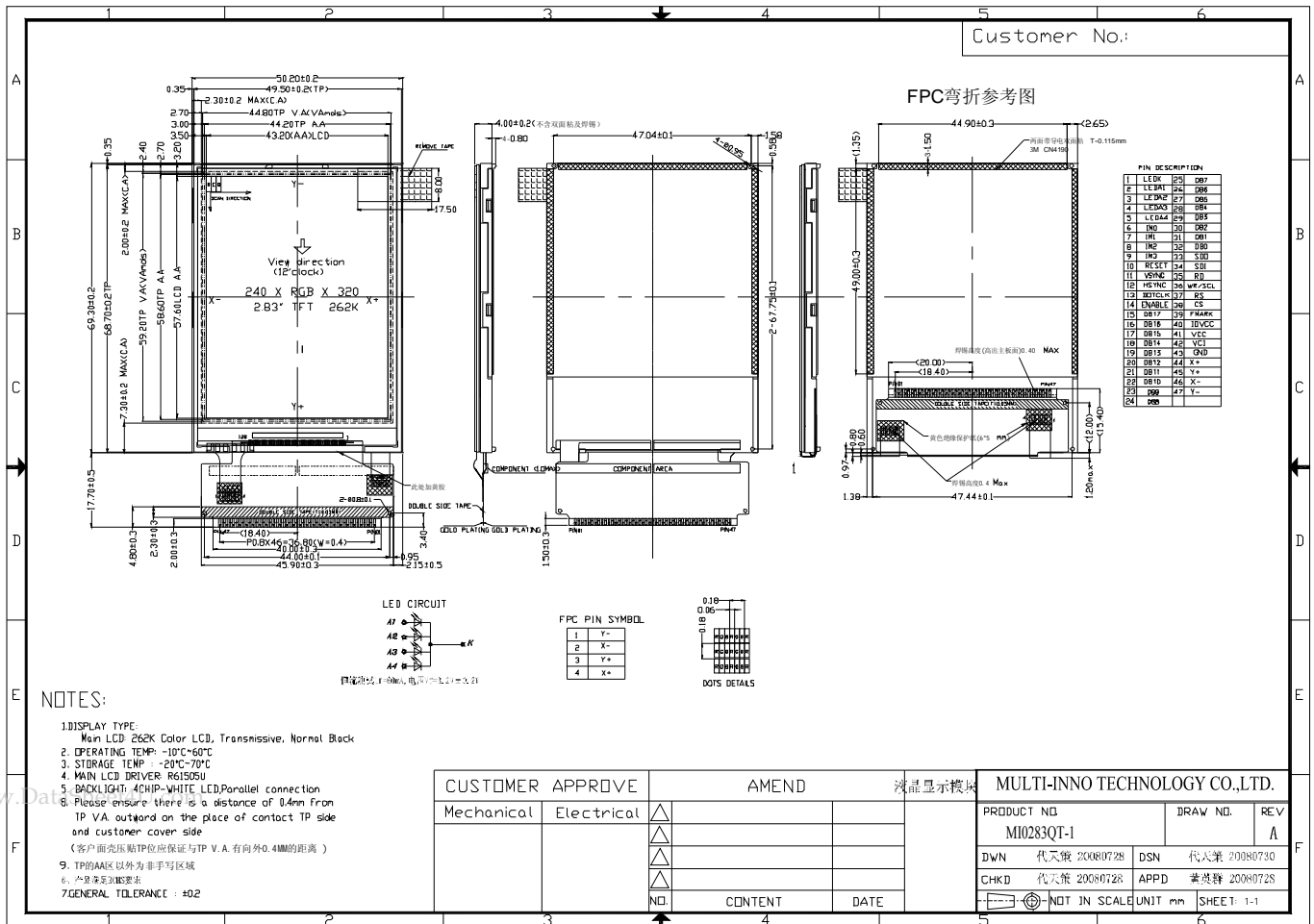

■ ABSOLUTE MAXIMUM RATINGS

Parameter	Symbol	Min	Max	Unit
Supply voltage range	$IOV_{CC}/V_{CC}/V_{CI}$	-0.3	4.6	V
Input voltage	V_{IN}	-0.3	$IOV_{CC}+0.3$	V
Operating temperature	T_{OP}	-20	70	°C
Storage temperature	T_{ST}	-30	80	°C
Humidity	RH	-	90%(Max60°C)	RH

■ ELECTRICAL CHARACTERISTICS

DC CHARACTERISTICS

Parameter	Symbol	Min	Typ	Max	Unit
Supply voltage for logic	V_{CC}	2.5	2.8	3.3	V
Supply voltage for analog	V_{CI}	2.5	2.8	3.3	V
Supply voltage for I/O	IOV_{CC}	1.65	2.8	3.3	V
Input Current	I_{dd}	-	12.1	24.2	mA
Input voltage 'H' level	V_{IH}	$0.8IOV_{CC}$	-	IOV_{CC}	V
Input voltage 'L' level	V_{IL}	-0.3	-	$0.2IOV_{CC}$	V
Output voltage 'H' level	V_{OH}	$0.8IOV_{CC}$	-	-	V
Output voltage 'L' level	V_{OL}	-	-	$0.2IOV_{CC}$	V

■ TIMING OF POWER SUPPLY

PLEASE REFER TO THE DRIVER IC SPECIFICATION.

■ BACKLIGHT CHARACTERISTICS

Item	Symbol	Min.	Typ.	Max.	Unit	Condition
Forward voltage	V_f	3.0	3.2	3.4	V	$I_f=60mA$
Luminance	L_v	2000	2400	2800	cd/m ²	
Number of LED	-	4			Piece	-
Connection mode	P	Parallel			-	-

Using condition: constant current driving method $I_f=60mA$ (+/-10%).

■ELECTRO-OPTICAL CHARACTERISTICS

Item	Symbol	Condition	Min	Typ	Max	Unit	Remark	Note
Response time	Tr+Tf	$\theta=0^\circ$ $\varnothing=0^\circ$ Ta=25°C	---	27.7	41.55	ms	FIG 1.	4
Contrast ratio	Cr		337	674	---	---	FIG 2.	1
Luminance uniformity	δ WHITE		75	83	---	%	FIG 2.	3
Surface Luminance	Lv		159	199	---	cd/m ²	FIG 2.	2
Viewing angle range	θ	$\varnothing = 90^\circ$	70	80	---	deg	FIG 3.	6
		$\varnothing = 270^\circ$	55	65	---	deg	FIG 3.	
		$\varnothing = 0^\circ$	63	73	---	deg	FIG 3.	
		$\varnothing = 180^\circ$	61	71	---	deg	FIG 3.	
CIE (x, y) chromaticity	Red	x	0.5527	0.6027	0.6527	-	FIG 2.	5
		y	0.2998	0.3498	0.3998			
	Green	x	0.2677	0.3177	0.3677			
		y	0.5187	0.5687	0.6187			
	Blue	x	0.0956	0.1456	0.1956			
		y	0.0318	0.0818	0.1318			
	White	x	0.2218	0.2818	0.3418			
		y	0.2423	0.3023	0.3623			

Note 1. Contrast Ratio(CR) is defined mathematically as For more information see FIG 2.:

$$\text{Contrast Ratio} = \frac{\text{Average Surface Luminance with all white pixels (P}_1, \text{P}_2, \text{P}_3, \text{P}_4, \text{P}_5)}{\text{Average Surface Luminance with all black pixels (P}_1, \text{P}_2, \text{P}_3, \text{P}_4, \text{P}_5)}$$

Note 2. Surface luminance is the LCD surface from the surface with all pixels displaying white. For more information see FIG 2.

$$L_v = \text{Average Surface Luminance with all white pixels (P}_1, \text{P}_2, \text{P}_3, \text{P}_4, \text{P}_5)$$

Note 3. The uniformity in surface luminance, δ WHITE is determined by measuring luminance at each test position 1 through 5, and then dividing the maximum luminance of 5 points luminance by minimum luminance of 5 points luminance. For more information see FIG 2.

$$\delta \text{ WHITE} = \frac{\text{Minimum Surface Luminance with all white pixels (P}_1, \text{P}_2, \text{P}_3, \text{P}_4, \text{P}_5)}{\text{Maximum Surface Luminance with all white pixels (P}_1, \text{P}_2, \text{P}_3, \text{P}_4, \text{P}_5)}$$

Note 4. Response time is the time required for the display to transition from White to black(Rise Time, Tr) and from black to white(Decay Time, Tf). For additional information see FIG 1. The test equipment is Autronic-Melchers's ConoScope. Series

Note 5. CIE (x, y) chromaticity, The x,y value is determined by measuring luminance at each test position 1 through 5, and then make average value

Note 6. Viewing angle is the angle at which the contrast ratio is greater than 2. For TFT module the contrast ratio is greater than 10. The angles are determined for the horizontal or x axis and the vertical or y axis with respect to the z axis which is normal to the LCD surface. For more information see FIG 3.

www.DataSheet4U.com

Note 7. For Viewing angle and response time testing, the testing data is base on Autronic-Melchers's ConoScope. Series Instruments. For contrast ratio, Surface Luminance, Luminance uniformity, CIE The test data is base on TOPCON's BM-5 photo detector.

Note 8. For TFT module, Gray scale reverse occurs in the direction of panel viewing angle.

FIG.1. The definition of Response Time

The response time is defined as the following figure and shall be measured by switching the input signal for “black” and “white”.

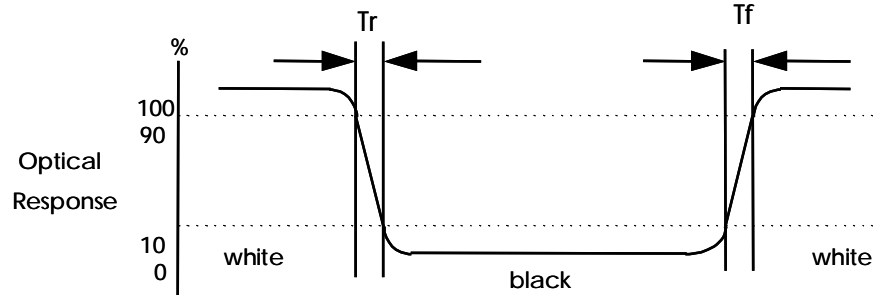
FIG.2. Measuring method for Contrast ratio, surface luminance, Luminance uniformity, CIE (x, y) chromaticity

A : 5 mm
 B : 5 mm
 H, V : Active Area
 Light spot size $\varnothing=7\text{mm}$, 500mm distance from the LCD surface to detector lens
 measurement instrument is TOPCON's luminance meter BM-5

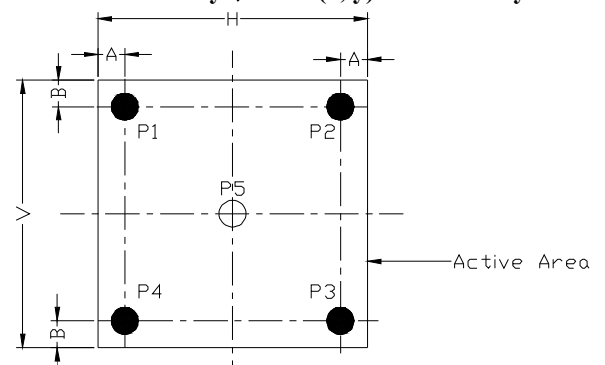
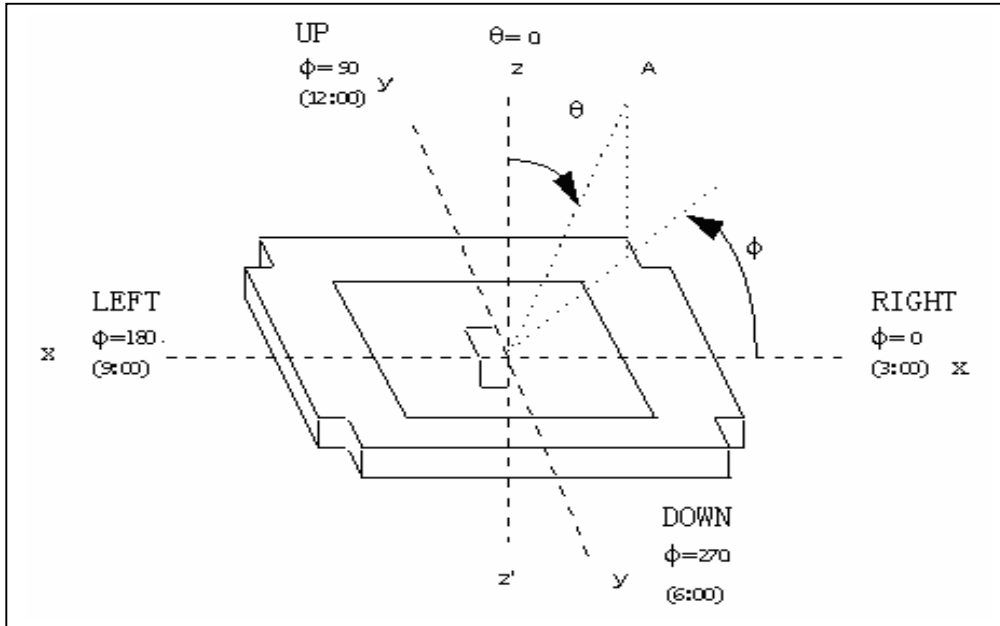
FIG.3. The definition of viewing angle

■ INTERFACE DESCRIPTION

Pin No.	Symbol	Level	Description																														
1	LEDK	-	LED light cathode.																														
2~5	LEDA1~A4	-	LED light anode.																														
6~9	IM0 IM1 IM2 IM3	H/L	Select a mode to interface to an MPU. In SPI mode, the IM0 pin is used to set the ID of device code.																														
			<table border="1"> <thead> <tr> <th>IM[3:0]</th> <th>Interface Mode</th> <th>DB Pins</th> </tr> </thead> <tbody> <tr> <td>000*</td> <td>Setting disabled</td> <td>-</td> </tr> <tr> <td>0010</td> <td>80-system 16-bit interface</td> <td>DB[17:10], DB[8:1]</td> </tr> <tr> <td>0011</td> <td>80-system 8-bit interface</td> <td>DB[17:10]</td> </tr> <tr> <td>010*</td> <td>Serial peripheral interface (SPI)</td> <td>SDI, SDO</td> </tr> <tr> <td>011*</td> <td>Setting disabled</td> <td>-</td> </tr> <tr> <td>100*</td> <td>Setting disabled</td> <td>-</td> </tr> <tr> <td>1010</td> <td>80-system 18-bit interface</td> <td>DB[17:0]</td> </tr> <tr> <td>1011</td> <td>80-system 9-bit interface</td> <td>DB[17:9]</td> </tr> <tr> <td>11**</td> <td>Setting disabled</td> <td>-</td> </tr> </tbody> </table>	IM[3:0]	Interface Mode	DB Pins	000*	Setting disabled	-	0010	80-system 16-bit interface	DB[17:10], DB[8:1]	0011	80-system 8-bit interface	DB[17:10]	010*	Serial peripheral interface (SPI)	SDI, SDO	011*	Setting disabled	-	100*	Setting disabled	-	1010	80-system 18-bit interface	DB[17:0]	1011	80-system 9-bit interface	DB[17:9]	11**	Setting disabled	-
			IM[3:0]	Interface Mode	DB Pins																												
			000*	Setting disabled	-																												
			0010	80-system 16-bit interface	DB[17:10], DB[8:1]																												
			0011	80-system 8-bit interface	DB[17:10]																												
			010*	Serial peripheral interface (SPI)	SDI, SDO																												
			011*	Setting disabled	-																												
			100*	Setting disabled	-																												
			1010	80-system 18-bit interface	DB[17:0]																												
1011	80-system 9-bit interface	DB[17:9]																															
11**	Setting disabled	-																															
10	RESET	H/L	Reset signal.																														
11	VSYNC	H/L	Frame synchronous signal for RGB interface operation.																														
12	HSYNC	H/L	Line synchronous signal for RGB interface operation.																														
13	DOTCLK	H/L	Dot clock signal for RGB interface operation.																														
14	ENABLE	H/L	Data enable signal for RGB interface operation.																														
15~32	DB17~DB0	H/L	Data bus.																														
33	SDO	H/L	Serial data output pin in SPI mode.																														
34	SDI	H/L	Serial data input pin in SPI mode.																														
35	RD	H/L	Read signal.																														
36	WR/SCL	H/L	Write strobe signal in 80-system bus interface operation and enables write operation when WR is low. Synchronous clock signal (SCL) in serial interface operation.																														
37	RS	H/L	Command / data select.																														
38	CS	H/L	Chip selection.																														
39	FMARK	H/L	Frame head pulse signal.																														
40	IOVCC	1.65~3.3V	Interface I/O power supply.																														
41	VCC	2.5~3.3V	Logic regulator power supply.																														
42	VCI	2.5~3.3V	Liquid crystal analog circuit power supply.																														
43	GND	0V	Ground.																														
44	X+	-	Touch panel coordinate in the right side of envisage drawing.																														
45	Y+	-	Touch panel coordinate in the down side of envisage drawing.																														
46	X-	-	Touch panel coordinate in the left side of envisage drawing.																														
47	Y-	-	Touch panel coordinate in the up side of envisage drawing.																														

■ APPLICATION CIRCUIT

Please consult our technical department for detail information.

■ INITIAL CODE

Please consult our technical department for detail information

■ RELIABILITY TEST

No.	Test Item	Test Condition	Inspection after test
1	High Temperature Storage	80±2°C/200 hours	Inspection after 2~4hours storage at room temperature, the sample shall be free from defects: 1.Air bubble in the LCD; 2.Sealleak; 3.Non-display; 4.missing segments; 5.Glass crack; 6.Current Idd is twice higher than initial value. 7. The surface shall be free from damage. 8.Linearity must be no more than 1.5% by the linearity tester. 9..The Electric characteristics requirements shall be satisfied.
2	Low Temperature Storage	-30±2°C/200 hours	
3	High Temperature Operating	70±2°C/120 hours	
4	Low Temperature Operating	-20±2°C/120 hours	
5	Temperature Cycle	-20±2°C~25~70±2°C×10cycles (30min.) (5min.) (30min.)	
6	Damp Proof Test	50°C ± 5°C × 90%RH/120 hours	
7	Vibration Test	Frequency: 10Hz~55Hz~10Hz Amplitude: 1.5mm, X, Y, Z direction for total 3hours (Packing condition)	
8	Drooping test	Drop to the ground from 1m height, one time, every side of carton. (Packing condition)	
9	ESD test	Voltage: ± 8KV R: 330 Ω C: 150pF Air discharge, 10time	
10	Hitting test	1,000,000 times in the same point, Hitting pad: tip R3.75 mm,Silicone rubber, Hardness:40 deg.; Load: 2.45N; Hitting speed: Twice/sec; Electric load: None; Test area should be at 1.8 mm inside of insulation.	
11	Pen sliding durability test	100,000 times minimum Hitting pad: tip R0.8 mm Plastic pen; Load: 1.47N; Sliding speed: 60 mm/sec; Electric load: None Test area should be at 1.8 mm inside of insulation.	
Remark: 1.The test samples should be applied to only one test item. 2.Sample size for each test item is 5~10pcs. 3.For Damp Proof Test, Pure water(Resistance>10MΩ) should be used. 4.In case of malfunction defect caused by ESD damage, if it would be recovered to normal state after resetting, it would be judge as a good part. 5.EL evaluation should be excepted from reliability test with humidity and temperature: Some defects such as black spot/blemish can happen by natural chemical reaction with humidity and Fluorescence EL has. 6.Failure Judgment Criterion: Basic Specification, Electrical Characteristic, Mechanical Characteristic, Optical Characteristic.			

■ INSPECTION CRITERION

This specification is made to be used as the standard acceptance/rejection criteria for Color mobile phone LCM with touch panel.

1 Sample plan

Sampling plan according to GB/T2828.1-2003/ISO 2859-1: 1999 and ANSI/ASQC Z1.4-1993, normal level 2 and based on:

Major defect: AQL 0.65

Minor defect: AQL 1.5

2. Inspection condition

Viewing distance for cosmetic inspection is about 30cm with bare eyes, and under an environment of 20~40W light intensity, all directions for inspecting the sample should be within 45° against perpendicular line.

3. Definition of inspection zone in LCD.

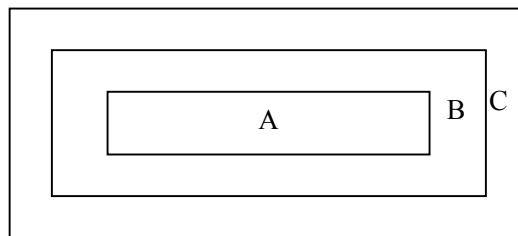

Zone A: character/Digit area

Zone B: viewing area except Zone A (ZoneA+ZoneB=minimum Viewing area)

Zone C: Outside viewing area (invisible area after assembly in customer's product)

Fig.1 Inspection zones in an LCD.

Note: As a general rule, visual defects in Zone C are permissible, when it is no trouble for quality and assembly of customer's product.

4. Inspection standards

4.1 Major Defect

Item No	Items to be inspected	Inspection Standard	Classification of defects
4.1.1	All functional defects	1) No display 2) Display abnormally 3) Missing vertical, horizontal segment 4) Short circuit 5) Back-light no lighting, flickering and abnormal lighting.	Major
4.1.2	Missing	Missing component	
4.1.3	Outline dimension	Overall outline dimension beyond the drawing is not allowed.	
4.1.4	linearity	No more than 1.5%	

4.2 Cosmetic Defect

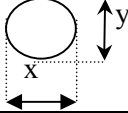
Item No	Items to be inspected	Inspection Standard	Classification of defects																							
4.2.1	Clear Spots Black and white Spot defect Pinhole, Foreign Particle, polarizer Dirt	For dark/white spot, size Φ is defined as $\Phi = \frac{(x+y)}{2}$ 	Minor																							
	Clear Spots TP Dirt	1. <table border="1" style="width: 100%; border-collapse: collapse; text-align: center;"> <thead> <tr> <th rowspan="2">Zone Size(mm)</th> <th colspan="3">Acceptable Qty</th> </tr> <tr> <th>A</th> <th>B</th> <th>C</th> </tr> </thead> <tbody> <tr> <td>$\Phi \leq 0.1$</td> <td colspan="3">Ignore</td> </tr> <tr> <td>$0.10 < \Phi \leq 0.15$</td> <td colspan="3">2</td> </tr> <tr> <td>$0.15 < \Phi \leq 0.20$</td> <td colspan="3">1</td> </tr> <tr> <td>$0.20 < \Phi$</td> <td colspan="3">0</td> </tr> </tbody> </table>		Zone Size(mm)	Acceptable Qty			A	B	C	$\Phi \leq 0.1$	Ignore			$0.10 < \Phi \leq 0.15$	2			$0.15 < \Phi \leq 0.20$	1			$0.20 < \Phi$	0		
Zone Size(mm)	Acceptable Qty																									
	A	B	C																							
$\Phi \leq 0.1$	Ignore																									
$0.10 < \Phi \leq 0.15$	2																									
$0.15 < \Phi \leq 0.20$	1																									
$0.20 < \Phi$	0																									
		2. <table border="1" style="width: 100%; border-collapse: collapse; text-align: center;"> <thead> <tr> <th rowspan="2">Zone Size(mm)</th> <th colspan="3">Acceptable Qty</th> </tr> <tr> <th>A</th> <th>B</th> <th>C</th> </tr> </thead> <tbody> <tr> <td>$\Phi \leq 0.1$</td> <td colspan="3">Ignore</td> </tr> <tr> <td>$0.10 < \Phi \leq 0.15$</td> <td colspan="3">3</td> </tr> <tr> <td>$0.15 < \Phi \leq 0.25$</td> <td colspan="3">2</td> </tr> <tr> <td>$0.25 < \Phi$</td> <td colspan="3">0</td> </tr> </tbody> </table>	Zone Size(mm)	Acceptable Qty			A	B	C	$\Phi \leq 0.1$	Ignore			$0.10 < \Phi \leq 0.15$	3			$0.15 < \Phi \leq 0.25$	2			$0.25 < \Phi$	0			Minor
Zone Size(mm)	Acceptable Qty																									
	A	B	C																							
$\Phi \leq 0.1$	Ignore																									
$0.10 < \Phi \leq 0.15$	3																									
$0.15 < \Phi \leq 0.25$	2																									
$0.25 < \Phi$	0																									

Dim Spots Circle shaped and dim edged defects	3.			Minor	
	2. Zone		Acceptable Qty		
	Size(mm)	A	B		C
	$\Phi \leq 0.2$	Ignore			Ignore
	$0.20 < \Phi \leq 0.40$	2			
$0.40 < \Phi \leq 0.60$	1				
$0.60 < \Phi$	0				

4.2 Cosmetic Defect

Item No	Items to be inspected	Inspection Standard			Classification of defects		
4.2.2	Line defect Black line, White line, Foreign material on polarizer	size(mm)		Acceptable Qty		Minor	
	L(Length)	W(Width)	zone				
Ignore	$W \leq 0.02$	A	B	C	Ignore		
$L \leq 3.0$	$0.02 < W \leq 0.03$	2					
$L \leq 2.0$	$0.03 < W \leq 0.05$	1					
	$0.05 < W$	Define as spot defect					
	Foreign material on TP film	size(mm)		Acceptable Qty			
		L(Length)	W(Width)	zone			
		Ignore	$W \leq 0.03$	A	B	C	Ignore
		$L \leq 5.0$	$0.03 < W \leq 0.05$	3			
			$0.05 < W$	Define as spot defect			
		If the scratch can be seen after mobile phone cover assembling or in the operating condition, judge by the line defect of 4.2.2. If the scratch can be seen only in non-operating condition or some special angle, judge by the following.					

4.2.3	Dim line defect Polarizer scratch TP film scratch	Size(mm)		Acceptable Qty			Minor
		L(Length)	W(Width)	Zone			
				A	B	C	
		Ignore	$W \leq 0.03$	Ignore		Ignore	
		$5.0 < L \leq 10.0$	$0.03 < W \leq 0.05$	2			
		$L \leq 5.0$	$0.05 < W \leq 0.08$	1			
	$0.08 < W$	0					
4.2.4	Polarize Air bubble	Air bubbles between glass & polarizer					Minor
		2. Zone Size(mm)	Acceptable Qty				
			A	B	C		
		$\Phi \leq 0.2$	Ignore		Ignore		
		$0.20 < \Phi \leq 0.30$	2				
		$0.30 < \Phi \leq 0.50$	1				
$0.50 < \Phi$	0						

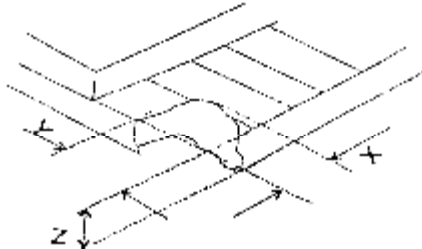

4.3. Cosmetic Defect

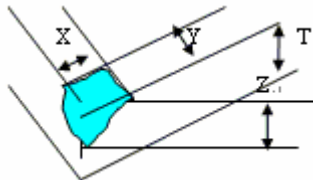
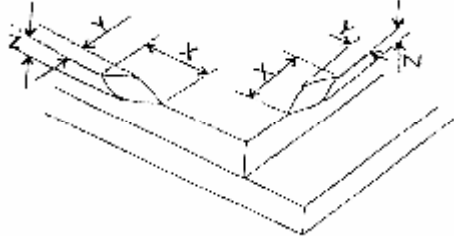
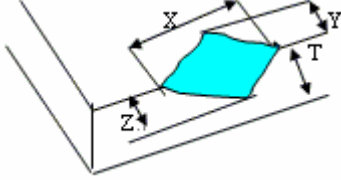
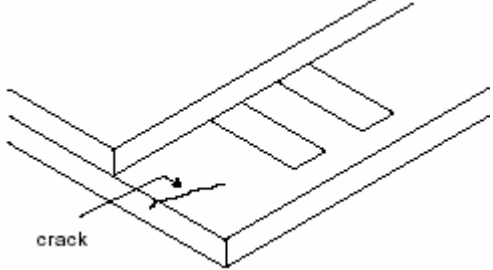
Item No	Items to be inspected	Inspection Standard	Classification of defects						
		(i) Chips on corner A:LCD Glass defect  <table border="1" data-bbox="518 1534 1141 1635"> <tr> <td>X</td> <td>Y</td> <td>Z</td> </tr> <tr> <td>≤ 2.0</td> <td>$\leq S$</td> <td>Disregard</td> </tr> </table> <p>Notes: S=contact pad length Chips on the corner of terminal shall not be allowed to extend into the ITO pad or expose perimeter seal.</p>	X	Y	Z	≤ 2.0	$\leq S$	Disregard	Minor
X	Y	Z							
≤ 2.0	$\leq S$	Disregard							

4.3.5	Glass defect	<p>B:TP Glass defect</p>  <table border="1" style="margin-left: auto; margin-right: auto;"> <thead> <tr> <th>X(mm)</th> <th>Y(mm)</th> <th>Z(mm)</th> </tr> </thead> <tbody> <tr> <td style="text-align: center;">≤ 3.0</td> <td style="text-align: center;">≤ 3.0</td> <td style="text-align: center;">Disregard</td> </tr> </tbody> </table>	X(mm)	Y(mm)	Z(mm)	≤ 3.0	≤ 3.0	Disregard					
		X(mm)	Y(mm)	Z(mm)									
		≤ 3.0	≤ 3.0	Disregard									
<p>(ii) Usual surface cracks</p> <p>A:LCD Glass defect</p>  <table border="1" style="margin-left: auto; margin-right: auto;"> <thead> <tr> <th>X</th> <th>Y</th> <th>Z</th> </tr> </thead> <tbody> <tr> <td style="text-align: center;">≤ 3.0</td> <td style="text-align: center;"><Inner border line of the seal</td> <td style="text-align: center;">Disregard</td> </tr> </tbody> </table> <p>B:TP Glass defect</p>  <table border="1" style="margin-left: auto; margin-right: auto;"> <thead> <tr> <th>X(mm)</th> <th>Y(mm)</th> <th>Z(mm)</th> </tr> </thead> <tbody> <tr> <td style="text-align: center;">≤ 6.0</td> <td style="text-align: center;"><2.0</td> <td style="text-align: center;">Disregard</td> </tr> </tbody> </table>	X	Y	Z	≤ 3.0	<Inner border line of the seal	Disregard	X(mm)	Y(mm)	Z(mm)	≤ 6.0	<2.0	Disregard	Minor
X	Y	Z											
≤ 3.0	<Inner border line of the seal	Disregard											
X(mm)	Y(mm)	Z(mm)											
≤ 6.0	<2.0	Disregard											
<p>(iii) Crack</p> <p>Cracks tend to break are not allowed.</p> 	Major												

**4.4 Parts Defect**

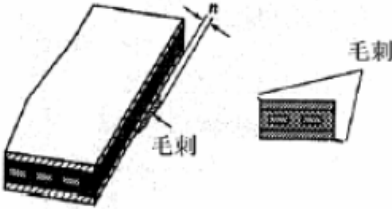
Item No	Items to be inspected	Inspection Standard	Classification of defects
	4.4.1 Parts contraposition	1、 Not allow IC and FPC/heat-seal lead width is more than 50% beyond lead pattern. 2、 Not allow chip or solder component is off center more than 50% of the pad outline.	Major
	4.4.2 SMT	According to the <Acceptability of electronic assemblies> IPC-A-610C class 2 standard. Component missing or function defect are Major defect, the others are Minor defect.	

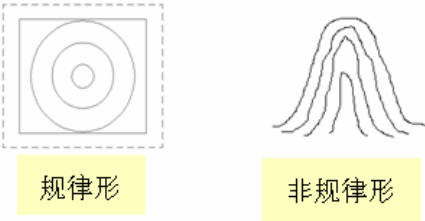
<p>4.4.3 TP Defect</p>	<p>1、 Pattern font: Pattern fonts are clear and symmetrical, pattern fonts filter lightly are allowed; The font line is not allow to thinner or thicker than 1/3of normal size, and swing is not more than 0.1mm. the line is smooth and not broken.</p>  <p>图案字体 Pattern font</p> <p>2、 The wing forward in the side of Visual Area: The length of wing forward inside of the Visual Area: $n \leq 0.2\text{mm}$; Not excess 3 point, and the distance $D \geq 20\text{mm}$.</p>  <p>3、 Film impression:With operation, must be invisibility.</p> <p>4、 Touch panel knob: if writing function normally,it could be allowed.</p>  <p>TP鼓 TP knob</p> <p>5、 Newton ring Without operation, the color circle of Regularity or Non-regularity from the normal or slope angle of view.</p> <p>1、 Regularity: The area of the newton ring is less than 1/3 area of the touch panel; and no character affected and line distorted after touch panel lightening. It's ok.</p> <p>2、 Non-regularity : The area of the Newton ring is less than the 1/2 area of touch panel with lightening. And no character affected and line</p> 	<p>Minor</p>
----------------------------	---	--------------

www.DataSheet4U.com

n PRECAUTIONS FOR USING LCD MODULES

Handing Precautions

- 1) The display panel is made of glass and polarizer. As glass is fragile. It tends to become or chipped during

■ PRECAUTIONS FOR USING LCD MODULES

Handling Precautions

(1) The display panel is made of glass and polarizer. As glass is fragile. It tends to become or chipped during handling especially on the edges. Please avoid dropping or jarring. Do not subject it to a mechanical shock by dropping it or impact.

(2) If the display panel is damaged and the liquid crystal substance leaks out, be sure not to get any in your mouth. If the substance contacts your skin or clothes, wash it off using soap and water.

(3) Do not apply excessive force to the display surface or the adjoining areas since this may cause the color tone to vary. Do not touch the display with bare hands. This will stain the display area and degraded insulation between terminals (some cosmetics are determined to the polarizer).

(4) The polarizer covering the display surface of the LCD module is soft and easily scratched. Handle this polarizer carefully. Do not touch, push or rub the exposed polarizers with anything harder than an HB pencil lead (glass, tweezers, etc.). Do not put or attach anything on the display area to avoid leaving marks on. Condensation on the surface and contact with terminals due to cold will damage, stain or dirty the polarizer. After products are tested at low temperature they must be warmed up in a container before coming is contacting with room temperature air.

(5) If the display surface becomes contaminated, breathe on the surface and gently wipe it with a soft dry cloth. If it is heavily contaminated, moisten cloth with one of the following solvents

- Isopropyl alcohol
- Ethyl alcohol

Do not scrub hard to avoid damaging the display surface.

(6) Solvents other than those above-mentioned may damage the polarizer. Especially, do not use the following.

- Water
- Ketone
- Aromatic solvents

Wipe off saliva or water drops immediately, contact with water over a long period of time may cause deformation or color fading. Avoid contacting oil and fats.

(7) Exercise care to minimize corrosion of the electrode. Corrosion of the electrodes is accelerated by water droplets, moisture condensation or a current flow in a high-humidity environment.

(8) Install the LCD Module by using the mounting holes. When mounting the LCD module make sure it is free of twisting, warping and distortion. In particular, do not forcibly pull or bend the I/O cable or the backlight cable.

(9) Do not attempt to disassemble or process the LCD module.

(10) NC terminal should be open. Do not connect anything.

(11) If the logic circuit power is off, do not apply the input signals.

(12) Electro-Static Discharge Control, Since this module uses a CMOS LSI, the same careful attention should be paid to electrostatic discharge as for an ordinary CMOS IC. To prevent destruction of the elements by static electricity, be careful to maintain an optimum work environment.

- Before remove LCM from its packing case or incorporating it into a set, be sure the module and your body have the same electric potential. Be sure to ground the body when handling the LCD modules.

- Tools required for assembling, such as soldering irons, must be properly grounded. make certain the AC power source for the soldering iron does not leak. When using an electric screwdriver to attach LCM, the screwdriver should be of ground potentiality to minimize as much as possible any transmission of electromagnetic waves produced sparks coming from the commutator of the motor.

- To reduce the amount of static electricity generated, do not conduct assembling and other work under dry conditions. To reduce the generation of static electricity be careful that the air in the work is not too dried. A relative humidity of 50%-60% is recommended. As far as possible make the electric potential of your work clothes and that of the work bench the ground potential

- The LCD module is coated with a film to protect the display surface. Exercise care when peeling off this protective film since static electricity may be generated



(13) Since LCM has been assembled and adjusted with a high degree of precision, avoid applying excessive shocks to the module or making any alterations or modifications to it.

- Do not alter, modify or change the shape of the tab on the metal frame.
- Do not make extra holes on the printed circuit board, modify its shape or change the positions of components to be attached.
- Do not damage or modify the pattern writing on the printed circuit board.
- Absolutely do not modify the zebra rubber strip (conductive rubber) or heat seal connector.
- Except for soldering the interface, do not make any alterations or modifications with a soldering iron.
- Do not drop, bend or twist LCM.

Handling precaution for LCM

LCM is easy to be damaged.
Please note below and be careful for handling!

Correct handling:



As above picture, please handle with anti-static gloves around LCM edges.

Incorrect handling:

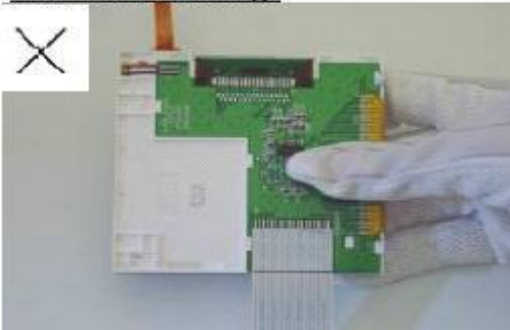

Please don't touch IC directly.

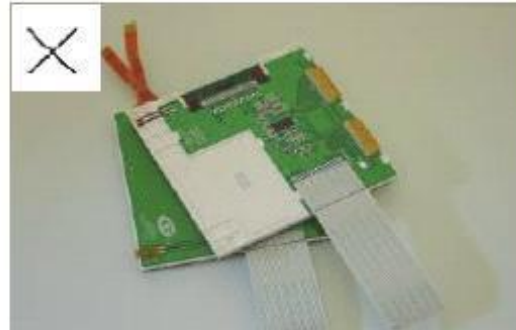

Please don't stack LCM.

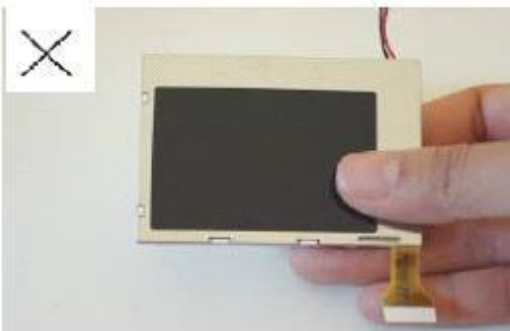

Please don't hold the surface of panel.

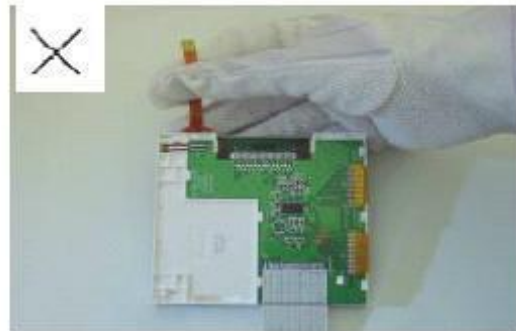

Please don't stretch interface of output, such as FPC cable.

Handling precaution for LCD

LCD is easy to be damaged.
Please note below and be careful for handling!

Correct handling:

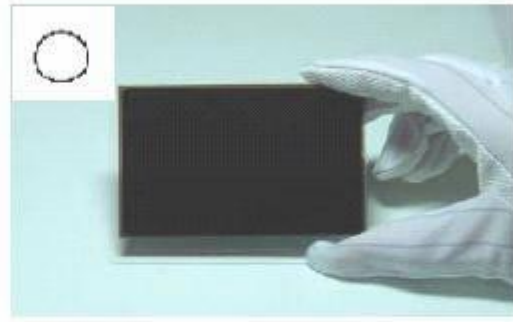

As above photo, please handle with anti-static gloves around LCD edges.

Incorrect handling:



Please don't stack the LCDS.

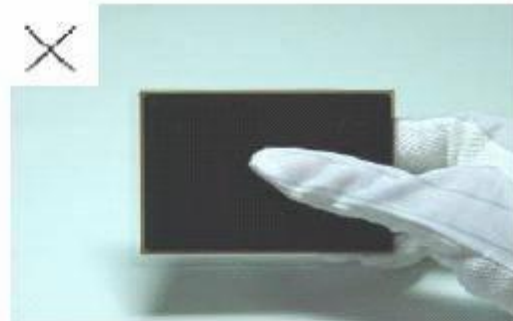

Please don't hold the surface of LCD.

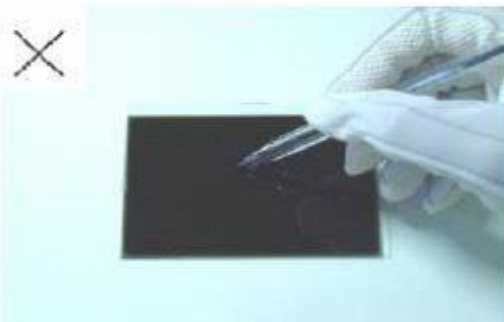

Please don't operate with sharp stick such as pens.

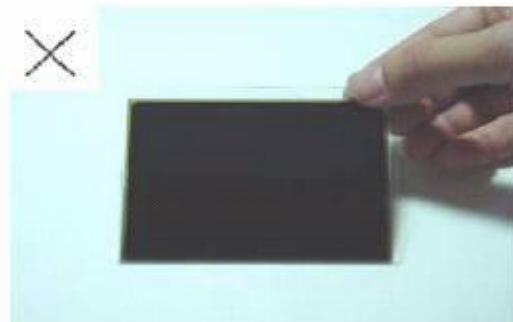

Please don't touch ITO glass without anti-static gloves.

Storage Precautions

When storing the LCD modules, the following precaution is necessary.

- (1) Store them in a sealed polyethylene bag. If properly sealed, there is no need for the dessicant.
- (2) Store them in a dark place. Do not expose to sunlight or fluorescent light, keep the temperature between 0°C and 35°C, and keep the relative humidity between 40%RH and 60%RH.
- (3) The polarizer surface should not come in contact with any other objects. (We advise you to store them in the anti-static electricity container in which they were shipped.

Others

Liquid crystals solidify under low temperature (below the storage temperature range) leading to defective orientation or the generation of air bubbles (black or white). Air bubbles may also be generated if the module is subject to a low temperature.

If the LCD modules have been operating for a long time showing the same display patterns, the display patterns may remain on the screen as ghost images and a slight contrast irregularity may also appear. A normal operating status can be regained by suspending use for some time. It should be noted that this phenomenon does not adversely affect performance reliability.

To minimize the performance degradation of the LCD modules resulting from destruction caused by static electricity etc., exercise care to avoid holding the following sections when handling the modules.

- Exposed area of the printed circuit board.
- Terminal electrode sections.

USING LCD MODULES

Installing LCD Modules

The hole in the printed circuit board is used to fix LCM as shown in the picture below. Attend to the following items when installing the LCM.

- (1) Cover the surface with a transparent protective plate to protect the polarizer and LC cell.

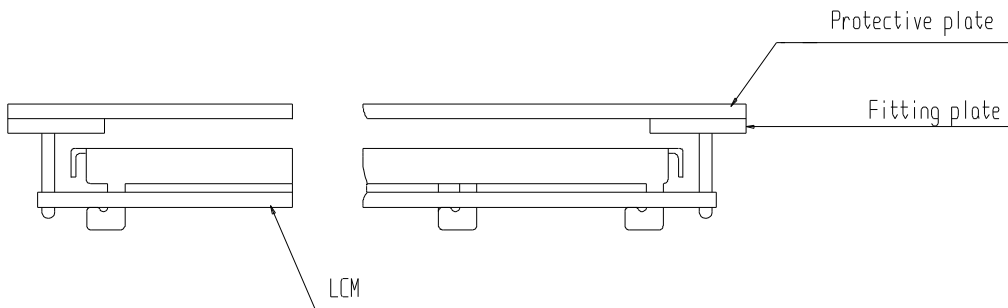

- (2) When assembling the LCM into other equipment, the spacer to the bit between the LCM and the fitting plate should have enough height to avoid causing stress to the module surface, refer to the individual specifications for measurements. The measurement tolerance should be ± 0.1 mm.

Precaution for assemble the module with BTB connector:

Please note the position of the male and female connector position, don't assemble or assemble like the method which the following picture shows

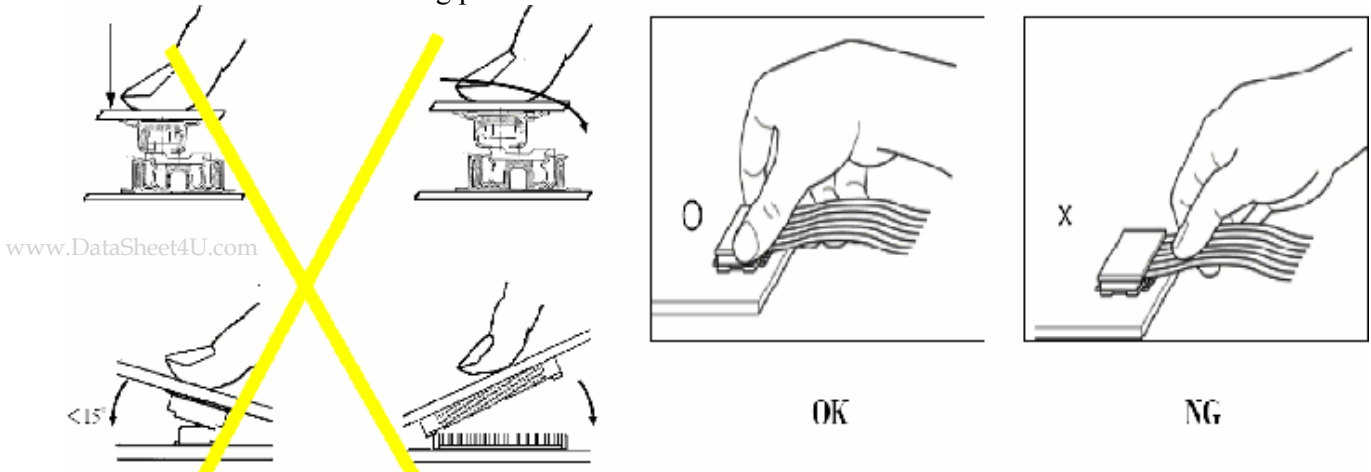

**Precaution for soldering to the LCM**

	Hand soldering	Machine drag soldering	Machine press soldering
No ROHS product	290°C ~350°C. Time : 3-5S.	330°C ~350°C. Speed : 4-8 mm/s.	300°C ~330°C. Time : 3-6S. Press: 0.8~1.2Mpa
ROHS product	340°C ~370°C. Time : 3-5S.	350°C ~370°C. Time : 4-8 mm/s.	330°C ~360°C. Time : 3-6S. Press: 0.8~1.2Mpa

- 1) If soldering flux is used, be sure to remove any remaining flux after finishing to soldering operation. (This does not apply in the case of a non-halogen type of flux.) It is recommended that you protect the LCD surface with a cover during soldering to prevent any damage due to flux spatters.
- 2) When soldering the electroluminescent panel and PC board, the panel and board should not be detached more than three times. This maximum number is determined by the temperature and time conditions mentioned above, though there may be some variance depending on the temperature of the soldering iron.
- 3) When remove the electroluminescent panel from the PC board, be sure the solder has completely melted, the soldered pad on the PC board could be damaged.

Precautions for Operation

- 1) Viewing angle varies with the change of liquid crystal driving voltage (VLCD). Adjust VLCD to show the best contrast.
- 2) It is an indispensable condition to drive LCD's within the specified voltage limit since the higher voltage than the limit cause the shorter LCD life. An electrochemical reaction due to direct current causes LCD's undesirable deterioration, so that the use of direct current drive should be avoided.
- 3) Response time will be extremely delayed at lower temperature than the operating temperature range and on the other hand at higher temperature LCD's show dark color in them. However those phenomena do not mean malfunction or out of order with LCD's, Which will come back in the specified operating temperature.
- 4) If the display area is pushed hard during operation, the display will become abnormal. However, it will return to normal if it is turned off and then back on.
- 5) A slight dew depositing on terminals is a cause for electro-chemical reaction resulting in terminal open circuit. Usage under the maximum operating temperature, 50%RH or less is required.
- 6) Input logic voltage before apply analog high voltage such as LCD driving voltage when power on. Remove analog high voltage before logic voltage when power off the module. Input each signal after the positive/negative voltage becomes stable.
- 7) Please keep the temperature within specified range for use and storage. Polarization degradation, bubble generation or polarizer peel-off may occur with high temperature and high humidity.

**Safety**

(1) It is recommended to crush damaged or unnecessary LCDs into pieces and wash them off with solvents such as acetone and ethanol, which should later be burned.

(2) If any liquid leaks out of a damaged glass cell and comes in contact with the hands, wash off thoroughly with soap and water.

Limited Warranty

Unless agreed between Multi-Inno and customer, Multi-Inno will replace or repair any of its LCD modules which are found to be functionally defective when inspected in accordance with Multi-Inno LCD acceptance standards (copies available upon request) for a period of one year from date of production. Cosmetic/visual defects must be returned to Multi-Inno within 90 days of shipment. Confirmation of such date shall be based on data code on product. The warranty liability of Multi-Inno limited to repair and/or replacement on the terms set forth above. Multi-Inno will not be responsible for any subsequent or consequential events.

Return LCM under warranty

No warranty can be granted if the precautions stated above have been disregarded. The typical examples of violations are :

- Broken LCD glass.
- PCB eyelet is damaged or modified.
- PCB conductors damaged.
- Circuit modified in any way, including addition of components.
- PCB tampered with by grinding, engraving or painting varnish.
- Soldering to or modifying the bezel in any manner.

Module repairs will be invoiced to the customer upon mutual agreement. Modules must be returned with sufficient description of the failures or defects. Any connectors or cable installed by the customer must be removed completely without damaging the PCB eyelet, conductors and terminals.

■ PACKING SPECIFICATION

TBD

■ PRIOR CONSULT MATTER

1. ① For Multi-Inno standard products, we keep the right to change material, process ... for improving the product property without notice on our customer.
- ② For OEM products, if any change needed which may affect the product property, we will consult with our customer in advance.
2. If you have special requirement about reliability condition, please let us know before you start the test on our samples.

www.DataSheet4U.com