

N-Channel Enhancement Mode Power MOSFET

■ Features

- Low On-resistance
- Single Drive Requirement
- Surface Mount Package

■ General Description

The Advanced Power MOSFET provides the designer with the best combination of fast switching, ruggedized device design, ultra low on-resistance and cost-effectiveness.

■ Product Summary

BV_{DSS} (V)	$r_{DS(on)}$ (m Ω)	I_D (A)
60	90	3.5

■ Pin Assignments

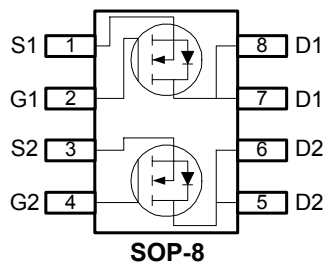

■ Pin Descriptions

Pin Name	Description
S1/2	Source
G1/2	Gate
D1/2	Drain

■ Ordering information

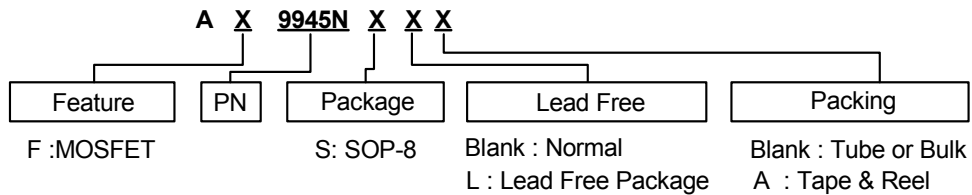



N-Channel Enhancement Mode Power MOSFET

■ Absolute Maximum Ratings

Symbol	Parameter	Rating	Units
V_{DS}	Drain-Source Voltage	60	V
V_{GS}	Gate-Source Voltage	± 25	V
I_D	Continuous Drain Current (Note 1)	$T_A=25^\circ\text{C}$	3.5
		$T_A=70^\circ\text{C}$	2.8
I_{DM}	Pulsed Drain Current (Note 2)	20	A
P_D	Total Power Dissipation	$T_A=25^\circ\text{C}$	2
	Linear Derating Factor		0.016
T_{STG}	Storage Temperature Range	-55 to 150	$^\circ\text{C}$
T_J	Operating Junction Temperature Range	-55 to 150	$^\circ\text{C}$

■ Thermal Resistance Ratings

Symbol	Parameter	Value	Units
Rthj-a	Thermal Resistance Junction-Ambient (Note 1) Max.	62.5	$^\circ\text{C}/\text{W}$

Note 1: Surface mounted on 1 in² copper pad of FR4 board, $t_s \leq 10\text{sec}$; $135^\circ\text{C}/\text{W}$ when mounted on Min. copper pad.

Note 2: Pulse width limited by Max. junction temperature.

■ Electrical Characteristics at $T_J=25^\circ\text{C}$ (unless otherwise specified)

Symbol	Parameter	Test Conditions	Min.	Typ.	Max.	Units
BV_{DSS}	Drain-Source Breakdown Voltage	$V_{GS}=0\text{V}, I_D=250\mu\text{A}$	60	-	-	V
$\Delta BV_{DSS}/\Delta T_J$	Breakdown Voltage Temperature Coefficient	Reference to 25°C , $I_D=1\text{mA}$	-	0.04	-	$\text{V}/^\circ\text{C}$
$R_{DS(on)}$	Static Drain-Source On-Resistance (Note 3)	$V_{GS}=10\text{V}, I_D=3\text{A}$	-	-	90	m Ω
		$V_{GS}=4.5\text{V}, I_D=2\text{A}$	-	-	120	m Ω
$V_{GS(th)}$	Gate Threshold Voltage	$V_{DS}=V_{GS}, I_D=250\mu\text{A}$	1	-	3	V
g_{fs}	Forward Transconductance	$V_{DS}=10\text{V}, I_D=3\text{A}$	-	6	-	S
I_{DSS}	Drain-Source Leakage Current	$V_{DS}=60\text{V}, V_{GS}=0\text{V}, T_J=25^\circ\text{C}$	-	-	10	μA
		$V_{DS}=48\text{V}, V_{GS}=0\text{V}, T_J=70^\circ\text{C}$	-	-	25	μA
I_{GSS}	Gate-Source Leakage	$V_{GS}=\pm 25\text{V}$	-	-	± 100	nA
Q_g	Total Gate Charge (Note 3)	$I_D=3\text{A}$	-	6	10	nC
Q_{gs}	Gate-Source Charge	$V_{DS}=48\text{V}$	-	2	-	nC
Q_{gd}	Gate-Drain ("Miller") Charge	$V_{GS}=4.5\text{V}$	-	3	-	nC
$t_{d(on)}$	Turn-On Delay Time (Note 3)	$V_{DS}=30\text{V}$	-	6	-	ns
t_r	Rise Time	$I_D=1\text{A}$	-	5	-	ns
$t_{d(off)}$	Turn-Off Delay Time	$R_G=3.3\Omega, V_{GS}=10\text{V}$	-	16	-	ns
t_f	Fall-Time	$R_D=30\Omega$	-	3	-	ns
C_{iss}	Input Capacitance	$V_{GS}=0\text{V}$	-	510	810	pF
C_{oss}	Output Capacitance	$V_{DS}=25\text{V}$	-	55	-	pF
C_{rss}	Reverse Transfer Capacitance	$f=1.0\text{MHz}$	-	35	-	pF
R_G	Gate Resistance	$f=1.0\text{MHz}$	-	1.3	-	Ω

■ Source-Drain Diode

Symbol	Parameter	Test Conditions	Min.	Typ.	Max.	Units
V_{SD}	Forward On Voltage (Note 3)	$I_S=1.7\text{A}, V_{GS}=0\text{V}$	-	-	1.2	V
t_{rr}	Reverse Recovery Time (Note 3)	$I_S=4\text{A}, V_{GS}=0\text{V}$	-	27	-	ns
Q_{rr}	Reverse Recovery Charge	$di/dt=100\text{A}/\mu\text{s}$	-	32	-	nC

Note3: Pulse width $\leq 300\mu\text{s}$, duty cycle $\leq 2\%$.

N-Channel Enhancement Mode Power MOSFET

■ Typical Performance Characteristics

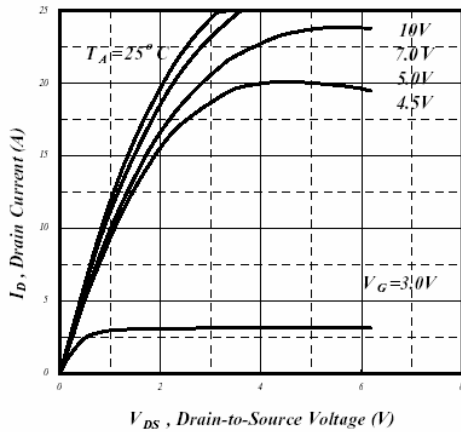

Fig 1. Typical Output Characteristics

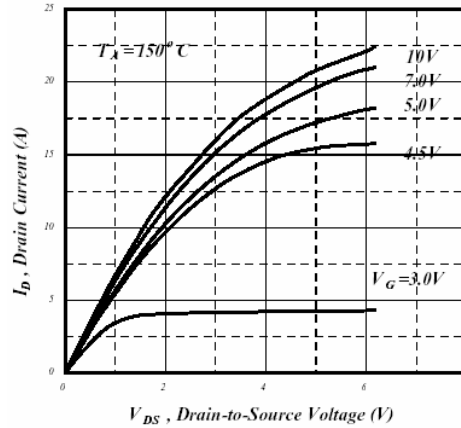

Fig 2. Typical Output Characteristics

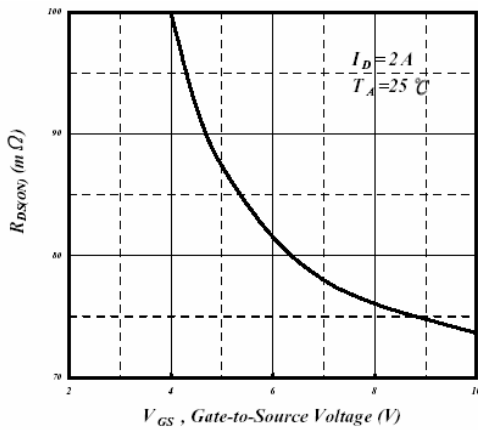

Fig 3. On-Resistance v.s. Gate Voltage

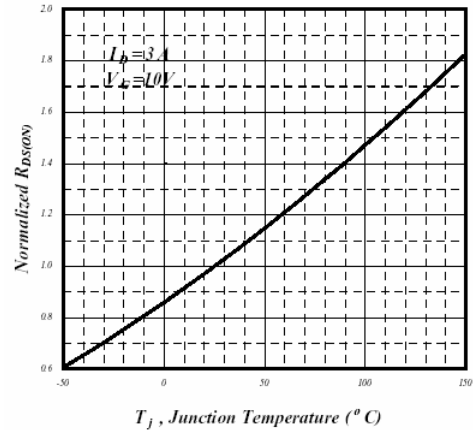

Fig 4. Normalized On-Resistance v.s. Junction Temperature

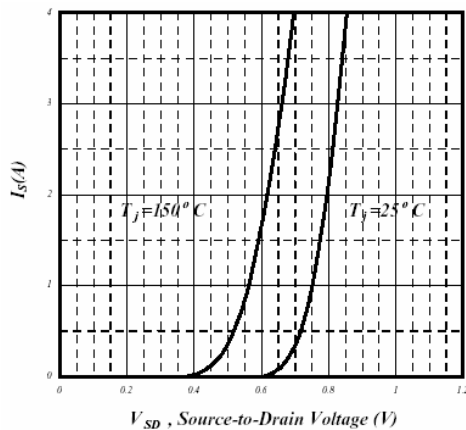

Fig 5. Forward Characteristic of Reverse Diode

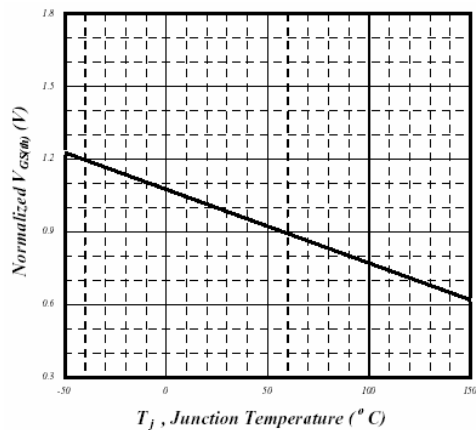

Fig 6. Gate Threshold Voltage v.s. Junction Temperature

N-Channel Enhancement Mode Power MOSFET

■ Typical Performance Characteristics (Continued)

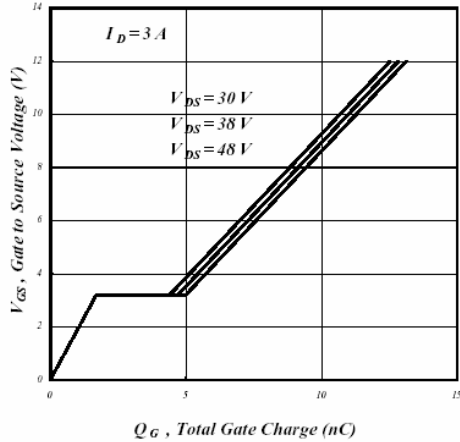

Fig 7. Gate Charge Characteristics

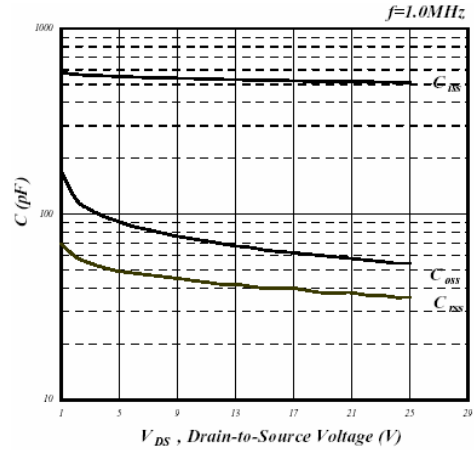

Fig 8. Typical Capacitance Characteristics

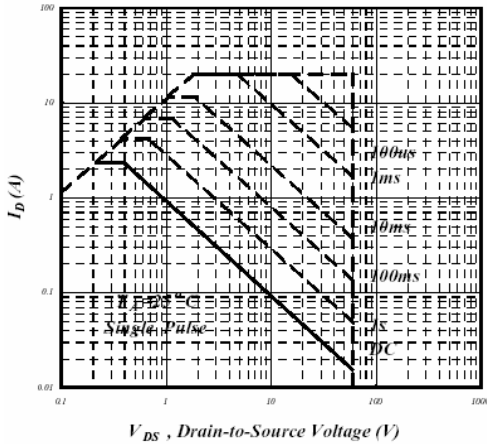

Fig 9. Maximum Safe Operating Area

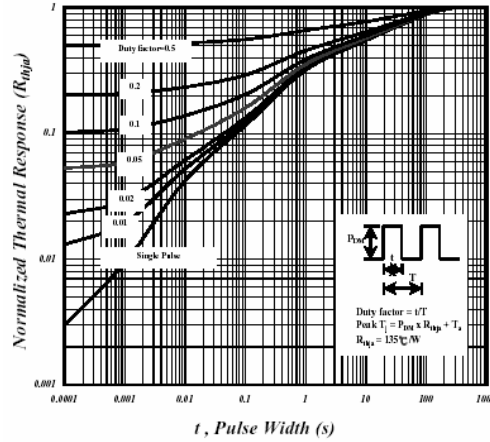

Fig 10. Effective Transient Thermal Impedance

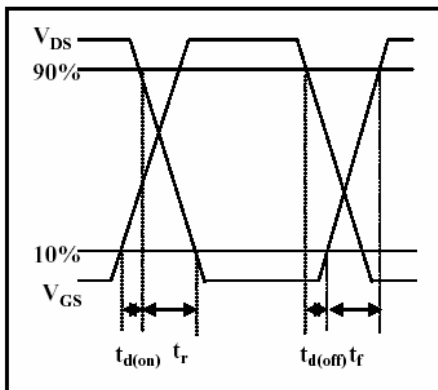

Fig 11. Switching Time Waveform

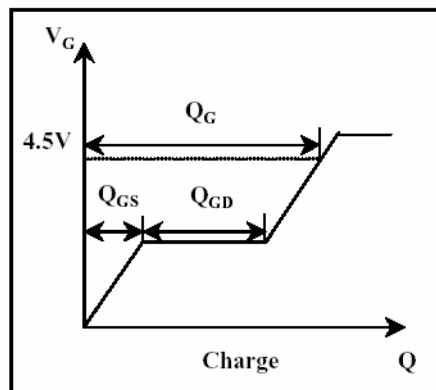
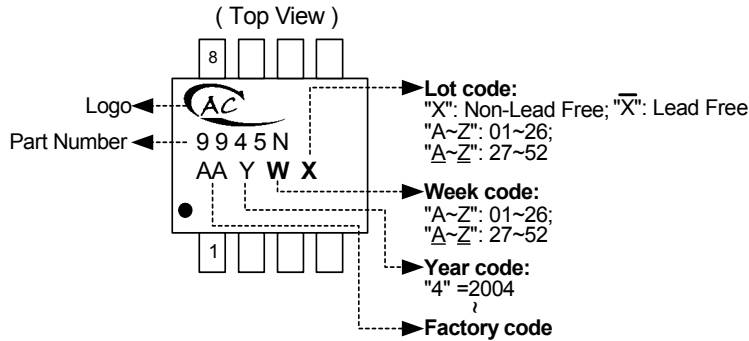

Fig 12. Gate Charge Waveform

N-Channel Enhancement Mode Power MOSFET

■ Marking Information

SOP-8L



■ Package Information

Package Type: SOP-8L

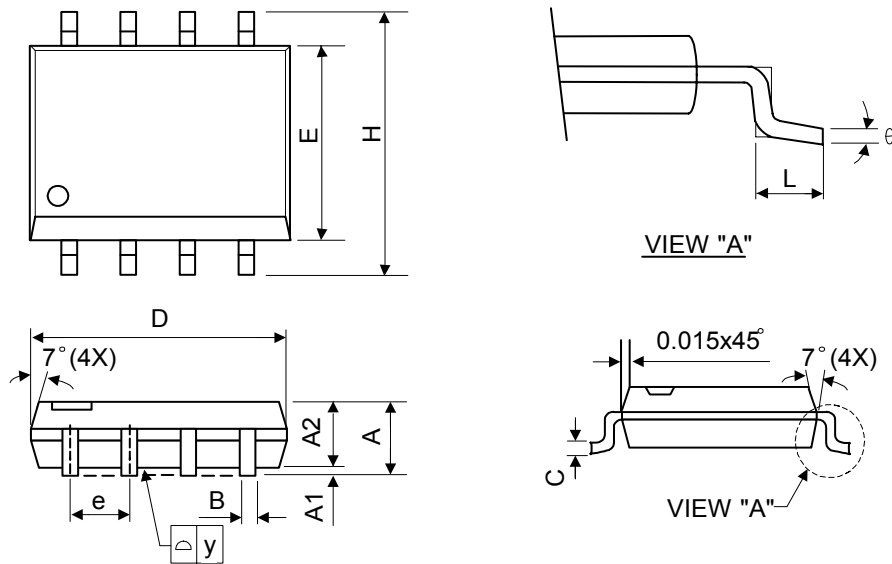

Symbol	Dimensions In Millimeters			Dimensions In Inches		
	Min.	Nom.	Max.	Min.	Nom.	Max.
A	1.40	1.60	1.75	0.055	0.063	0.069
A1	0.10	-	0.25	0.040	-	0.100
A2	1.30	1.45	1.50	0.051	0.057	0.059
B	0.33	0.41	0.51	0.013	0.016	0.020
C	0.19	0.20	0.25	0.0075	0.008	0.010
D	4.80	5.05	5.30	0.189	0.199	0.209
E	3.70	3.90	4.10	0.146	0.154	0.161
e	-	1.27	-	-	0.050	-
H	5.79	5.99	6.20	0.228	0.236	0.244
L	0.38	0.71	1.27	0.015	0.028	0.050
y	-	-	0.10	-	-	0.004
θ	0°	-	8°	0°	-	8°